



## USER GUIDE

PTP 550 Series  
System Release 4.4.2



**Accuracy**

While reasonable efforts have been made to assure the accuracy of this document, Cambium Networks assumes no liability resulting from any inaccuracies or omissions in this document, or from use of the information obtained herein. Cambium reserves the right to make changes to any products described herein to improve reliability, function, or design, and reserves the right to revise this document and to make changes from time to time in content hereof with no obligation to notify any person of revisions or changes. Cambium does not assume any liability arising out of the application or use of any product, software, or circuit described herein; neither does it convey license under its patent rights or the rights of others. It is possible that this publication may contain references to, or information about Cambium products (machines and programs), programming, or services that are not announced in your country. Such references or information must not be construed to mean that Cambium intends to announce such Cambium products, programming, or services in your country.

**Copyrights**

This document, Cambium products, and 3<sup>rd</sup> Party software products described in this document may include or describe copyrighted Cambium and other 3<sup>rd</sup> Party supplied computer programs stored in semiconductor memories or other media. Laws in the United States and other countries preserve for Cambium, its licensors, and other 3<sup>rd</sup> Party supplied software certain exclusive rights for copyrighted material, including the exclusive right to copy, reproduce in any form, distribute and make derivative works of the copyrighted material. Accordingly, any copyrighted material of Cambium, its licensors, or the 3<sup>rd</sup> Party software supplied material contained in the Cambium products described in this document may not be copied, reproduced, reverse engineered, distributed, merged or modified in any manner without the express written permission of Cambium. Furthermore, the purchase of Cambium products shall not be deemed to grant either directly or by implication, estoppel, or otherwise, any license under the copyrights, patents or patent applications of Cambium or other 3<sup>rd</sup> Party supplied software, except for the normal non-exclusive, royalty free license to use that arises by operation of law in the sale of a product.

**Restrictions**

Software and documentation are copyrighted materials. Making unauthorized copies is prohibited by law. No part of the software or documentation may be reproduced, transmitted, transcribed, stored in a retrieval system, or translated into any language or computer language, in any form or by any means, without prior written permission of Cambium.

**License Agreements**

The software described in this document is the property of Cambium and its licensors. It is furnished by express license agreement only and may be used only in accordance with the terms of such an agreement.

**High Risk Materials**

Cambium and its supplier(s) specifically disclaim any express or implied warranty of fitness for any high risk activities or uses of its products including, but not limited to, the operation of nuclear facilities, aircraft navigation or aircraft communication systems, air traffic control, life support, or weapons systems ("High Risk Use"). Any High Risk is unauthorized, is made at your own risk and you shall be responsible for any and all losses, damage or claims arising out of any High Risk Use.

© 2018 Cambium Networks Limited. All Rights Reserved.

---

# Contents

---

<b>About This User Guide .....</b>	<b>1</b>
Contacting Cambium Networks .....	1
Purpose .....	1
Cross references .....	2
Feedback .....	2
<b>Important regulatory information .....</b>	<b>3</b>
USA specific information .....	3
Canada specific information .....	3
Renseignements spécifiques au Canada .....	4
EU Declaration of Conformity .....	4
Application firmware .....	4
Specific expertise and training for professional installers .....	4
External antennas .....	5
Antennas externes .....	5
Ethernet networking skills .....	5
Lightning protection .....	5
Training .....	5
<b>Problems and warranty .....</b>	<b>6</b>
Reporting problems .....	6
Repair and service .....	6
Hardware warranty .....	6
<b>Security advice .....</b>	<b>7</b>
<b>Warnings, cautions, and notes .....</b>	<b>8</b>
Warnings .....	8
Cautions .....	8
Notes .....	8
<b>Caring for the environment .....</b>	<b>9</b>
In EU countries .....	9
In non-EU countries .....	9
<b>Chapter 1: Product description .....</b>	<b>1-1</b>
<b>Overview of the PTP 550 Series .....</b>	<b>1-2</b>
Purpose .....	1-2
Key features .....	1-2
Frequency bands .....	1-3
Typical bridge deployment .....	1-4
Hardware overview .....	1-5
<b>Wireless operation .....</b>	<b>1-7</b>
Channel Bonding .....	1-7
Time division duplexing .....	1-7
Link Scheduler .....	1-9

OFDM and channel bandwidth .....	1-9
Adaptive modulation.....	1-9
MIMO .....	1-10
DFS Tuning.....	1-10
Encryption .....	1-11
Regulatory bands.....	1-11
PTP networks.....	1-12
Ethernet bridging.....	1-13
Ethernet ports .....	1-13
Data network.....	1-13
Protocol model.....	1-13
Quality of Service (QoS).....	1-14
System management .....	1-15
Management agent.....	1-15
Network management .....	1-16
SNMP.....	1-17
Network Time Protocol (NTP) .....	1-17
Trial Config .....	1-18
System logging (syslog) .....	1-19
Software upgrade.....	1-19
cnMaestro Zero-Touch .....	1-20
<b>Chapter 2: System hardware.....</b>	<b>2-1</b>
Outdoor unit (ODU) .....	2-2
ODU description .....	2-2
PTP 550 Integrated ODU .....	2-2
PTP 550 Connectorized ODU .....	2-3
ODU accessories.....	2-5
Mounting bracket.....	2-5
ODU interfaces .....	2-6
ODU specifications .....	2-8
Power supply units (PSU).....	2-9
PSU description .....	2-9
PSU part numbers .....	2-10
AC Power Injector interfaces.....	2-10
PSU specifications .....	2-10
Antennas and antenna cabling .....	2-12
Antenna requirements.....	2-12
RF cable and connectors .....	2-12
Antenna accessories.....	2-12
Ethernet cabling.....	2-13
Ethernet standards and cable lengths.....	2-13
Outdoor copper Cat5e Ethernet cable .....	2-14
Cable grounding kit .....	2-15
RJ45 connectors and spare glands .....	2-16
Cable hoisting grip.....	2-16
Drop cable tester.....	2-17

Indoor Cat5e cable .....	2-17
SFP module kits .....	2-17
Optical cable and connectors .....	2-19
Surge suppression unit .....	2-20
Gigabit Ethernet Surge Suppressor .....	2-20
<b>Chapter 3: System planning.....</b>	<b>3-21</b>
Site planning .....	3-22
Grounding and lightning protection .....	3-22
Lightning protection zones .....	3-22
Site grounding system .....	3-23
ODU and external antenna location .....	3-24
ODU wind loading .....	3-24
PSU AC power supply .....	3-25
PSU location .....	3-25
Drop cable grounding points .....	3-25
Radio spectrum planning .....	3-26
General wireless specifications .....	3-26
Regulatory limits .....	3-27
Conforming to the limits .....	3-27
Available spectrum .....	3-27
Channel bandwidth .....	3-28
Link planning .....	3-29
LINKPlanner .....	3-29
Range and obstacles .....	3-29
Path loss .....	3-29
Adaptive modulation .....	3-30
Planning for connectorized units .....	3-31
When to install connectorized units .....	3-31
Choosing external antennas .....	3-31
Data network planning .....	3-33
Ethernet interfaces .....	3-33
IP interface .....	3-33
Green Ethernet switches .....	3-33
Network management planning .....	3-34
Enabling SNMP .....	3-34
Security planning .....	3-35
Planning for NTP operation .....	3-35
System threshold .....	3-36
<b>Chapter 4: Legal and regulatory information .....</b>	<b>4-1</b>
Cambium Networks end user license agreement .....	4-2
Definitions .....	4-2
Acceptance of this agreement .....	4-2
Grant of license .....	4-2
Conditions of use .....	4-3
Title and restrictions .....	4-4
Confidentiality .....	4-4

Right to use Cambium’s name.....	4-5
Transfer .....	4-5
Updates .....	4-5
Maintenance .....	4-5
Disclaimer.....	4-6
Limitation of liability.....	4-6
U.S. government.....	4-6
Term of license .....	4-7
Governing law .....	4-7
Assignment.....	4-7
Survival of provisions .....	4-7
Entire agreement .....	4-7
Third party software.....	4-7
Source Code Requests.....	4-7
Compliance with safety standards.....	4-63
Electrical safety compliance .....	4-63
Electromagnetic compatibility (EMC) compliance .....	4-63
Human exposure to radio frequency energy .....	4-63
Compliance with radio regulations .....	4-68
Type approvals .....	4-69
FCC/IC compliance.....	4-70
European Union compliance .....	4-71
<b>Chapter 5: Installation .....</b>	<b>5-1</b>
Safety .....	5-2
Power lines .....	5-2
Working at heights .....	5-2
PSU .....	5-2
Grounding and protective earth.....	5-2
Powering down before servicing.....	5-2
Primary disconnect device .....	5-2
External cables .....	5-3
Drop cable tester.....	5-3
RF exposure near the antenna .....	5-3
Minimum separation distances.....	5-3
Grounding and lightning protection requirements .....	5-3
Grounding cable installation methods .....	5-3
Siting ODUs and antennas.....	5-4
Thermal Safety .....	5-4
Installing the ODU.....	5-5
Attach ground cables to the ODU .....	5-5
Mount the ODU on the mast.....	5-5
Install external antennas for a connectorized ODU .....	5-8
Installing the copper Cat5e Ethernet interface.....	5-9
Install the main drop cable.....	5-9
Test resistance in the drop cable .....	5-11
Installing the PSU .....	5-13

Installing the AC Power Injector .....	5-13
Installing an SFP Ethernet interface .....	5-14
Fitting the long cable gland .....	5-16
Inserting the SFP module .....	5-17
Connecting the cable.....	5-20
Fitting the gland .....	5-21
Removing the cable and SFP module .....	5-22
Supplemental installation information .....	5-23
Stripping drop cable .....	5-23
Creating a drop cable grounding point.....	5-24
Weatherproofing an N type connector .....	5-27
<b>Chapter 6: Configuration and alignment.....</b>	<b>6-1</b>
Preparing for configuration and alignment .....	6-2
Safety precautions.....	6-2
Regulatory compliance.....	6-2
Selecting configuration options.....	6-2
Connecting to the unit .....	6-3
Configuring the management PC .....	6-3
Connecting to the PC and powering up.....	6-4
Using the web interface.....	6-5
Logging into the web interface.....	6-5
Using the installation wizard (Master Mode) .....	6-6
Installation wizard step 1 – Main system parameters .....	6-6
Installation wizard step 2 – Radio parameters.....	6-7
Installation wizard step 3 – Network parameters .....	6-8
Installation wizard step 4 – Security parameters .....	6-9
Using the installation wizard (Slave Mode) .....	6-11
Installation wizard step 1 – Main system parameters .....	6-11
Installation wizard step 2 – Radio parameters.....	6-12
Installation wizard step 3 – Network parameters .....	6-13
Installation wizard step 4 – Security parameters .....	6-14
Using the menu options.....	6-15
Status page .....	6-16
Installation page .....	6-18
Configuration menu .....	6-19
Monitor menu .....	6-37
Tools menu .....	6-50
Other configuration tasks .....	6-59
Connecting to the network .....	6-59
<b>Chapter 7: Operation and Troubleshooting .....</b>	<b>7-60</b>
General Planning for Troubleshooting.....	7-61
General Fault Isolation Process .....	7-61
Questions to Help Isolate the Problem .....	7-62
Upgrading device software .....	7-63
Testing hardware .....	7-64
Checking the power supply LED .....	7-64

Power LED is off.....	7-64
Ethernet LED is off.....	7-64
Troubleshooting the radio link.....	7-67
Module has lost or does not establish radio connectivity .....	7-67
Link is unreliable or does not achieve data rates required .....	7-67
Using the device external reset button .....	7-68
Resetting ODU to factory defaults by power cycling.....	7-69
<b>Glossary.....</b>	<b>LXX</b>



---

# About This User Guide

---

This guide describes the planning, installation, configuration and operation of the Cambium PTP 550 Series of point-to-point wireless Ethernet bridges. It is intended for use by the system designer, system installer and system administrator.

For radio network design, refer to the following chapters:

- [Chapter 1: Product description](#)
- [Chapter 2: System hardware](#)
- [Chapter 3: System planning](#)
- [Chapter 4: Legal and regulatory information](#)

For radio equipment installation, refer to the following chapter:

- [Chapter 5: Installation](#)

For system configuration, monitoring and fault-finding, refer to the following chapter:

- [Chapter 6: Configuration and alignment](#)

## Contacting Cambium Networks

Support website:	<a href="http://www.cambiumnetworks.com/support">http://www.cambiumnetworks.com/support</a>
Main website:	<a href="http://www.cambiumnetworks.com">http://www.cambiumnetworks.com</a>
Sales enquiries:	<a href="mailto:solutions@cambiumnetworks.com">solutions@cambiumnetworks.com</a>
Support enquiries:	<a href="mailto:support@cambiumnetworks.com">support@cambiumnetworks.com</a>
Telephone number list:	<a href="http://www.cambiumnetworks.com/contact">http://www.cambiumnetworks.com/contact</a>
Address:	Cambium Networks Limited, Linhay Business Park, Eastern Road, Ashburton, Devon, UK, TQ13 7UP

## Purpose

Cambium Networks Point-To-Point (PTP) documents are intended to instruct and assist personnel in the operation, installation and maintenance of the Cambium PTP equipment and ancillary devices. It is recommended that all personnel engaged in such activities be properly trained.

Cambium disclaims all liability whatsoever, implied or express, for any risk of damage, loss or reduction in system performance arising directly or indirectly out of the failure of the customer, or anyone acting on the customer's behalf, to abide by the instructions, system parameters, or recommendations made in this document.

## Cross references

References to external publications are shown in italics. Other cross references, emphasized in blue text in electronic versions, are active links to the references.

This document is divided into numbered chapters that are divided into sections. Sections are not numbered, but are individually named at the top of each page, and are listed in the table of contents.

## Feedback

We appreciate feedback from the users of our documents. This includes feedback on the structure, content, accuracy, or completeness of our documents. Send feedback to [support@cambiumnetworks.com](mailto:support@cambiumnetworks.com).

## Important regulatory information

---

The PTP 550 product is certified as an unlicensed device in frequency bands where it is not allowed to cause interference to licensed services (called primary users of the bands).

### USA specific information

---

**Caution**

This device complies with Part 15 of the FCC Rules. Operation is subject to the following two conditions:

- This device may not cause harmful interference, and
  - This device must accept any interference received, including interference that may cause undesired operation.
- 

The USA Federal Communications Commission (FCC) requires manufacturers to implement special features to prevent interference to radar systems that operate in the band 5470 MHz to 5725 MHz. These features must be implemented in all products able to operate outdoors in this band.

Manufacturers must ensure that such radio products cannot be configured to operate outside of FCC rules; specifically it must not be possible to disable or modify the radar protection functions that have been demonstrated to the FCC.

Other variants of the PTP 550 are available for use in the rest of the world, but these variants are not supplied to the USA except under strict controls, when they are needed for export and deployment outside the USA.

### Canada specific information

---

**Caution**

This device complies with Industry Canada's licence-exempt RSSs. Operation is subject to the following two conditions:

- (1) This device may not cause interference; and
  - (2) This device must accept any interference, including interference that may cause undesired operation of the device.
- 

Industry Canada requires manufacturers to implement special features to prevent interference to weather radar systems that operate in the band 5600 MHz to 5650 MHz. These features must be implemented in all products able to operate outdoors in the band 5470 MHz to 5725 MHz.

Manufacturers must ensure that such radio products cannot be configured to operate outside of IC rules; specifically it must not be possible to disable or modify the radar protection functions that have been demonstrated to IC.

In order to comply with these IC requirements, Cambium supplies variants of the PTP 550 for operation in Canada. In particular, operation of radio channels overlapping the band 5600 MHz to 5650 MHz is not allowed and these channels are permanently barred.

In addition, other channels may also need to be barred when operating close to weather radar installations.

Other variants of the PTP 550 are available for use in the rest of the world, but these variants are not supplied to Canada except under strict controls, when they are needed for export and deployment outside Canada.

## Renseignements spécifiques au Canada



### Attention

Le présent appareil est conforme aux CNR d'Industrie Canada applicables aux appareils radio exempts de licence. L'exploitation est autorisée aux deux conditions suivantes :

- (1) l'appareil ne doit pas produire de brouillage, et
- (2) l'utilisateur de l'appareil doit accepter tout brouillage radioélectrique subi, même si le brouillage est susceptible d'en compromettre le fonctionnement.

Industry Canada (IC) a demandé aux fabricants de mettre en œuvre des mécanismes spécifiques pour éviter d'interférer avec des systèmes radar fonctionnant dans la bande 5600 MHz à 5650 MHz. Ces mécanismes doivent être mis en œuvre dans tous les produits capables de fonctionner à l'extérieur dans la bande 5470 MHz à 5725 MHz.

Les fabricants doivent s'assurer que les produits de radiocommunications ne peuvent pas être configurés pour fonctionner en dehors des règles IC, en particulier, il ne doit pas être possible de désactiver ou modifier les fonctions de protection des radars qui ont été démontrés à IC.

Afin de se conformer à ces exigences de IC, Cambium fournit des variantes du PTP 550 exclusivement pour le Canada. Ces variantes ne permettent pas à l'équipement de fonctionner en dehors des règles de IC. En particulier, le fonctionnement des canaux de radio qui chevauchent la bande 5600 MHz à 5650 MHz est interdite et ces canaux sont définitivement exclus.

## EU Declaration of Conformity

Hereby, Cambium Networks declares that the Cambium PTP 550 Series Wireless Ethernet Bridge complies with the essential requirements and other relevant provisions of Directive 1999/5/EC. The declaration of conformity may be consulted at:

<http://www.cambiumnetworks.com/support/ec-doc>

## Application firmware

Download the latest PTP 550 Series firmware and install it in the Outdoor Units (ODUs) before deploying the PTP 550 equipment. Instructions for installing firmware are provided in [Upgrading device software](#) on page 7-63.

## Specific expertise and training for professional installers

To ensure that the PTP 550 is installed and configured in compliance with the requirements of Industry Canada and the FCC, installers must have the radio engineering skills and training described in this section. This is particularly important when installing and configuring a PTP 550 system for operation in the 5.1 GHz and 5.4 GHz UNII bands.

## External antennas

When using a connectorized version of the product (as compared to the version with an integrated antenna), the conducted transmit power may need to be reduced to ensure the regulatory limit on transmitter EIRP is not exceeded. The installer must have an understanding of how to compute the effective antenna gain from the actual antenna gain and the feeder cable losses.

The ranges of permissible values for maximum antenna gain and feeder cable losses are included in this user guide together with a sample calculation. The product GUI automatically applies the correct conducted power limit to ensure that it is not possible for the installation to exceed the EIRP limit, when the appropriate values for antenna gain and feeder cable losses are entered into the GUI.

## Antennas externes

Lorsque vous utilisez une version du produit sans antenne intégrée, il peut être nécessaire de réduire la puissance d'émission pour garantir que la limite réglementaire de puissance isotrope rayonnée équivalente (PIRE) n'est pas dépassée. L'installateur doit avoir une bonne compréhension de la façon de calculer le gain de l'antenne de gain de l'antenne réelle et les pertes dans les câbles de connections.

La plage de valeurs admissibles pour un gain maximal de l'antenne et des pertes de câbles de connections sont inclus dans ce guide d'utilisation avec un exemple de calcul. L'interface utilisateur du produit applique automatiquement la limite de puissance menée correct afin de s'assurer qu'il ne soit pas possible pour l'installation de dépasser la limite PIRE, lorsque les valeurs appropriées pour le gain d'antenne et les pertes de câbles d'alimentation sont entrées dans l'interface utilisateur.

## Ethernet networking skills

The installer must have the ability to configure IP addressing on a PC and to set up and control products using a web browser interface.

## Lightning protection

To protect outdoor radio installations from the impact of lightning strikes, the installer must be familiar with the normal procedures for site selection, bonding and grounding. Installation guidelines for the PTP 550 can be found in [Chapter 2: System hardware](#) and [Chapter 5: Installation](#).

## Training

The installer needs to have basic competence in radio and IP network installation. The specific requirements applicable to the PTP 550 should be gained by reading [Chapter 5: Installation](#) and [Chapter 6: Configuration and alignment](#) and by performing sample set ups at base workshop before live deployments.

# Problems and warranty

---

## Reporting problems

If any problems are encountered when installing or operating this equipment, follow this procedure to investigate and report:

- 1 Search this document and the software release notes of supported releases.
- 2 Visit the support website.
- 3 Ask for assistance from the Cambium product supplier.
- 4 Gather information from affected units, such as any available diagnostic downloads.
- 5 Escalate the problem by emailing or telephoning support.

## Repair and service

If unit failure is suspected, obtain details of the Return Material Authorization (RMA) process from the support website.

## Hardware warranty

Cambium's standard hardware warranty is for one (1) year from date of shipment from Cambium Networks or a Cambium distributor. Cambium Networks warrants that hardware will conform to the relevant published specifications and will be free from material defects in material and workmanship under normal use and service. Cambium shall within this time, at its own option, either repair or replace the defective product within thirty (30) days of receipt of the defective product. Repaired or replaced product will be subject to the original warranty period but not less than thirty (30) days.

To register PTP products or activate warranties, visit the support website. For warranty assistance, contact the reseller or distributor.



### Caution

Using non-Cambium parts for repair could damage the equipment or void warranty. Contact Cambium for service and repair instructions.

Portions of Cambium equipment may be damaged from exposure to electrostatic discharge. Use precautions to prevent damage.

---

## Security advice

---

Cambium Networks systems and equipment provide security parameters that can be configured by the operator based on their particular operating environment. Cambium recommends setting and using these parameters following industry recognized security practices. Security aspects to be considered are protecting the confidentiality, integrity, and availability of information and assets. Assets include the ability to communicate, information about the nature of the communications, and information about the parties involved.

In certain instances Cambium makes specific recommendations regarding security practices, however the implementation of these recommendations and final responsibility for the security of the system lies with the operator of the system.

# Warnings, cautions, and notes

---

The following describes how warnings and cautions are used in this document and in all documents of the Cambium Networks document set.

## Warnings

Warnings precede instructions that contain potentially hazardous situations. Warnings are used to alert the reader to possible hazards that could cause loss of life or physical injury. A warning has the following format:

**Warning**

Warning text and consequence for not following the instructions in the warning.

---

## Cautions

Cautions precede instructions and are used when there is a possibility of damage to systems, software, or individual items of equipment within a system. However, this damage presents no danger to personnel. A caution has the following format:

**Caution**

Caution text and consequence for not following the instructions in the caution.

---

## Notes

A note means that there is a possibility of an undesirable situation or provides additional information to help the reader understand a topic or concept. A note has the following format:

**Note**

Note text.

---



# Caring for the environment

---

The following information describes national or regional requirements for the disposal of Cambium Networks supplied equipment and for the approved disposal of surplus packaging.

## In EU countries

The following information is provided to enable regulatory compliance with the European Union (EU) directives identified and any amendments made to these directives when using Cambium equipment in EU countries.



### Disposal of Cambium equipment

*European Union (EU) Directive 2002/96/EC Waste Electrical and Electronic Equipment (WEEE)*

Do not dispose of Cambium equipment in landfill sites. For disposal instructions, refer to

<http://www.cambiumnetworks.com/support/weee-compliance>

### Disposal of surplus packaging

Do not dispose of surplus packaging in landfill sites. In the EU, it is the individual recipient's responsibility to ensure that packaging materials are collected and recycled according to the requirements of EU environmental law.

## In non-EU countries

In non-EU countries, dispose of Cambium equipment and all surplus packaging in accordance with national and regional regulations.

---

# Chapter 1: Product description

---

This chapter provides a high level description of products in the PTP 550 series. It describes in general terms the function of the product, the main product variants and the main hardware components. The following topics are described in this chapter:

- [Overview of the PTP 550 Series](#) on page 1-2 introduces the key features, typical uses, product variants and components of the PTP 550 series.
- [Wireless operation](#) on page 1-7 describes how the PTP 550 wireless link is operated, including modulation modes, power control and spectrum management.
- [Ethernet bridging](#) on page 1-13 describes how the PTP 550 controls Ethernet data, in both the customer data and system management networks.
- [System management](#) on page 1-15 introduces the PTP 550 management system, including the web interface, installation, configuration, security, alerts and upgrades.

# Overview of the PTP 550 Series

---

This section introduces the key features, typical uses, product variants and components of the PTP 550 series.

## Purpose

Cambium PTP 550 products are designed for Ethernet bridging over point-to-point links in the unlicensed 5 GHz frequency band. Users must ensure that the PTP 550 Series complies with local operating regulations.

The PTP 550 acts as a transparent bridge between two segments of the operator's network. In this sense, it can be treated as a virtual wired connection between two points. The PTP 550 Series forwards 802.3 Ethernet frames destined for the other part of the network and filters frames it does not need to forward. The system is transparent to higher-level protocols such as VLANs.

## Key features

PTP 550 is a rugged high-capacity outdoor point-to-point link wireless device in the unlicensed 5 GHz frequency bands with a maximum UDP throughput of 1.4 Gbps (when operating with 160 MHz maximum aggregate bandwidth). It is capable of operating in line-of-sight (LOS) and near-LOS conditions. Its maximum LOS range is 122 miles (200 km). PTP 550 is available as an integrated unit with a dual-polarized 23 dBi flat-plate antenna, and as a connectorized unit for use with a separate dual-polarized antenna. One point-to-point link consists of two PTP 550 devices.

PTP 550 supports asymmetric dual-channel operation, with channel sizes of 20 MHz, 40 MHz, or 80 MHz in each channel. The maximum aggregate bandwidth is 160 MHz (two 80 MHz channels). Each channel supports 2 x 2 MIMO operation with polarization multiplexing or polarization diversity, resulting in a form of 4 x 4 MIMO. Dual-channel operation use non-contiguous channels, and the channels can be in the same regulatory band or different regulatory bands. Channel bandwidth can be selected independently in the two channels and adaptive modulation also acts independently.

PTP 550 is based on highly-integrated wireless semiconductor components designed to meet the IEEE 802.11ac standard, however the PTP 550 device has a proprietary air interface for the main point-to-point link.

PTP 550 is powered by standard power-over-Ethernet to a 1000Base-T port. The unit additionally has an SFP port for optional addition of a fiber or copper SFP module.

Management of the unit is conducted via the same interface as the bridged traffic (in-band Management).

A summary of the main PTP 550 characteristics is listed under [Table 1](#).



**Table 1** Main characteristics of the PTP 550 Series

Characteristic	Value
Topology	PTP
Wireless link condition	LOS, near LOS
Scheduler	TDD
Connectivity	Ethernet
Operating frequencies	Unlicensed bands, 5 GHz
Channel bandwidth	20 MHz, 40 MHz, 80 MHz (independent per channel)
Data rate	1.4 Gbps

## Frequency bands

The PTP 550 ODU can be configured by the user to operate in the following bands:

- 5.1 GHz band: 5170 to 5250 MHz
- 5.2 GHz band: 5250 to 5320 MHz
- 5.4 GHz band: 5520 to 5725 MHz
- 5.8 GHz band: 5725 to 5980 MHz

## Typical bridge deployment

The PTP 550 is an “all outdoor” solution consisting of a wireless bridge between two sites. Each site installation consists of a PTP 550 Integrated or PTP 550 Connectorized outdoor unit (ODU) and a power injector (PSU) (Figure 1). The ODU provides the following interfaces:

- PSU port: This provides proprietary power over Ethernet and connection to the management and/or data networks via 100BASE-TX or 1000BASE-T Ethernet. In the basic configuration, this is the only Ethernet connection to the ODU.
- SFP port: This provides an optical or copper Gigabit Ethernet interface for customer data and/or network management.

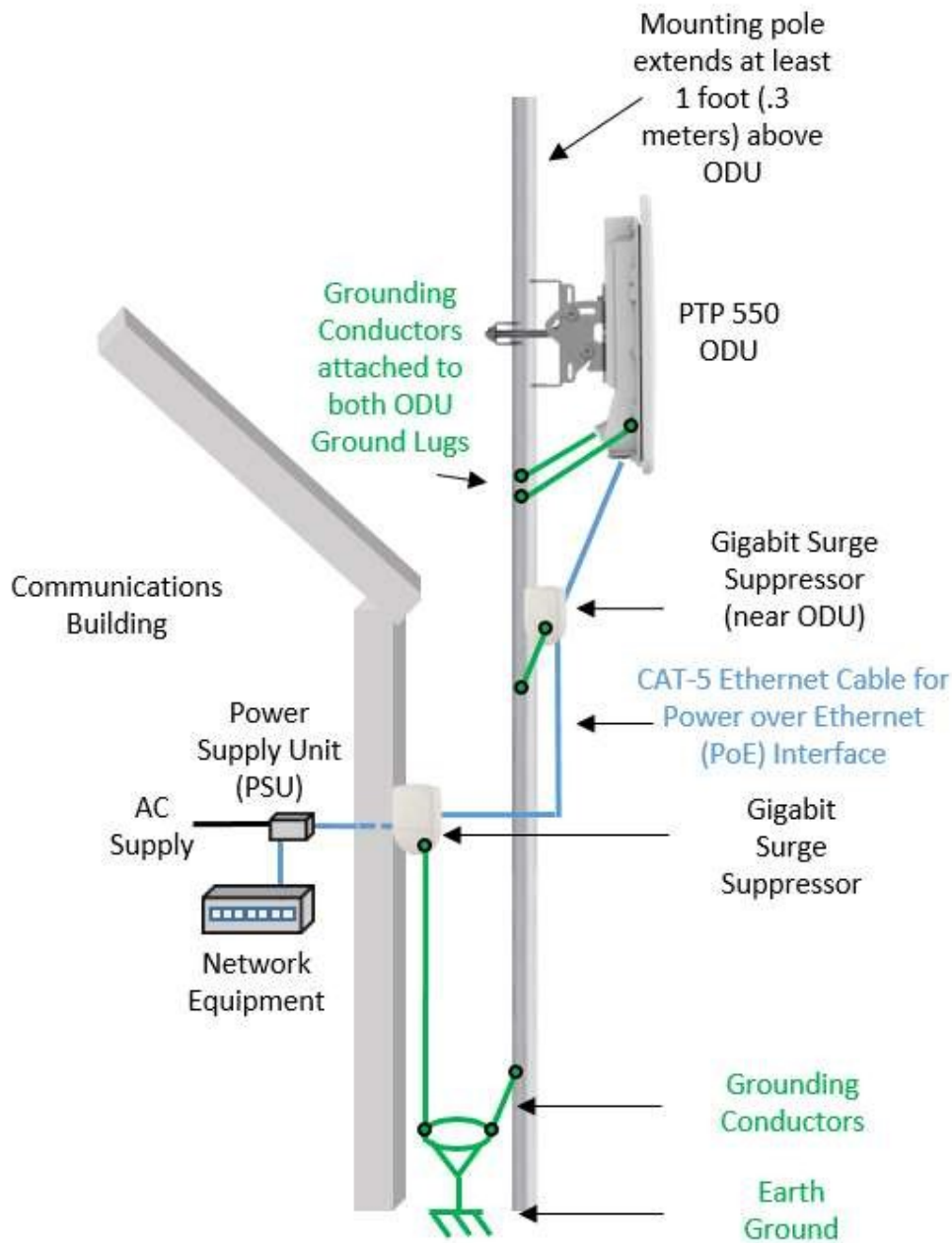
**Figure 1** PTP 550 typical bridge deployment

## Hardware overview

The main hardware components of the PTP 550 are as follows:

- Outdoor unit (ODU): The ODU is a self-contained transceiver unit that houses both radio and networking electronics. The PTP 550 ODU is supplied in two configurations:
  - A PTP 550 Integrated ODU attached to a 23 dBi flat plate antenna
  - A PTP 550 Connectorized ODU intended to work with separately mounted external antennas.

- The ODU is supplied in the following regional variants:
  - FCC, intended for deployment in the USA
  - IC, intended for deployment in Canada
  - EU, intended for deployment in countries of the European Union or other countries following ETSI regulations
  - Rest of the World (RoW), intended for deployment in countries other than USA, Canada, and EU countries.
- Power supply unit (PSU)
- Antennas and antenna cabling: Connectorized ODUs require external antennas connected using RF cable.
- Ethernet cabling: All configurations require a copper Ethernet Cat5e connection from the ODU (PSU port) to the PSU. Advanced configurations may also require a copper or optical SFP connection from the ODU (SFP port) to network terminating equipment or another device.
- Gigabit Surge Suppressor: Surge suppressors are installed in the PSU copper drop cables to provide transient voltage surge suppression.
- Ground cables: ODU and outdoor copper Ethernet cables are bonded to the site grounding system using ground cables.

For more information about these components, including interfaces, specifications and Cambium part numbers, refer to [Chapter 2: System hardware](#).

# Wireless operation

This section describes how the PTP 550 wireless link is operated, including modulation modes, power control and security.

## Channel Bonding

PTP 550 features three radio interfaces – two radios are used for data transfer and one radio is used for a real time spectrum analyzer and Dynamic Channel Selection (supported in a future release).

The data transfer radios operate:

- In the 5 GHz band
- On separate, non-overlapping channels
- With the same or different channel bandwidths. For example, one radio may operate with a 20 MHz channel size and one radio may operate with an 80 MHz channel size.

The PTP 550 device automatically “bonds” the data traffic on the two radio interfaces to support high data transfer rates.

## Channel Bonding Use Cases

Channel bonding results in higher throughput rates and introduces opportunities for customizing the PTP link to meet deployment requirements.

The following table provides examples of how the PTP 550 channel bonding may be utilized to maximize network performance and resilience:

**Table 2** Channel Bonding Use Case Examples

Channel 1	Channel 2	Scenario	Supported Throughput
80	80	Two full clean channels	1.4 Gbps
40	80	Two clean channels	1.03 Gbps
40	40	Two clean channels	650 Mbps
80	20	One clean channel, one noisy channel	840 Mbps
20	40	One clean channel, one noisy channel	465 Mbps
20	20	Limited spectrum, Noisy environment	280 Mbps

## Time division duplexing

### TDD cycle

PTP 550 links operate using Time Division Duplexing (TDD). They use a TDD cycle in which the ODUs alternately transmit and receive TDD bursts. The TDD cycle is illustrated in [Figure 2](#). The steps in the cycle are as follows:

- 1 The TDD master transmits a burst to the TDD slave.



- 2 A delay occurs as the master-slave burst propagates over the link.
- 3 The slave receives the burst from the master.
- 4 The slave processes the master-slave burst.
- 5 The slave transmits a burst to the master.
- 6 A delay occurs as the slave-master burst propagates over the link.
- 7 The master receives the burst from the slave.
- 8 The master transmits the next burst to the slave.

The frame duration must be long enough to allow the master to receive the complete burst in 7 before starting to transmit in 8.

**Figure 2** TDD cycle – single channel

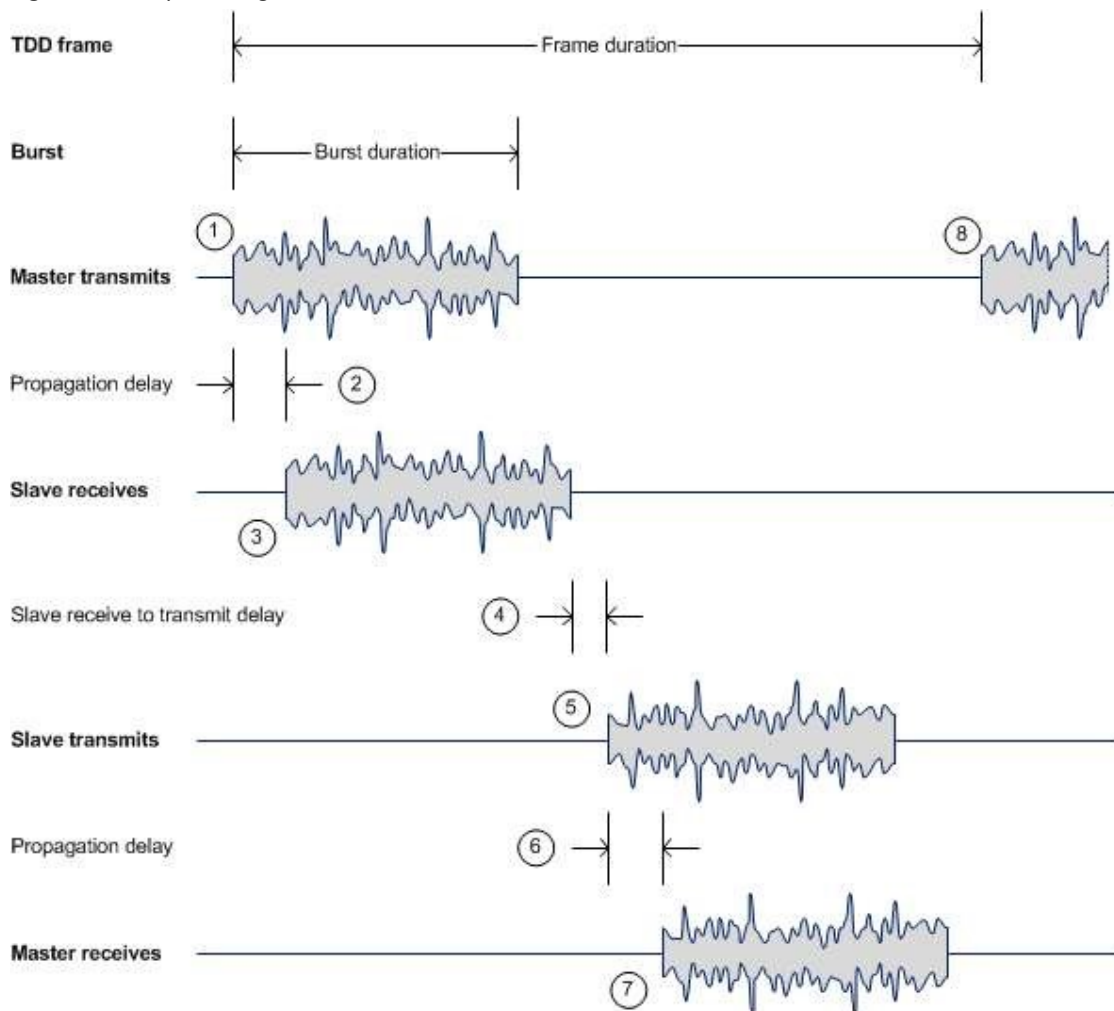

## Link Scheduler

The PTP 550 series provides three configuration options for apportioning the available capacity between the two link directions.

- **75/25** – The capacity in the direction Master to Slave comprises 75% of available TDD frame, and the capacity in the direction of Slave to Master comprises 25% of available TDD frame.
- **50/50** (Symmetric) - The capacity in the direction Master to Slave comprises 50% of available TDD frame, and the capacity in the direction of Slave to Master comprises 50% of available TDD frame.
- **30/70** – The capacity in the direction Master to Slave comprises 30% of available TDD frame, and the capacity in the direction of Slave to Master comprises 70% of available TDD frame.

## OFDM and channel bandwidth

The PTP 550 transmits in two channels using Orthogonal Frequency Division Multiplexing (OFDM). This wideband signal consists of many equally spaced sub-carriers. Although each sub carrier is modulated at a low data rate using conventional modulation schemes, the resultant data rate from all the sub-carriers is high.

The channel bandwidth of the OFDM signal is 20 MHz, 40 MHz or 80 MHz, based on operator configuration.

Each channel is offset in center frequency from its neighboring channel by 5 MHz. PTP 550 supports 5 MHz channel separation / guard band between the two radio interfaces (5MHz separation between the two operating band edges). PTP 550 does not allow operation with two overlapping channels.



### Note

The Channel Bandwidth must be configured to the same value at both ends of the link for each channel. Not all channel bandwidths are available in all regulatory bands.

## Further reading

For information about...	Refer to...
Channel bandwidths per frequency band	<a href="#">General wireless specifications</a> on page 3-26
How to plan for channel bandwidth	<a href="#">Channel bandwidth</a> on page 3-28

## Adaptive modulation

The PTP 550 can transport data over the wireless link using a number of different modulation modes ranging from 256-QAM to QPSK (selected independently between the two channels of operation). For a given channel bandwidth and TDD frame structure, each modulation mode transports data at a fixed rate. Also, the receiver requires a given signal to noise ratio in order to successfully demodulate a given modulation mode. Although the more complex modulations such as 256-QAM will transport data at a much higher rate than the less complex modulation modes, the receiver requires a much higher signal to noise ratio.

The PTP 550 provides an adaptive modulation scheme (on each channel in dual-channel operation) where the receiver constantly monitors the quality of the received signal and notifies the sender of the success of received packets such that the sender can select the optimum modulation mode with which to transmit. In this way, optimum capacity is achieved at all times.

**Note**

LINKPlanner includes an estimate of mean data rate, the data rate provided by each modulation and the percentage of time spent in each modulation mode.

Planning for adaptive modulation

[Adaptive modulation](#) on page 3-30

System threshold

[System threshold](#) on page 3-36

## MIMO

Multiple-Input Multiple-Output (MIMO) techniques provide protection against fading and increase the probability that the receiver will decode a usable signal. When the effects of MIMO are combined with those of OFDM techniques and a high link budget, there is a high probability of a robust connection over a non-line-of-sight path.

For each independent radio the PTP 550 transmits two signals on the same radio frequency, one of which is vertically polarized and the other horizontally polarized. Depending on the channel conditions, the PTP 550 will adapt between two modes of operation:

- **Dual Payload:** When the radio channel conditions allow, the PTP 550 will transmit two different and parallel data streams, one on the vertical channel and one on the horizontal channel. This doubles the capacity of the PTP 550.
- **Single Payload:** As the radio channel becomes more challenging, the PTP 550 has the ability to detect this and switch to a mode which transmits the same data stream on both vertical and horizontal channels. This provides polarity diversity and is another key feature which allows the PTP 550 to operate in challenging non- line of sight radio channels.

**Note**

The system automatically chooses between dual and single payload to try to increase the capacity of a link.

## Further reading

For information about...

Refer to...

Single and dual payload modulation modes

[System threshold](#) on page 3-36

## DFS Tuning

This release now supports superior DFS detection, capable of minimizing DFS false detection than earlier.

## Encryption

The PTP 550 supports optional encryption for data transmitted over the wireless link. The encryption algorithm used is the Advanced Encryption Standard (AES) with 128-bit key size. AES is a symmetric encryption algorithm approved by U.S. Government organizations (and others) to protect sensitive information.

### Further reading

For information about...	Refer to...
AES requirement for HTTPS/TLS	<a href="#">Transport layer security on page 1-17</a>

## Regulatory bands

The PTP 550 provides the ability to choose the country of operation for the ODU, and lists the regulatory bands that are licensed by regulators in that country. Please note that some SKUs limit countries of selection. FCC limits country selection to United States and IC limits country selection to Canada. If a country provides access to more than one regulatory band, PTP 550 provides a choice between the available bands. In each regulatory band, PTP 550 sets the following aspects of wireless operation to comply with the applicable regulations (based on regional variant and configuration of the **Country** parameter):

- Maximum transmit power
- Radar avoidance
- Transmit power reduction in edge channels
- Frequency range
- Channel plan

## Dual-channel Conducted Transmit Power Constraints

The conducted transmission power of each PTP 550 radio complies with the following constraints:

- If both radios are configured in the same sub-band then the maximum transmit power of both radios is adjusted down to reduce interference and ensure compliance with applicable EIRP regulations:
  - For sub-bands 5.1, 5.2, 5.3, and 5.4 GHz the maximum configurable transmit power of each radio is reduced by 3 dBm
  - For sub-band 5.8 GHz, the maximum configurable transmit power of each radio is reduced by 6 dBm
- If the configured channel on either radio spans two neighboring sub-bands, then the maximum configurable transmit power of each radio complies to the most conservative sub-band.
- If the two radios are configured in non-neighboring sub-bands, then the maximum configurable transmit power on one or both radios may be reduced to reduce interference.

**Caution**

To avoid possible enforcement action by the country regulator, always operate links in accordance with local regulations.

**Attention**

Pour éviter une éventuelle sanction par le régulateur du pays, utiliser toujours nos liaisons radiofréquences conformément à la réglementation locale.

## Further reading

For information about...	Refer to...
Planning PTP 550 links to conform to the regulatory band restrictions	<a href="#">Radio spectrum planning</a> on page 3-26
Radio regulations in the country of operation	<a href="#">Compliance with radio regulations</a> on page 4-68

## PTP networks

### Using frequency planning

Frequency planning is the exercise of assigning operating channels to PTP units so as to minimize RF interference between links. Frequency planning must consider interference from any PTP unit to any other PTP unit in the network as well as any other RF device located near the PTP link. Low levels of interference normally allow for stable operation and high link capacity.

The frequency planning task is made more straightforward by use of the following techniques:

- Using several different channels
- Separating units located on the same mast
- Using high performance (directional) external antennas

# Ethernet bridging

---

This section describes how the PTP 550 processes Ethernet data.

## Ethernet ports

The PTP 550 Series ODU has two Ethernet ports:

- **Main PSU:** The Main PSU port provides a copper Ethernet interface for 100BASE-TX and 1000BASE-T, and accepts power from the AC Power Injector to the ODU (802.3at).
- **SFP:** The SFP port is a small format pluggable receptacle accepting copper or optical plug-in modules supplied as part of the SFP module kit.

## Data network

### Transparent Ethernet service

The PTP 550 Series provides an Ethernet service between one of the Ethernet ports at a local ODU and one of the Ethernet ports at an associated remote ODU.

The service is transparent to untagged frames, standard VLAN frames, priority-tagged frames, provider bridged frames, and provider backbone bridged frames. In each case, the service preserves MAC addresses, VLAN ID, Ethernet priority and Ethernet payload in the forwarded frame. The maximum frame size for bridged frames in the customer network is 1538 bytes.

### Layer two control protocols

The Data Service in the PTP 550 Series is transparent to layer two control protocols (L2CP) including:

- Spanning tree protocol (STP), rapid spanning tree protocol (RSTP)
- Multiple spanning tree protocol (MSTP)
- Link aggregation control protocol (LACP)
- Link OAM, IEEE 802.3ah
- Port authentication, IEEE 802.1X
- Ethernet local management interface (E-LMI), ITU-T Q.933.
- Link layer discovery protocol (LLDP)
- Multiple registration protocol (MRP)
- Generic attribute registration protocol (GARP)

The PTP 550 Series does not generate or respond to any L2CP traffic.

## Protocol model

Ethernet bridging behavior at each end of the wireless link is equivalent to a two-port, managed, transparent MAC bridge.

Frames are transmitted at the Wireless port over a proprietary point-to-point circuit-mode link layer between ends of the PTP 550 link.

Ethernet frames received at the Ethernet ports, or generated internally within the management agent, are encapsulated within a lightweight MAC layer for transmission over the wireless link.

## Quality of Service (QoS)

PTP 550 provides three priority types for traffic waiting for transmission over the wireless link – Voice, High and Low. Low is the lowest priority and Voice is the highest priority. Traffic is scheduled using strict priority; in other words, traffic in a given priority is transmitted when all higher-priority transmissions are complete.

# System management

---

This section introduces the PTP 550 management system, including the web interface, installation, configuration, alerts and upgrades.

## Management agent

PTP 550 equipment is managed through an embedded management agent. Management workstations, network management systems or PCs can be connected to this agent using an in-band network management mode. These modes are described in detail in [Network management](#) on page 1-16.

The management agent includes a dual IPv4/IPv6 interface at the management agent. The IP interface operates in the following modes:

- IPv4 only (default)
- IPv6 only
- Dual IPv4/IPv6

In the dual IPv4/IPv6 mode, the IP interface is configured with an IPv4 address and an IPv6 address and can operate using both IP versions concurrently. This dual mode of operation is useful when a network is evolving from IPv4 to IPv6.

The management agent supports the following application layer protocols (regardless of the management agent IP mode):

- Hypertext transfer protocol (HTTP)
- HTTP over transport layer security (HTTPS/TLS) TELNET
- Simple network management protocol (SNMP)
- Network time protocol (NTP)
- System logging (syslog)



## Network management

### IPv4 and IPv6 interfaces

The PTP 550 ODU contains an embedded management agent with IPv4 and IPv6 interfaces. Network management communication is exclusively based on IP and associated higher layer transport and application protocols. The default IPv4 address of the management agent is 169.254.1.1. There is no default IPv6 address. The PTP 550 does not require use of supplementary serial interfaces.

### MAC address

The management agent end-station MAC address is recorded on the enclosure and is displayed on the Status web page. The MAC address is not configurable by the user.

### Management VLAN

The device management interface can be assigned to a Management VLAN to separate management traffic (device management via SNMP or HTTP) from user traffic.

### Access to the management agent

The management agent can be reached from any Ethernet port at the local ODU.

Management frames are processed by the management agent if (a) the destination MAC address in the frame matches the ODU MAC address, and (b) the VLAN ID in the frame matches the VLAN configuration of the management agent.

### MAC address and IP address of the management agent

The management agent does not provide the function of a dual-homed or multi-homed host. Network designers should take care to ensure that the ODU will not be connected to more than one IP network.

### Web server

The PTP 550 management agent contains a web server. The web server supports the HTTP and HTTPS/TLS interfaces.

Web-based management offers a convenient way to manage the PTP 550 equipment from a locally connected computer or from a network management workstation connected through a management network, without requiring any special management software. The web-based interfaces are the only interfaces supported for installation of PTP 550.

### Web pages

The web-based management interfaces provide comprehensive web-based fault, configuration, performance and security management functions organized into the following web-pages and groups:

- **Status:** The Status web-page reports the detailed status of the PTP 550.
- **Installation:** The Installation web-page is used to monitor installation-specific configuration and status parameters.
- **Configuration:** These web-pages are used to configure the radio, system, network, and security parameters.

- **Monitor:** The Monitor web-page provides detailed reports of system performance and configured parameters, a throughput chart, and a system log.
- **Tools:** The tools webpage includes software to aid in software upgrade, backup/restore, spectrum analysis, alignment, link testing, and networking testing.

## Transport layer security

The HTTPS/TLS interface provides the same set of web-pages as the HTTP interface, but allows HTTP traffic to be encrypted using Transport Layer Security (TLS). PTP 550 uses AES encryption for HTTPS/TLS.

## Identity-based user accounts

The PTP 550 web-based interface provides the following method of authenticating users:

- Role-based user authentication allows the user, on entry of a valid password, to access all configuration capabilities and controls.

## Further reading

For information about...	Refer to...
How to log in and use the menu	<a href="#">Using the web interface</a> on page 6-5
Planning the security material needed for HTTPS/TLS.	<a href="#">Security planning</a> on page 3-35
How to configure user accounts	<a href="#">Configuration &gt; System page</a> on page 6-24

## SNMP

The management agent supports fault and performance management by means of an SNMP interface. The management agent is compatible with SNMP v2c using one Management Information Base (MIB) file which is available for download from the Cambium Networks Support website <http://>

## Further reading

For information about...	Refer to...
How to configure SNMPv2c	<a href="#">Configuration &gt; System page</a> on page 6-24

## Network Time Protocol (NTP)

The clock supplies accurate date and time information to the system. It can be set to run with or without a connection to a network time server (NTP). It can be configured to display local time by setting the time zone on the System web page.

## Further reading

For information about...	Refer to...
How to plan for NTP operation	<a href="#">Planning for NTP operation</a> on page 3-35
How to configure NTP	<a href="#">Configuration &gt; System page</a> on page 6-24

## Trial Config

This release provides users the option to make configuration changes and observe the effects before applying the changes. The trail configuration period is set to 5 minutes and cannot be changed.

## System logging (syslog)

PTP 550 supports the standard syslog protocol to log important configuration changes, status changes and events.

PTP 550 creates syslog messages for configuration changes to any attribute that is accessible via the web-based interface, or via the enterprise MIB at the SNMP interface.

PTP 550 additionally creates syslog messages for changes in any status variable displayed in the web-based interface.

PTP 550 creates syslog messages on a number of events (for example successful and unsuccessful attempts to log in to the web-based interface).

PTP 550 can be configured to send syslog messages to up to four standard syslog servers.

Additionally, PTP 550 logs event notification messages locally. Locally-stored event messages survive reboot of the unit, and are overwritten only when the storage capacity is exhausted. The locally stored events can be reviewed using the web-based user interface.

### Further reading

For information about...	Refer to...
Configuring system logging	<a href="#">Configuration &gt; System page</a> on page 6-24

## Software upgrade

The management agent supports application software upgrade using either the web-based interface, the SNMP interface, or cnMaestro management software.

PTP 550 software images are digitally signed, and the ODU will accept only images that contain a valid Cambium Networks digital signature. The ODU always requires a reboot to complete a software upgrade.



#### Note

Obtain the application software and this user guide from the support website BEFORE warranty expires.



#### Caution

ODU software version must be the same at both ends of the link. Limited operation may sometimes be possible with dissimilar software versions, but such operation is not supported by Cambium Networks.



#### Caution

Take care when upgrading ODU software using the wireless link to a remote ODU. Upgrade the remote unit first, reboot the remote ODU, and then upgrade the local unit to the same software version.

## Further reading

For information about...	Refer to...
How to upgrade the software using the web interface	<a href="#">Tools &gt; Software Upgrade page</a> on page 6-50.

## cnMaestro Zero-Touch

With Release 4.4.1 on ePMP, it has never been easier to get a subscriber module configured on your network. Using this feature, SMs can be automatically onboarded to cnMaestro Monitoring and Management System and then upgraded and configured through.

cnMaestro URL can be configured manually or obtained from DHCP Server both on APs and SMs. DHCP options 43, 15, 52, 17 can be used for cnMaestro URL configuration via DHCP. SMs can use URL configured on AP they are connected to as well. Otherwise APs and SMs automatically are trying to connect to default cnMaestro Cloud URL.

Zero-Touch feature is enabled by default and is available for configuration on AP.

The screenshot shows the cnMaestro configuration page with the following settings:

- Remote Management:** Disabled (radio button selected)
- Zero Touch:** Enabled (radio button selected)
- cnMaestro URL:** [Empty text input field]
- Cambium ID:** [Empty text input field]
- Onboarding Key:** [Masked text input field with 7 asterisks and a toggle icon]

---

## Chapter 2: System hardware

---

This chapter describes the hardware components of a PTP 550 link.

The following topics are described in this chapter:

- [Outdoor unit \(ODU\)](#) on page 2-2
- [Power supply units \(PSU\)](#) on page 2-9
- [Antennas and antenna cabling](#) on page 2-12
- [Ethernet cabling](#) on page 2-13

# Outdoor unit (ODU)

---

## ODU description

One ODU is required for each link end. The ODU is a self-contained transceiver unit that houses both radio and networking electronics.

## Hardware platform variants

PTP 550 ODUs are available in two different hardware platform variants:

- PTP 550 Integrated ODU
- PTP 550 Connectorized ODU

## Regional variants

Each of the PTP 550 hardware platform variants is available in four different regional variants:

- FCC (USA)
- IC (Canada)
- RoW (non FCC/IC/EU countries)
- EU (European Union)



## PTP 550 Integrated ODU

The PTP 550 Integrated ODU is attached to a 23 dBi flat plate antenna (Figure 3) and is intended for medium to long-range difficult links and traditional backhaul requirements where high capacity and high link budget are required.

**Figure 3** PTP 550 Integrated ODU (front and rear views)



## Integrated ODU kit part numbers

Order PTP 550 Integrated ODU kits from Cambium Networks ([Table 3](#)).

Each of the parts listed in [Table 3](#) includes the following items:

- One 23 dBi integrated ODU
- One PSU of the type stated in the Cambium description.
- Mounting bracket
- One line cord (excluding C050055H012A), either US (FCC), IC (ISED Canada) or EU (EU and RoW).

**Table 3** ODU kit part numbers for Integrated ODUs

Cambium description	Cambium part number
PTP 550 Integrated 5 GHz (FCC) with US Line Cord	C050055H007A
PTP 550 Integrated 5 GHz (IC) with US Line Cord	C050055H008A
PTP 550 Integrated 5 GHz (EU) with EU Line Cord	C050055H009A
PTP 550 Integrated 5 GHz (ROW) with US Line Cord	C050055H010A
PTP 550 Integrated 5 GHz (ROW) with EU Line Cord	C050055H011A
PTP 550 Integrated 5 GHz (ROW) with No Line Cord	C050055H012A

## PTP 550 Connectorized ODU

The PTP 550 Connectorized ODU is intended to work with separately mounted external antennas ([Figure 4](#)) in long-range difficult links and traditional backhaul requirements where high capacity and high link budget are required. External antennas generally have higher gains than the integrated antennas, allowing the PTP 550 to cope with more difficult radio conditions.



**Figure 4** PTP 550 Connectorized ODU (front and rear views)**Note**

To determine when to install connectorized units and to calculate their impact on link performance and regulatory limits, see [Planning for connectorized units](#) on page 3-31.

To select antennas, RF cables and connectors for connectorized units, see [Antennas and antenna cabling](#) on page 2-12.

**Attention**

Pour déterminer si il est nécessaire d'installer une liaison radiofréquence avec des antennes externes et pour calculer leur impact sur les performances de la liaison et les limites réglementaires, voir [Planning for connectorized units](#) page 3-31.

Pour sélectionner les antennes, câbles et connecteurs RF pour les liaisons radiofréquence sans antenne intégrée, voir [Antennas and antenna cabling](#) page 2-12.

## Connectorized ODU kit part numbers

Order PTP 550 Connectorized ODU kits from Cambium Networks ([Table 4](#)).

Each of the parts listed in [Table 4](#) includes the following items:

- One Connectorized ODU
- One ODU mounting bracket
- One PSU of the type stated in the Cambium description.

- One line cord (excluding C050055H006A) , either US (FCC), Canada (IC), or EU (EU and RoW).

**Table 4** ODU kit part numbers for Connectorized ODUs

Cambium description	Cambium part number
PTP 550 Connectorized 5 GHz (FCC) with US Line Cord	C050055H001A
PTP 550 Connectorized 5 GHz (IC) with US Line Cord	C050055H002A
PTP 550 Connectorized 5 GHz (EU) with EU Line Cord	C050055H003A
PTP 550 Connectorized 5 GHz (ROW) with US Line Cord	C050055H004A
PTP 550 Connectorized 5 GHz (ROW) with EU Line Cord	C050055H005A
PTP 550 Connectorized 5 GHz (ROW) with No Line Cord	C050055H006A

## ODU accessories

Spare ODU port blanking plugs are available from Cambium Networks ([Table 5](#)).

**Table 5** ODU accessory part numbers

Cambium description	Cambium part number
Blanking Plug Pack (Qty 10)	N000065L036

## Mounting bracket

PTP 550 supports below mentioned mounting bracket option:

**Table 6** PTP 550 ODU mounting bracket part numbers

Bracket	Pole diameter	ODU variants	Bracket part number
Low profile bracket	40 mm to 82 mm (1.6 inches to 3.2 inches)	PTP 550 Integrated PTP 550 Connectorized	N000045L002A

The low profile bracket provides elevation adjustment of +10° to -5° or +5° to -10°.

If separate ODU mounting brackets are required, order them from Cambium Networks.

**Figure 5** ODU low profile bracket

## ODU interfaces

The PSU and SFP ports are on the rear of the integrated and connectorized ODUs ([Figure 6](#)). These interfaces are described in [Table 7](#).

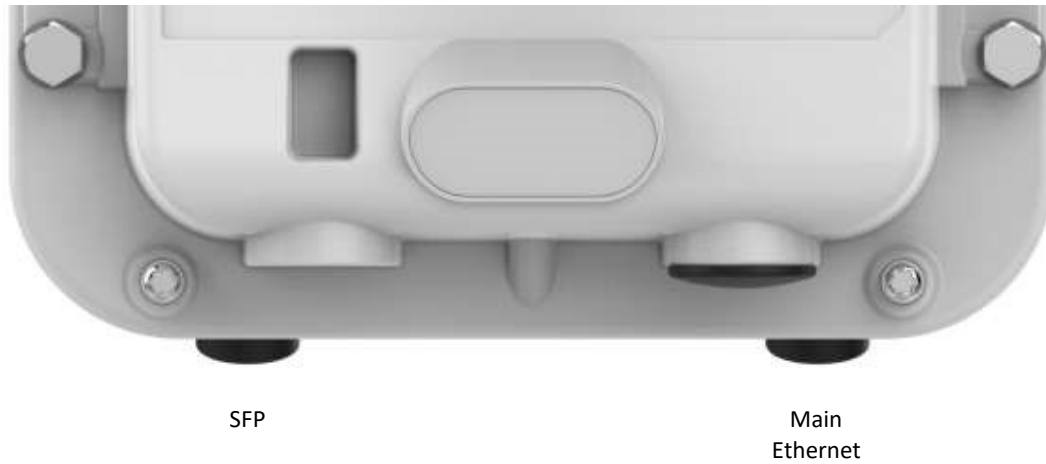
**Figure 6** ODU rear interfaces**Table 7** ODU rear interfaces

Port name	Connector	Interface	Description
Main Ethernet	RJ45	POE input	802.3at Power over Ethernet (POE).
		100/1000BASE-T Ethernet	Management and/or data.
SFP	SFP	Optical or Copper Gigabit Ethernet	Management and/or data.

The front of the connectorized ODU ([Figure 7](#)) provides N type female connectors for RF cable interfaces to antennas with horizontal (H) and vertical (V) polarization.

**Figure 7** Connectorized ODU antenna interfaces



## ODU specifications

The PTP 550 ODU conforms to the specifications listed in [Table 8](#).

**Table 8** ODU specifications

Category	Specification
Dimensions	23 dBi integrated: 305 mm (12.0 in) x 305 mm (12.0 in) x 68 mm (2.2 in) Connectorized: 278 mm (11.0 in) x 185 mm (7 in) x 88 mm (3.5 in)
Weight	23 dBi integrated: 2.2 Kg (4.85 lbs) including bracket Connectorized: 1.6 Kg (3.5 lbs) including bracket
Temperature	-40°C (-40°F) to +60°C (140°F), including solar radiation
Wind loading	200 mph (323 kph) maximum. See <a href="#">ODU wind loading</a> on page 3-24.
Humidity	100% condensing
Liquid and particle ingress	IP66, IP67
Static discharge	See <a href="#">Electromagnetic compatibility (EMC) compliance</a> on page 4-63

# Power supply units (PSU)

---

## PSU description

The PSU is an indoor unit that is connected to the ODU and network terminating equipment using Cat5e cable with RJ45 connectors. It is also plugged into an AC power supply so that it can inject Power over Ethernet (POE) into the ODU.

**Figure 8** PTP 550 PSU



### Warning

Always use an appropriately rated and approved AC supply cord-set in accordance with the regulations of the country of use.



### Caution

The PSU ODU ports are designed to connect only to PTP 550 ODUs. Do not connect any other equipment, as damage may occur.

Do not connect the PIDU Plus PTP 300/500/600 Series to the PTP 550 ODU.



### Note

Each of the ODU kits listed in [Table 3](#) and [Table 4](#) includes one PSU and one US or EU line cord as stated in the Cambium description.

---

## PSU part numbers

Order PSUs and (for AC power) line cords from Cambium Networks ([Table 9](#)).

**Table 9** Power supply component part numbers

Cambium description	Cambium part number
PTP 550 AC Power Injector	N000000L034A
CABLE, UL POWER SUPPLY CORD SET, 720mm, US	N000900L031A
CABLE, UL POWER SUPPLY CORD SET, 720mm, EU	N000900L032A

## AC Power Injector interfaces

The AC Power Injector interfaces are shown in [Figure 9](#) and described in [Table 10](#).

**Figure 9** AC Power Injector interfaces



**Table 10** AC Power Injector interface functions

Interface	Function
AC power in	AC power input (main supply).
ODU	RJ45 socket for connecting Cat5e cable to ODU.
LAN	RJ45 socket for connecting Cat5e cable to network.
Power (green) LED	Power supply detection

## PSU specifications

The PTP 550 AC Power Injector conforms to the specifications listed in [Table 12](#).

**Table 11** AC Power Injector specifications

Category	Specification
Dimensions	137 mm (5.4 in) x 56 mm (2.2 in) x 38 mm (1.5 in)

Weight	0.240 Kg (0.5 lbs)
Temperature	0°C to +40°C
Humidity	90% non-condensing
Waterproofing	Not waterproof
Altitude	Sea level to 5000 meters (16000 ft)
AC Input	Min 90 V AC, 57 – 63 Hz, max 264 V AC, 47 – 53 Hz.
DC output voltage to the ODU	55V +/- 5%
AC connector	IEC-320-C8
Efficiency	Better than 85%, efficiency level 'V'
Over Current Protection	Hiccup current limiting, trip point set between 120% to 150% of full load current
Hold up time	At least 10 milliseconds



# Antennas and antenna cabling

## Antenna requirements

Each connectorized ODU requires one external antenna (normally dual-polar). These antennas are not supplied by Cambium Networks.



### Note

To determine when to install connectorized units and to calculate their impact on link performance and regulatory limits, see [Planning for connectorized units](#) on page 3-31.

## RF cable and connectors

RF cable of generic type LMR-400 is required for connecting the ODU to the antenna. N type male connectors are required for connecting the RF cables to the connectorized ODU. Two connectors are required per ODU. Use weatherproof connectors, preferably ones that are supplied with adhesive lined heat shrink sleeves that are fitted over the interface between the cable and connector. Order CNT-400 RF cable and N type male connectors from Cambium Networks ([Table 14](#)).

**Table 12** RF cable and connector part numbers

Cambium description	Cambium part number
50 Ohm Braided Coaxial Cable - 75 meter	30010194001
50 Ohm Braided Coaxial Cable - 500 meter	30010195001
RF Connector, N, Male, Straight for CNT-400 Cable	09010091001



### Note

To select the correct connectors for the antenna end of the RF cable, refer to the antenna manufacturer's instructions.

## Antenna accessories

Connectorized ODUs require the following additional components:

- Self-amalgamating and PVC tape: Order these items to weatherproof the RF connectors.
- Lightning arrestors: When the connectorized ODU is mounted indoors, lightning arrestors are required for protecting the antenna RF cables at building entry. One arrestor is required per antenna cable. One example of a compatible lightning arrestor is the Polyphaser LSXL-ME or LSXL (not supplied by Cambium Networks).

# Ethernet cabling

---

## Ethernet standards and cable lengths

All configurations require a copper Ethernet connection from the ODU (PSU port) to the PSU. Advanced configurations may also require one the following:

- An optical or copper Ethernet connection from the ODU (SFP port) to network terminating equipment or a linked ODU.

[Table 13](#) specifies, for each type of PSU and power supply, the maximum permitted PSU drop cable length.

[Table 14](#) specifies, for copper SFP interfaces, the Ethernet standards supported and the maximum permitted drop cable lengths.



### Note

For optical SFP interfaces, refer to [SFP module kits](#) on page 2-17 for details of the Ethernet standards supported and maximum permitted cable lengths.

**Table 13** PSU drop cable length restrictions

Type of PSU installed	Power supply to PSU	Ethernet supported (*1)	Power output to auxiliary device	Maximum cable length (*2)
AC Power Injector	AC mains	100BASE-TX 1000BASE-T	No	100 m (330 ft)

(\*1) 10BASE-T is not supported by PTP 550.

(\*2) Maximum length of Ethernet cable from ODU to network terminating equipment via PSU.

(\*3) Ethernet is provided via optical SFP interface.

**Table 14** Copper SFP Ethernet standards and cable length restrictions

ODU drop cable	Power over Ethernet	Ethernet supported	Maximum cable length (*1)
SFP (copper) – linked device	None	100BASE-TX	100 m (330 ft)

(\*1) Maximum length of Ethernet cable from the ODU to the linked device.

## Outdoor copper Cat5e Ethernet cable

For copper Cat5e Ethernet connections from the ODU to the PSU and other devices, use Cat5e cable that is gel-filled and shielded with copper-plated steel, for example Superior Essex type BBDGe. This is known as “drop cable” (Figure 11).



### Caution

Always use Cat5e cable that is gel-filled and shielded with copper-plated steel. Alternative types of drop cable are not supported by Cambium Networks.

Order Superior Essex type BBDGe cable from Cambium Networks (Table 21). Other lengths of this cable are available from Superior Essex.

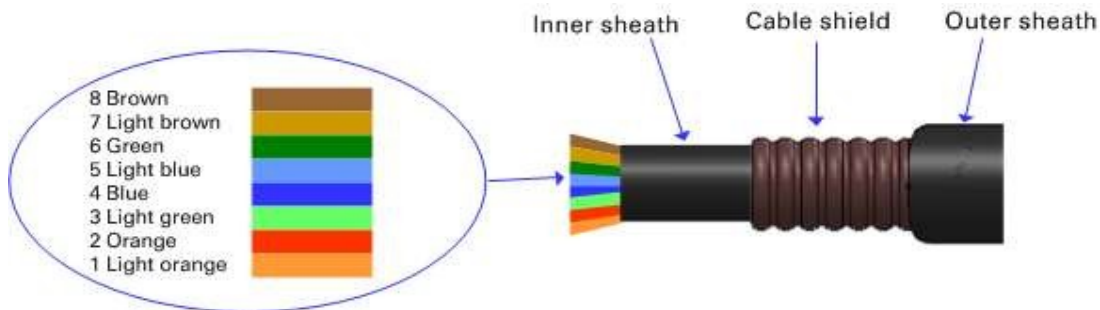
**Figure 10** Outdoor drop cable

**Table 15** Drop cable part numbers

Cambium description	Cambium part number
1000 ft Reel Outdoor Copper Clad CAT5E	WB3175
328 ft (100 m) Reel Outdoor Copper Clad CAT5E	WB3176

## Cable grounding kit

Copper drop cable shields must be bonded to the grounding system in order to prevent lightning creating a potential difference between the structure and cable, which could cause arcing, resulting in fire risk and damage to equipment. Optical cables do not require grounding.

One grounding kit ([Figure 12](#)) is required for each grounding point on the PSU and copper SFP drop cables. Order cable grounding kits from Cambium Networks.



### Caution

To provide adequate protection, all grounding cables must be a minimum size of 10 mm<sup>2</sup> csa (8AWG), preferably 16 mm<sup>2</sup> csa (6AWG), or 25 mm<sup>2</sup> csa (4AWG).

**Figure 11** Cable grounding kit**Table 16** Cable grounding kit part numbers

Cambium description	Cambium part number
Cable Grounding Kits For 1/4" And 3/8" Cable	01010419001

## RJ45 connectors and spare glands

RJ45 connectors are required for plugging Cat5e cables into ODUs, PSUs and other devices. Order RJ45 connectors and crimp tool from Cambium Networks ([Table 25](#)).



### Note

The RJ45 connectors and crimp tool listed in [Table 25](#) work with Superior Essex type BBDGe cable (as supplied by Cambium Networks). They may not work with other types of cable.

The ODU is supplied with one environmental sealing gland for the drop cable. However, this is not suitable when surge protection is required: EMC glands must be used instead. If extra glands are required, order them from Cambium Networks (in packs of 10) ([Table 25](#)).

One long EMC strain relief gland ([Figure 16](#)) is included in each SFP module kit. This is longer than the standard cable gland as it must house an SFP module plugged into the ODU.

**Figure 12** Cable gland



**Table 17** RJ45 connector and spare gland part numbers

Cambium description	Cambium part number
Tyco/AMP, Mod Plug RJ45 Unscreened, 100 pack	WB3177
Tyco/AMP Crimp Tool	WB3211
RJ-45 Spare Grounding Gland - PG16 size (Qty. 10)	N000065L033

## Cable hoisting grip

One or more grips are required for hoisting the drop cable up to the ODU without damaging the gland or RJ45 plug ([Figure 14](#)). They are not supplied by Cambium Networks.

**Figure 13** Cable hoisting grip

## Drop cable tester

The drop cable tester is an optional item for testing the resistances between the RJ45 pins of the drop cable. A suitable example is the Modapt adaptor manufactured by The Siemon Company.

## Indoor Cat5e cable

To connect the PSU to network terminating equipment, use indoor Cat5e cable. The ODU network connection implements automatic MDI/MDI-X sensing and pair swapping, allowing connection to networking equipment that requires cross-over cables (MDI-X networks) or straight-through cables (MDI Networks).

## SFP module kits

SFP module kits allow connection of a PTP 550 Series ODU to a network over a Gigabit Ethernet interface in one of the following full-duplex modes:

- Optical Gigabit Ethernet: 1000BASE-LX or 1000BASE-SX
- Copper Gigabit Ethernet: 1000BASE-T

Order SFP module kits from Cambium Networks ([Table 26](#)).

**Table 18** SFP module kit part numbers

Cambium description	Cambium part number
PTP 550 SFP Interface for Gigabit Ethernet 1000BaseT per ODU	C050055L001A
PTP 550 SFP Multi-mode Optical 1000BaseSX SFP Interface per ODU	C050055L002A
PTP 550 SFP Single Mode Optical 1000BaseLX SFP Interface per ODU	C050055L003A

To compare the capabilities of the two optical SFP modules, refer to [Table 27](#) and [Table 28](#).

**Table 19** Single Mode Optical SFP Interface per ODU (part number C000065L008)

Core/ cladding (microns)	Mode	Bandwidth at 1310 nm (MHz/km)	Maximum length of optical interface	Insertion loss (dB)
62.5/125	Multi	500	550 m (1800 ft)	1.67

50/125	Multi	400	550 m (1800 ft)	0.07
50/125	Multi	500	550 m (1800 ft)	1.19
10/125	Single	N/A	5000 m (16400 ft)	0.16

**Table 20** Multi-mode Optical SFP Interface per ODU (part number C000065L009)

Core/ cladding (microns)	Mode	Bandwidth at 850 nm (MHz/km)	Maximum length of optical interface	Insertion loss (dB)
62.5/125	Multi	160	220 m (720 ft)	2.38
62.5/125	Multi	200	275 m (900 ft)	2.6
50/125	Multi	400	500 m (1640 ft)	3.37
50/125	Multi	500	550 m (1800 ft)	3.56

The upgrade kits contain the following components:

- Optical or copper SFP transceiver module (Figure 15)
- Long EMC strain relief cable gland (Figure 16)

**Figure 14** Optical or copper SFP transceiver module

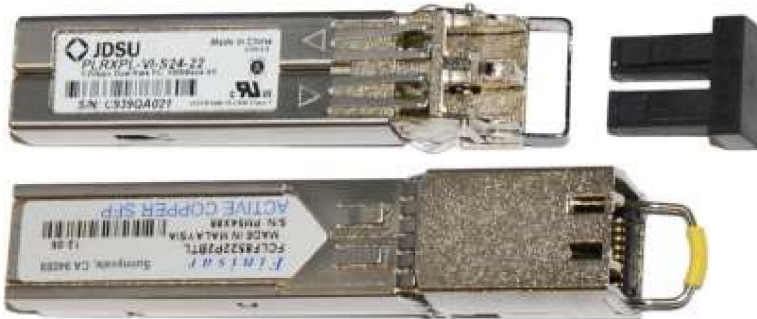

**Figure 15** Long cable gland



**Note**

PTP 550 does not support the Synchronous Ethernet or 1588 Transparent Clock features using copper SFP transceivers.

## Optical cable and connectors

Order an optical cable with LC connectors from a specialist fabricator, quoting the specification shown in [Figure 17](#). It must be the correct length to connect the ODU to the other device. LC connectors should be supplied with dust caps to prevent dust build up.

**Figure 16** Optical optic cable and connector specification

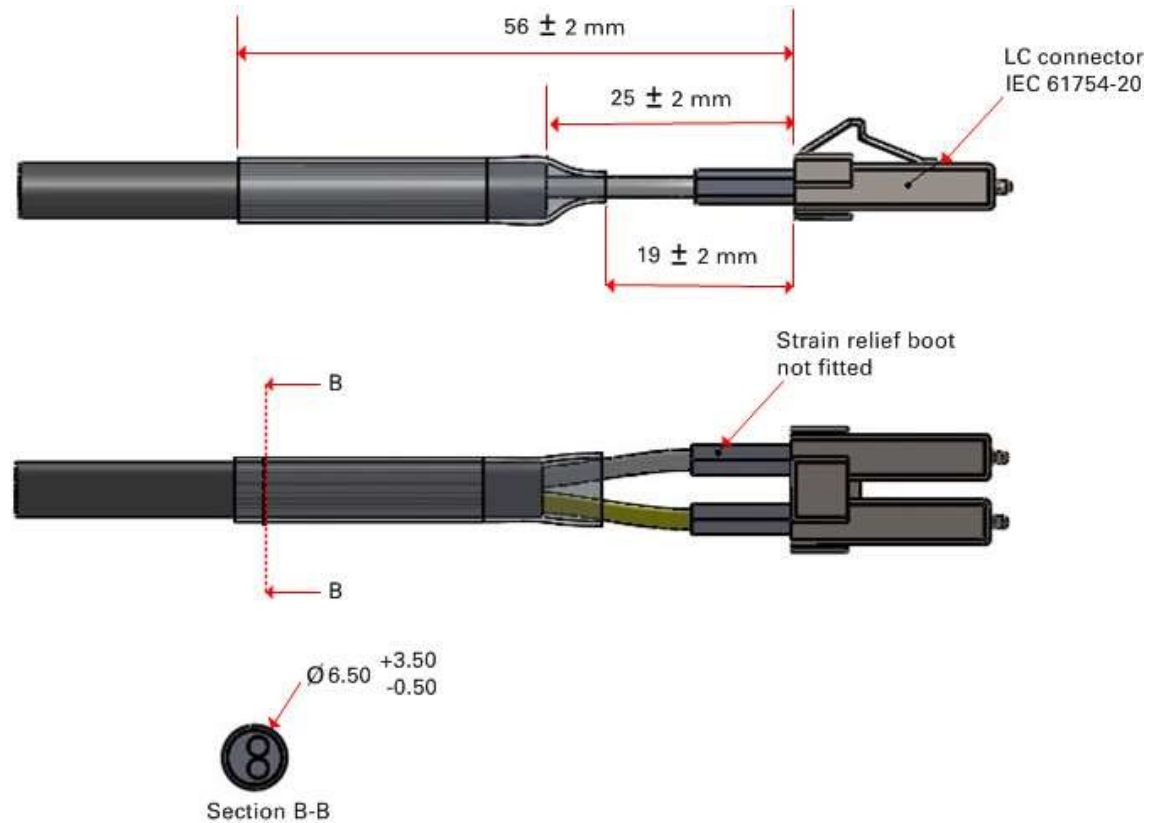



## Surge suppression unit

---

Structures, equipment and people must be protected against power surges (typically caused by lightning) by conducting the surge current to ground via a separate preferential solid path.

The actual degree of protection required depends on local conditions and applicable local regulations. To adequately protect an installation, both ground bonding and transient voltage surge suppression are required.

Network operators should always follow best-practices for grounding and lightning protection. Doing so will minimize network outages and reduce the associated costs of tower climbs and equipment repair/replacement.



### Note

Lightning-prone installations can be improved by:

Installing a surge suppressor near the device (transient surge suppression)

Grounding the device to the pole (ground bonding)

Lowering the device such that it is not the highest metallic object on the pole.

## Gigabit Ethernet Surge Suppressor

The Gigabit Ethernet Surge Suppressor is critical for lightning protection to minimize the potential for damage.



**Table 21** Surge suppressor component part numbers

Cambium description	Cambium part number
Gigabit Surge Suppressor (56V)	C000000L033A

---

## Chapter 3: System planning

---

This chapter provides information to help the user to plan a PTP 550 link.

The following topics are described in this chapter:

- [Site planning](#) on page 3-22 describes factors to be considered when planning the proposed link end sites, including grounding, lightning protection and equipment location.
- [Radio spectrum planning](#) on page 3-26 describes how to plan PTP 550 links to conform to the regulatory restrictions that apply in the country of operation.
- [Link planning](#) on page 3-29 describes factors to be taken into account when planning links, such as range, path loss and throughput.
- [Planning for connectorized units](#) on page 3-31 describes factors to be taken into account when planning to use connectorized ODUs with external antennas in PTP 550 links.
- [Network management planning](#) on page 3-34 describes how to plan for PTP 550 links to be managed remotely using SNMP.
- [Security planning](#) on page 3-35 describes how to plan for PTP 550 links to operate in secure mode.
- [System threshold](#) on page 3-36 contains tables that specify the system threshold (dBm), output power (dBm) and maximum link loss (dB) per channel bandwidth and modulation mode.

## Site planning

---

This section describes factors to be considered when planning the proposed link end sites, including grounding, lightning protection and equipment location for the ODU and PSU.

### Grounding and lightning protection

---

**Warning**

Electro-magnetic discharge (lightning) damage is not covered under warranty. The recommendations in this guide, when followed correctly, give the user the best protection from the harmful effects of EMD. However 100% protection is neither implied nor possible.

---

Structures, equipment and people must be protected against power surges (typically caused by lightning) by conducting the surge current to ground via a separate preferential solid path. The actual degree of protection required depends on local conditions and applicable local regulations. To adequately protect a PTP 550 installation, both ground bonding and transient voltage surge suppression are required.

Full details of lightning protection methods and requirements can be found in the international standards IEC 61024-1 and IEC 61312-1, the U.S. National Electric Code ANSI/NFPA No. 70-1984 or section 54 of the Canadian Electric Code.

**Note**

International and national standards take precedence over the requirements in this guide.

---

### Lightning protection zones

Use the rolling sphere method ([Figure 23](#)) to determine where it is safe to mount equipment. An imaginary sphere, typically 50 meters in radius, is rolled over the structure. Where the sphere rests against the ground and a strike termination device (such as a finial or ground bar), all the space under the sphere is considered to be in the zone of protection (Zone B). Similarly, where the sphere rests on two finials, the space under the sphere is considered to be in the zone of protection.

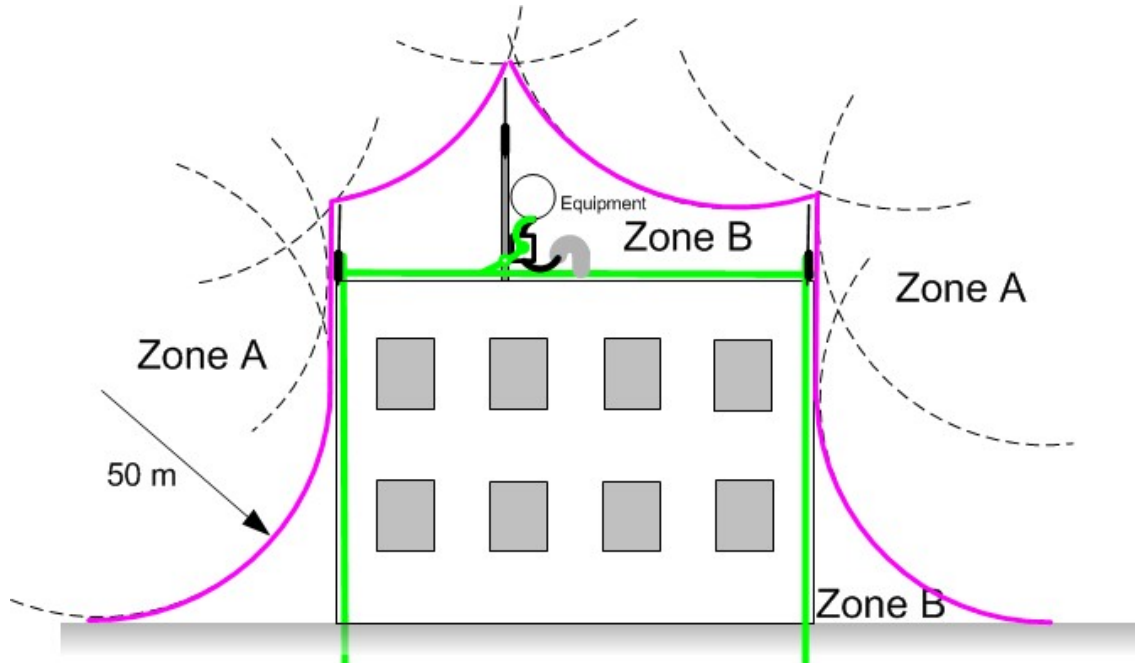
**Figure 17** Rolling sphere method to determine the lightning protection zones

Zone A: In this zone a direct lightning strike is possible. Do not mount equipment in this zone.

Zone B: In this zone, direct EMD (lightning) effects are still possible, but mounting in this zone significantly reduces the possibility of a direct strike. Mount equipment in this zone.

**Warning**

Never mount equipment in Zone A. Mounting in Zone A may put equipment, structures and life at risk.

## Site grounding system

Confirm that the site has a correctly installed grounding system on a common ground ring with access points for grounding PTP 550 equipment.

If the outdoor equipment is to be installed on the roof of a high building (Figure 20), confirm that the following additional requirements are met:

- A grounding conductor is installed around the roof perimeter to form the main roof perimeter lightning protection ring.
- Air terminals are installed along the length of the main roof perimeter lightning protection ring, typically every 6.1m (20ft).
- The main roof perimeter lightning protection ring contains at least two down conductors connected to the grounding electrode system. The down conductors should be physically separated from one another, as far as practical.

## ODU and external antenna location

Find a location for the ODU (and external antenna for connectorized units) that meets the following requirements:

- The equipment is high enough to achieve the best radio path.
- People can be kept a safe distance away from the equipment when it is radiating. The safe separation distances are defined in [Calculated distances](#) on page 4-65.
- The equipment is lower than the top of the supporting structure (tower, mast or building) or its lightning air terminal.
- If the ODU is connectorized, select a mounting position that gives it maximum protection from the elements, but still allows easy access for connecting and weatherproofing the cables. To minimize cable losses, select a position where the antenna cable lengths can be minimized. If diverse or two external antennas are being deployed, it is not necessary to mount the ODU at the midpoint of the antennas.

## ODU wind loading

Ensure that the ODU and the structure on which it is mounted are capable of withstanding the prevalent wind speeds at a proposed PTP 550 site. Wind speed statistics should be available from national meteorological offices.

The ODU and its mounting bracket are capable of withstanding wind speeds of up to 325 kph (200 mph).

Wind blowing on the ODU will subject the mounting structure to significant lateral force. The magnitude of the force depends on both wind strength and surface area of the ODU. Wind loading is estimated using the following formulae:

- Force (in newtons) =  $0.5 \times \rho \times V^2 \times A \times C_d$ 
  - “ $\rho$ ” is the density of air = 1.225 kg/m<sup>3</sup>,
  - “ $V$ ” is the wind speed in meters per second,
  - “ $A$ ” is the projected surface area of the ODU in square meters, and
  - “ $C_d$ ” is the drag coefficient = 1.385.

The drag coefficient has been measured when the cover plate or antenna is perpendicular to the air flow.

Applying these formulae to the PTP 550 ODU at different wind speeds, the resulting wind loadings are shown in [Table 29](#).

**Table 22** ODU wind loading (newtons)

Type of ODU	Max surface area (square meters)	Wind speed (kilometers per hour)				
		225	250	275	300	325
Integrated (23 dBi)	0.130	308 N	380 N	460 N	547 N	643 N
Connectorized	0.051	169 N	208 N	253 N	300 N	353 N

Equivalent results in US customary units are shown in [Table 30](#).

**Table 23** ODU wind loading (pounds force )

Type of ODU	Max surface area (square feet)	Wind speed (miles per hour)				
		140	155	170	185	200

Integrated (23 dBi)	1.40	69 lb	85 lb	103 lb	123 lb	145 lb
Connectorized	0.55	38 lb	47 lb	57 lb	67 lb	79 lb

If an external antenna is installed, add the wind loading of the antenna to that of the ODU. The antenna manufacturer should be able to quote wind loading.

## PSU AC power supply

Always use an appropriately rated and approved AC supply cord-set in accordance with the regulations of the country of use.

## PSU location

Find a location for the PSU that meets the following requirements:

- The AC Power Injector can be mounted on a flat surface.
- The PSU is kept dry, with no possibility of condensation, flooding or rising damp.
- The PSU is located in an environment where it is not likely to exceed its operational temperature rating, allowing for natural convection cooling.
- The PSU can be connected to the ODU drop cable and network terminating equipment.
- The PSU can be connected to a compatible power supply.

## Drop cable grounding points

To estimate how many grounding kits are required for each drop cable, refer to the site installation diagrams (Figure 18, Figure 19 and Figure 20) and use the following criteria:

- The drop cable shield must be grounded near the ODU at the first point of contact between the drop cable and the mast, tower or building.
- The drop cable shield must be grounded at the building entry point.

For mast or tower installations (Figure 18), use the following additional criteria:

- The drop cable shield must be grounded at the bottom of the tower, near the vertical to horizontal transition point. This ground cable must be bonded to the tower or tower ground bus bar (TGB), if installed.
- If the tower is greater than 61 m (200 ft) in height, the drop cable shield must be grounded at the tower midpoint, and at additional points as necessary to reduce the distance between ground cables to 61 m (200 ft) or less.
- In high lightning-prone geographical areas, the drop cable shield must be grounded at spacing between 15 to 22 m (50 to 75 ft). This is especially important on towers taller than 45 m (150 ft).

For roof installations (Figure 20), use the following additional criteria:

- The drop cable shield must be bonded to the building grounding system at its top entry point (usually on the roof).
- The drop cable shield must be bonded to the building grounding system at the entry point to the equipment room.

## Radio spectrum planning

---

This section describes how to plan PTP 550 links to conform to the regulatory restrictions that apply in the country of operation.



### Caution

It is the responsibility of the user to ensure that the PTP product is operated in accordance with local regulatory limits.



### Note

Contact the applicable radio regulator to find out whether or not registration of the PTP 550 link is required.

## General wireless specifications

[Table 31](#) lists the wireless specifications that apply to all PTP 550 frequency bands. [Table 32](#) lists the wireless specifications that are specific to a single frequency band.

**Table 24** PTP 550 wireless specifications (all variants)

Item	Specification
Channel selection	Manual selection (fixed frequency)
Manual power control	To avoid interference to other users of the band, maximum power can be set lower than the default power limit.
Integrated antenna type	23 dBi Flat plate antenna
Duplex schemes	Symmetric fixed, asymmetric fixed
Range	Line-of-Sight: 200 km (122 miles)
Over-the-air encryption	AES 128-bit
Error Correction	FEC

**Table 25** PTP 550 wireless specifications (per frequency band)

Item	5.1 GHz	5.2 GHz	5.4 GHz	5.8 GHz
RF band (MHz)	5150–5250	5250–5350	5470–5725	5725–5875
Channel bandwidth (MHz)	20, 40, 80	20, 40, 80	20, 40, 80	20, 40, 80
Typical antenna gain (integrated)	23 dBi	23 dBi	23 dBi	23 dBi
Antenna beamwidth (integrated)	8°	8°	8°	8°

## Regulatory limits

Many countries impose EIRP limits (Allowed EIRP) on products operating in the bands used by the PTP 550 Series. For example, in the 5.4 GHz and 5.8 GHz bands, these limits are calculated as follows:

- In the 5.4 GHz band (5470 MHz to 5725 MHz), the EIRP must not exceed the lesser of 30 dBm or  $(17 + 10 \times \text{Log Channel width in MHz})$  dBm.
- In the 5.8 GHz band (5725 MHz to 5875 MHz), the EIRP must not exceed the lesser of 36 dBm or  $(23 + 10 \times \text{Log Channel width in MHz})$  dBm.

Some countries (for example the USA) impose conducted power limits on products operating in the 5.8 GHz band.

## Conforming to the limits

Ensure the link is configured to conform to local regulatory requirements by configuring the **Country** parameter (located in the web management interface at **Configuration > Radio**). When using connectorized ODUs with external antennas, also ensure that the antenna gain is configured correctly in the ODU.

## Available spectrum

The available spectrum for operation depends on the regulatory band. When configured with the appropriate country code, the unit will only allow operation on those channels which are permitted by the regulations.

Certain regulations have allocated certain channels as unavailable for use:

- ETSI has allocated part of the 5.4 GHz band to weather radar.



The number and identity of channels barred by the country code and regulatory band is dependent on the channel bandwidth and channel raster selected.

## Channel bandwidth

Select the required channel bandwidth for the link. The selection depends upon the regulatory band selected. The wider the channel bandwidth, the greater the capacity. As narrower channel bandwidths take up less spectrum, selecting a narrow channel bandwidth may be a better choice when operating in locations where the spectrum is very busy.

# Link planning

---

This section describes factors to be taken into account when planning links, such as range, obstacles path loss and throughput. LINKPlanner is recommended.

## LINKPlanner

The Cambium LINKPlanner software and user guide may be downloaded from the support website (see [Contacting Cambium Networks](#) on page 1).

LINKPlanner imports path profiles and predicts data rates and reliability over the path. It allows the system designer to try different antenna heights and RF power settings. It outputs an installation report that defines the parameters to be used for configuration, alignment and operation. Use the installation report to compare predicted and actual link performance.

## Range and obstacles

Calculate the range of the link and identify any obstacles that may affect radio performance.

Perform a survey to identify all the obstructions (such as trees or buildings) in the path and to assess the risk of interference. This information is necessary in order to achieve an accurate link feasibility assessment.

The PTP 550 Series is designed to operate in Non-Line-of-Sight (NLoS) and Line-of-Sight (LoS) environments. An NLoS environment is one in which there is no optical line-of-sight, that is, there are obstructions between the antennas.

The PTP 550 Series will operate at ranges from 100 m (330 ft) to 200 km (122 miles). Operation of the system will depend on obstacles in the path between the units. Operation at 40 km (25 miles) or above will require a near line-of-sight path. Operation at 100 m (330 ft) could be achieved with one unit totally obscured from the other unit, but with the penalty of transmitting at higher power in a non-optimal direction, thereby increasing interference in the band.

## Path loss

Path loss is the amount of attenuation the radio signal undergoes between the two ends of the link. The path loss is the sum of the attenuation of the path if there were no obstacles in the way (Free Space Path Loss), the attenuation caused by obstacles (Excess Path Loss) and a margin to allow for possible fading of the radio signal (Fade Margin). The following calculation needs to be performed to judge whether a particular link can be installed:

$$L_{free\_space} + L_{excess} + L_{fade} + L_{seasonal} < L_{capability}$$

Where:

Is:

$L_{free\_space}$	Free Space Path Loss (dB)
$L_{excess}$	Excess Path Loss (dB)
$L_{fade}$	Fade Margin Required (dB)

$L_{seasonal}$	Seasonal Fading (dB)
$L_{capability}$	Equipment Capability (dB)

## Adaptive modulation

Adaptive modulation ensures that the highest throughput that can be achieved instantaneously will be obtained, taking account of propagation and interference. When the link has been installed, web pages provide information about the link loss currently measured by the equipment, both instantaneously and averaged. The averaged value will require maximum seasonal fading to be added, and then the radio reliability of the link can be computed.

For details of the system threshold, output power and link loss for each frequency band in all modulation modes for all available channel bandwidths, refer to [System threshold](#) on page 3-36.

# Planning for connectorized units

---

This section describes factors to be taken into account when planning to use connectorized ODUs with external antennas in PTP 550 links.

## When to install connectorized units

The majority of radio links can be successfully deployed with the integrated ODU. However, the integrated units may not be sufficient in some areas, for example:

- Where the path is heavily obscured by dense woodland on an NLOS link.
- Where long LOS links (>23 km or >14 miles) are required.
- Where there are known to be high levels of interference.

LINKPlanner can be used to identify these areas of marginal performance.

In these areas, connectorized ODUs and external antennas should be used.

## Choosing external antennas

When selecting external antennas, consider the following factors:

- The required antenna gain.
- Ease of mounting and alignment.
- Antenna polarization:
  - For a simple installation process, select one dual-polarization antenna (as the integrated antenna) at each end.

**Note**

Enter the antenna gain and cable loss into the Installation Wizard, if the country selected has an EIRP limit, the corresponding maximum transmit power will be calculated automatically by the unit.

---

**Note**

Under Industry Canada regulations, this radio transmitter may only operate using an antenna of a type and maximum (or lesser) gain approved for the transmitter by Industry Canada. To reduce potential radio interference to other users, the antenna type and its gain should be so chosen that the equivalent isotropically radiated power (EIRP) is not more than that necessary for successful communication.

Conformément à la réglementation d'Industrie Canada, le présent émetteur radio peut fonctionner avec une antenne d'un type et d'un gain maximal (ou inférieur) approuvé pour l'émetteur par Industrie Canada. Dans le but de réduire les risques de brouillage radioélectrique à l'intention des autres utilisateurs, il faut choisir le type d'antenne et son gain de sorte que la puissance isotrope rayonnée équivalente (p.i.r.e.) ne dépasse pas l'intensité nécessaire à l'établissement d'une communication satisfaisante.

---



# Data network planning

---

This section describes factors to be considered when planning PTP 550 data networks.

## Ethernet interfaces

The PTP 550 Ethernet ports conform to the specifications listed in [Table 38](#).

**Table 26** PTP 550 Ethernet bridging specifications

Ethernet Bridging	Specification
Protocol	IEEE802.1; IEEE802.1p; IEEE802.3 compatible
QoS	Three wireless interface priority queues
Interfaces	100BASE-TX (not applicable to SFP), 1000BASE-T, 1000BASE-SX, 1000BASE-LX MDI/MDIX auto crossover supported
Max Ethernet frame size	1538 bytes
Service classes for traffic	3 classes

Practical Ethernet rates depend on network configuration and higher layer protocols. Over the air throughput is capped to the rate of the Ethernet interface at the receiving end of the link.

## IP interface

Select the IP version for the IP interface of the ODU management agent. PTP 550 can operate in IPv4 mode, IPv6 mode, or in a dual IPv4/IPv6 mode. Choose one IPv4 address and/or one IPv6 address for the IP interface of the ODU management agent. The IP address or addresses must be unique and valid for the connected network segment and VLAN.

Find out the correct subnet mask (IPv4) or prefix length (IPv6) and gateway IP address for this network segment and VLAN.

Ensure that the design of the data network permits bidirectional routing of IP datagrams between network management systems and the ODUs. For example, ensure that the gateway IP address identifies a router or other gateway that provides access to the rest of the data network.

## Green Ethernet switches

Do not connect PTP 550 units to Ethernet networking products that control the level of the transmitted Ethernet signal based on the measured length of the Ethernet link, for example Green Ethernet products manufactured by D-Link Corporation. The Ethernet interfaces in these networking products do not work correctly when connected directly to the PTP 550 PSU.

# Network management planning

---

This section describes how to plan for PTP 550 links to be managed remotely using SNMP.

## Enabling SNMP

Enable the SNMP interface for use by configuring the following attributes in the SNMP Configuration page:

- Read-Only Community String
- Read-Write Community String
- System Name
- System Description
- System Location
- Traps
- Trap Community String

# Security planning

---

This section describes how to plan for PTP 550 links to operate in secure mode.

## Planning for NTP operation

---

**Note**

PTP 550 does not have a battery-powered clock, so the set time is lost each time the ODU is powered down. To avoid the need to manually set the time after each reboot, use NTP server synchronization.

---

Before starting to configure Simple Network Time Protocol (NTP):

- Identify the time zone and daylight saving requirements that apply to the system.
- If NTP server synchronization is required, identify the IP address of one or two NTP servers.



## System threshold

---

Use the following table to reference system threshold (dBm) for the PTP 550 system:

**Table 27** 5 GHz: system threshold (dBm)

Modulation mode	20 MHz	40 MHz	80 MHz
Lowest MCS	-88	-85	-82
Highest MCS	-62	-59	-55

---

## Chapter 4: Legal and regulatory information

---

This chapter provides end user license agreements and regulatory notifications.



### Caution

Intentional or unintentional changes or modifications to the equipment must not be made unless under the express consent of the party responsible for compliance. Any such modifications could void the user's authority to operate the equipment and will void the manufacturer's warranty.



### Attention

Changements ou modifications Intentionnels ou non de l'équipement ne doivent pas être entrepris sans l'autorisation de l'organisme responsable de la déclaration de conformité. Ces modifications ou changements pourraient invalider le droit de l'utilisateur à utiliser cet appareil et annuleraient la garantie du fabricant.

---

The following topics are described in this chapter:

- [Cambium Networks end user license agreement](#) on page 4-2 contains the Cambium and third party license agreements for the PTP 550 Series products.
- [Compliance with safety standards](#) on page 4-63 lists the safety specifications against which the PTP 550 has been tested and certified. It also describes how to keep RF exposure within safe limits.
- [Compliance with radio regulations](#) on page 4-68 describes how the PTP 550 complies with the radio regulations that are in force in various countries, and contains notifications made to regulatory bodies for the PTP 550.

# Cambium Networks end user license agreement

---

## Definitions

In this Agreement, the word “Software” refers to the set of instructions for computers, in executable form and in any media, (which may include diskette, CD-ROM, downloadable internet, hardware, or firmware) licensed to you. The word “Documentation” refers to electronic or printed manuals and accompanying instructional aids licensed to you. The word “Product” refers to Cambium Networks’ fixed wireless broadband devices for which the Software and Documentation is licensed for use.

## Acceptance of this agreement

In connection with Cambium Networks’ delivery of certain proprietary software or products containing embedded or pre-loaded proprietary software, or both, Cambium Networks is willing to license this certain proprietary software and the accompanying documentation to you only on the condition that you accept all the terms in this End User License Agreement (“Agreement”).

IF YOU DO NOT AGREE TO THE TERMS OF THIS AGREEMENT, DO NOT USE THE PRODUCT OR INSTALL THE SOFTWARE. INSTEAD, YOU MAY, FOR A FULL REFUND, RETURN THIS PRODUCT TO THE LOCATION WHERE YOU ACQUIRED IT OR PROVIDE WRITTEN VERIFICATION OF DELETION OF ALL COPIES OF THE SOFTWARE. ANY USE OF THE SOFTWARE, INCLUDING BUT NOT LIMITED TO USE ON THE PRODUCT, WILL CONSTITUTE YOUR ACCEPTANCE TO THE TERMS OF THIS AGREEMENT.

## Grant of license

Cambium Networks Limited (“Cambium”) grants you (“Licensee” or “you”) a personal, nonexclusive, non-transferable license to use the Software and Documentation subject to the Conditions of Use set forth in “**Conditions of use**” and the terms and conditions of this Agreement. Any terms or conditions relating to the Software and Documentation appearing on the face or reverse side of any purchase order, purchase order acknowledgment or other order document that are different from, or in addition to, the terms of this Agreement will not be binding on the parties, even if payment is accepted.

## Conditions of use

Any use of the Software and Documentation outside of the conditions set forth in this Agreement is strictly prohibited and will be deemed a breach of this Agreement.

1. Only you, your employees or agents may use the Software and Documentation. You will take all necessary steps to insure that your employees and agents abide by the terms of this Agreement.
2. You will use the Software and Documentation (i) only for your internal business purposes; (ii) only as described in the Software and Documentation; and (iii) in strict accordance with this Agreement.
3. You may use the Software and Documentation, provided that the use is in conformance with the terms set forth in this Agreement.
4. Portions of the Software and Documentation are protected by United States copyright laws, international treaty provisions, and other applicable laws. Therefore, you must treat the Software like any other copyrighted material (for example, a book or musical recording) except that you may either: (i) make 1 copy of the transportable part of the Software (which typically is supplied on diskette, CD-ROM, or downloadable internet), solely for back-up purposes; or (ii) copy the transportable part of the Software to a PC hard disk, provided you keep the original solely for back-up purposes. If the Documentation is in printed form, it may not be copied. If the Documentation is in electronic form, you may print out 1 copy, which then may not be copied. With regard to the copy made for backup or archival purposes, you agree to reproduce any Cambium Networks copyright notice, and other proprietary legends appearing thereon. Such copyright notice(s) may appear in any of several forms, including machine-readable form, and you agree to reproduce such notice in each form in which it appears, to the extent it is physically possible to do so. Unauthorized duplication of the Software or Documentation constitutes copyright infringement, and in the United States is punishable in federal court by fine and imprisonment.
5. You will not transfer, directly or indirectly, any product, technical data or software to any country for which the United States Government requires an export license or other governmental approval without first obtaining such license or approval.

## Title and restrictions

If you transfer possession of any copy of the Software and Documentation to another party outside of the terms of this agreement, your license is automatically terminated. Title and copyrights to the Software and Documentation and any copies made by you remain with Cambium Networks and its licensors. You will not, and will not permit others to: (i) modify, translate, decompile, bootleg, reverse engineer, disassemble, or extract the inner workings of the Software or Documentation, (ii) copy the look-and-feel or functionality of the Software or Documentation; (iii) remove any proprietary notices, marks, labels, or logos from the Software or Documentation; (iv) rent or transfer all or some of the Software or Documentation to any other party without Cambium's prior written consent; or (v) utilize any computer software or hardware which is designed to defeat any copy protection device, should the Software and Documentation be equipped with such a protection device. If the Software and Documentation is provided on multiple types of media (such as diskette, CD-ROM, downloadable internet), then you will only use the medium which best meets your specific needs, and will not loan, rent, lease, or transfer the other media contained in the package without Cambium's written consent. Unauthorized copying of the Software or Documentation, or failure to comply with any of the provisions of this Agreement, will result in automatic termination of this license.

## Confidentiality

You acknowledge that all Software and Documentation contain valuable proprietary information and trade secrets and that unauthorized or improper use of the Software and Documentation will result in irreparable harm to Cambium Networks for which monetary damages would be inadequate and for which Cambium Networks will be entitled to immediate injunctive relief. If applicable, you will limit access to the Software and Documentation to those of your employees and agents who need to use the Software and Documentation for your internal business purposes, and you will take appropriate action with those employees and agents to preserve the confidentiality of the Software and Documentation, using the same degree of care to avoid unauthorized or improper disclosure as you use for the protection of your own proprietary software, but in no event less than reasonable care.

You have no obligation to preserve the confidentiality of any proprietary information that: (i) was in the public domain at the time of disclosure; (ii) entered the public domain through no fault of yours; (iii) was given to you free of any obligation to keep it confidential; (iv) is independently developed by you; or (v) is disclosed as required by law provided that you notify Cambium Networks prior to such disclosure and provide Cambium Networks with a reasonable opportunity to respond.

## Right to use Cambium's name

Except as required in “**Conditions of use**”, you will not, during the term of this Agreement or thereafter, use any trademark of Cambium Networks, or any word or symbol likely to be confused with any Cambium Networks trademark, either alone or in any combination with another word or words.

## Transfer

The Software and Documentation may not be transferred to another party without the express written consent of Cambium Networks, regardless of whether or not such transfer is accomplished by physical or electronic means. Cambium's consent may be withheld at its discretion and may be conditioned upon transferee paying all applicable license fees and agreeing to be bound by this Agreement.

## Updates

During the first 12 months after purchase of a Product, or during the term of any executed Maintenance and Support Agreement for the Product, you are entitled to receive Updates. An “Update” means any code in any form which is a bug fix, patch, error correction, or minor enhancement, but excludes any major feature added to the Software. Updates are available for download at the support website.

Major features may be available from time to time for an additional license fee. If Cambium Networks makes available to you major features and no other end user license agreement is provided, then the terms of this Agreement will apply.

## Maintenance

Except as provided above, Cambium Networks is not responsible for maintenance or field service of the Software under this Agreement.

## Disclaimer

CAMBIUM NETWORKS DISCLAIMS ALL WARRANTIES OF ANY KIND, WHETHER EXPRESS, IMPLIED, STATUTORY, OR IN ANY COMMUNICATION WITH YOU. CAMBIUM NETWORKS SPECIFICALLY DISCLAIMS ANY WARRANTY INCLUDING THE IMPLIED WARRANTIES OF MERCHANTABILITY, NONINFRINGEMENT, OR FITNESS FOR A PARTICULAR PURPOSE. THE SOFTWARE AND DOCUMENTATION ARE PROVIDED "AS IS." CAMBIUM NETWORKS DOES NOT WARRANT THAT THE SOFTWARE WILL MEET YOUR REQUIREMENTS, OR THAT THE OPERATION OF THE SOFTWARE WILL BE UNINTERRUPTED OR ERROR FREE, OR THAT DEFECTS IN THE SOFTWARE WILL BE CORRECTED. CAMBIUM NETWORKS MAKES NO WARRANTY WITH RESPECT TO THE CORRECTNESS, ACCURACY, OR RELIABILITY OF THE SOFTWARE AND DOCUMENTATION. Some jurisdictions do not allow the exclusion of implied warranties, so the above exclusion may not apply to you.

## Limitation of liability

IN NO EVENT SHALL CAMBIUM NETWORKS BE LIABLE TO YOU OR ANY OTHER PARTY FOR ANY DIRECT, INDIRECT, GENERAL, SPECIAL, INCIDENTAL, CONSEQUENTIAL, EXEMPLARY OR OTHER DAMAGE ARISING OUT OF THE USE OR INABILITY TO USE THE PRODUCT (INCLUDING, WITHOUT LIMITATION, DAMAGES FOR LOSS OF BUSINESS PROFITS, BUSINESS INTERRUPTION, LOSS OF BUSINESS INFORMATION OR ANY OTHER PECUNIARY LOSS, OR FROM ANY BREACH OF WARRANTY, EVEN IF CAMBIUM NETWORKS HAS BEEN ADVISED OF THE POSSIBILITY OF SUCH DAMAGES. (Some states do not allow the exclusion or limitation of incidental or consequential damages, so the above exclusion or limitation may not apply to you.) IN NO CASE SHALL CAMBIUM'S LIABILITY EXCEED THE AMOUNT YOU PAID FOR THE PRODUCT.

## U.S. government

If you are acquiring the Product on behalf of any unit or agency of the U.S. Government, the following applies. Use, duplication, or disclosure of the Software and Documentation is subject to the restrictions set forth in subparagraphs (c) (1) and (2) of the Commercial Computer Software – Restricted Rights clause at FAR 52.227-19 (JUNE 1987), if applicable, unless being provided to the Department of Defense. If being provided to the Department of Defense, use, duplication, or disclosure of the Products is subject to the restricted rights set forth in subparagraph (c) (1) (ii) of the Rights in Technical Data and Computer Software clause at DFARS 252.227-7013 (OCT 1988), if applicable. Software and Documentation may or may not include a Restricted Rights notice, or other notice referring specifically to the terms and conditions of this Agreement. The terms and conditions of this Agreement will each continue to apply, but only to the extent that such terms and conditions are not inconsistent with the rights provided to you under the aforementioned provisions of the FAR and DFARS, as applicable to the particular procuring agency and procurement transaction.

## Term of license

Your right to use the Software will continue in perpetuity unless terminated as follows. Your right to use the Software will terminate immediately without notice upon a breach of this Agreement by you. Within 30 days after termination of this Agreement, you will certify to Cambium Networks in writing that through your best efforts, and to the best of your knowledge, the original and all copies, in whole or in part, in any form, of the Software and all related material and Documentation, have been destroyed, except that, with prior written consent from Cambium Networks, you may retain one copy for archival or backup purposes. You may not sublicense, assign or transfer the license or the Product, except as expressly provided in this Agreement. Any attempt to otherwise sublicense, assign or transfer any of the rights, duties or obligations hereunder is null and void.

## Governing law

This Agreement is governed by the laws of the United States of America to the extent that they apply and otherwise by the laws of the State of Illinois.

## Assignment

This agreement may not be assigned by you without Cambium's prior written consent.

## Survival of provisions

The parties agree that where the context of any provision indicates an intent that it survives the term of this Agreement, then it will survive.

## Entire agreement

This agreement contains the parties' entire agreement regarding your use of the Software and may be amended only in writing signed by both parties, except that Cambium Networks may modify this Agreement as necessary to comply with applicable laws.

## Third party software

The software may contain one or more items of Third-Party Software supplied by other third-party suppliers. The terms of this Agreement govern your use of any Third-Party Software UNLESS A SEPARATE THIRD-PARTY SOFTWARE LICENSE IS INCLUDED, IN WHICH CASE YOUR USE OF THE THIRD-PARTY SOFTWARE WILL THEN BE GOVERNED BY THE SEPARATE THIRD-PARTY LICENSE.

## Source Code Requests

Where required under the terms of the open source software license applicable to Cambium's use of each of the following open source software packages, for at least three (3) years from the date of your receipt of the copy of such open source software, Cambium will provide to any party who contacts us at the



contact information provided below a copy of the source code for the version of the requested open source software used in this Cambium product.

Cambium Networks  
Atrium, 3800 Golf Rd #360  
Rolling Meadows, IL 60008

QCA

---

Tensilica

---

Linux Kernel

---

OpenWRT

" GNU GENERAL PUBLIC LICENSE  
Version 2, June 1991

Copyright (C) 1989, 1991 Free Software Foundation, Inc.  
59 Temple Place, Suite 330, Boston, MA 02111-1307 USA  
Everyone is permitted to copy and distribute verbatim copies  
of this license document, but changing it is not allowed.

Preamble

The licenses for most software are designed to take away your freedom to share and change it. By contrast, the GNU General Public License is intended to guarantee your freedom to share and change free software--to make sure the software is free for all its users. This General Public License applies to most of the Free Software Foundation's software and to any other program whose authors commit to using it. (Some other Free Software Foundation software is covered by the GNU Library General Public License instead.) You can apply it to your programs, too.

When we speak of free software, we are referring to freedom, not price. Our General Public Licenses are designed to make sure that you have the freedom to distribute copies of free software (and charge for this service if you wish), that you receive source code or can get it if you want it, that you can change the software or use pieces of it in new free programs; and that you know you can do these things.

To protect your rights, we need to make restrictions that forbid anyone to deny you these rights or to ask you to surrender the rights. These restrictions translate to certain responsibilities for you if you distribute copies of the software, or if you modify it.

For example, if you distribute copies of such a program, whether gratis or for a fee, you must give the recipients all the rights that you have. You must make sure that they, too, receive or can get the source code. And you must show them these terms so they know their rights.

We protect your rights with two steps: (1) copyright the software, and (2) offer you this license which gives you legal permission to copy, distribute and/or modify the software.

Also, for each author's protection and ours, we want to make certain that everyone understands that there is no warranty for this free software. If the software is modified by someone else and passed on, we want its recipients to know that what they have is not the original, so that any problems introduced by others will not reflect on the original authors' reputations.

Finally, any free program is threatened constantly by software patents. We wish to avoid the danger that redistributors of a free program will individually obtain patent licenses, in effect making the program proprietary. To prevent this, we have made it clear that any patent must be licensed for everyone's free use or not licensed at all.

The precise terms and conditions for copying, distribution and modification follow.

#### GNU GENERAL PUBLIC LICENSE TERMS AND CONDITIONS FOR COPYING, DISTRIBUTION AND MODIFICATION

0. This License applies to any program or other work which contains a notice placed by the copyright holder saying it may be distributed under the terms of this General Public License. The ""Program"", below, refers to any such program or work, and a ""work based on the Program"" means either the Program or any derivative work under copyright law: that is to say, a work containing the Program or a portion of it, either verbatim or with modifications and/or translated into another language. (Hereinafter, translation is included without limitation in the term ""modification"". ) Each licensee is addressed as ""you"".

Activities other than copying, distribution and modification are not covered by this License; they are outside its scope. The act of running the Program is not restricted, and the output from the Program is covered only if its contents constitute a work based on the Program (independent of having been made by running the Program). Whether that is true depends on what the Program does.

1. You may copy and distribute verbatim copies of the Program's source code as you receive it, in any medium, provided that you conspicuously and appropriately publish on each copy an appropriate copyright notice and disclaimer of warranty; keep intact all the notices that refer to this License and to the absence of any warranty; and give any other recipients of the Program a copy of this License along with the Program.

You may charge a fee for the physical act of transferring a copy, and you may at your option offer warranty protection in exchange for a fee.

2. You may modify your copy or copies of the Program or any portion of it, thus forming a work based on the Program, and copy and distribute such modifications or work under the terms of Section 1 above, provided that you also meet all of these conditions:

- a) You must cause the modified files to carry prominent notices stating that you changed the files and the date of any change.

b) You must cause any work that you distribute or publish, that in whole or in part contains or is derived from the Program or any part thereof, to be licensed as a whole at no charge to all third parties under the terms of this License.

c) If the modified program normally reads commands interactively when run, you must cause it, when started running for such interactive use in the most ordinary way, to print or display an announcement including an appropriate copyright notice and a notice that there is no warranty (or else, saying that you provide a warranty) and that users may redistribute the program under these conditions, and telling the user how to view a copy of this License. (Exception: if the Program itself is interactive but does not normally print such an announcement, your work based on the Program is not required to print an announcement.)

These requirements apply to the modified work as a whole. If identifiable sections of that work are not derived from the Program, and can be reasonably considered independent and separate works in themselves, then this License, and its terms, do not apply to those sections when you distribute them as separate works. But when you distribute the same sections as part of a whole which is a work based on the Program, the distribution of the whole must be on the terms of this License, whose permissions for other licensees extend to the entire whole, and thus to each and every part regardless of who wrote it.

Thus, it is not the intent of this section to claim rights or contest your rights to work written entirely by you; rather, the intent is to exercise the right to control the distribution of derivative or collective works based on the Program.

In addition, mere aggregation of another work not based on the Program with the Program (or with a work based on the Program) on a volume of a storage or distribution medium does not bring the other work under the scope of this License.

3. You may copy and distribute the Program (or a work based on it, under Section 2) in object code or executable form under the terms of Sections 1 and 2 above provided that you also do one of the following:

a) Accompany it with the complete corresponding machine-readable source code, which must be distributed under the terms of Sections 1 and 2 above on a medium customarily used for software interchange; or,

b) Accompany it with a written offer, valid for at least three years, to give any third party, for a charge no more than your cost of physically performing source distribution, a complete machine-readable copy of the corresponding source code, to be distributed under the terms of Sections 1 and 2 above on a medium customarily used for software interchange; or,

c) Accompany it with the information you received as to the offer to distribute corresponding source code. (This alternative is allowed only for noncommercial distribution and only if you received the program in object code or executable form with such an offer, in accord with Subsection b above.)

The source code for a work means the preferred form of the work for making modifications to it. For an executable work, complete source code means all the source code for all modules it contains, plus any

associated interface definition files, plus the scripts used to control compilation and installation of the executable. However, as a special exception, the source code distributed need not include anything that is normally distributed (in either source or binary form) with the major components (compiler, kernel, and so on) of the operating system on which the executable runs, unless that component itself accompanies the executable.

If distribution of executable or object code is made by offering access to copy from a designated place, then offering equivalent access to copy the source code from the same place counts as distribution of the source code, even though third parties are not compelled to copy the source along with the object code.

4. You may not copy, modify, sublicense, or distribute the Program except as expressly provided under this License. Any attempt otherwise to copy, modify, sublicense or distribute the Program is void, and will automatically terminate your rights under this License. However, parties who have received copies, or rights, from you under this License will not have their licenses terminated so long as such parties remain in full compliance.

5. You are not required to accept this License, since you have not signed it. However, nothing else grants you permission to modify or distribute the Program or its derivative works. These actions are prohibited by law if you do not accept this License. Therefore, by modifying or distributing the Program (or any work based on the Program), you indicate your acceptance of this License to do so, and all its terms and conditions for copying, distributing or modifying the Program or works based on it.

6. Each time you redistribute the Program (or any work based on the Program), the recipient automatically receives a license from the original licensor to copy, distribute or modify the Program subject to these terms and conditions. You may not impose any further restrictions on the recipients' exercise of the rights granted herein. You are not responsible for enforcing compliance by third parties to this License.

7. If, as a consequence of a court judgment or allegation of patent infringement or for any other reason (not limited to patent issues), conditions are imposed on you (whether by court order, agreement or otherwise) that contradict the conditions of this License, they do not excuse you from the conditions of this License. If you cannot distribute so as to satisfy simultaneously your obligations under this License and any other pertinent obligations, then as a consequence you may not distribute the Program at all. For example, if a patent license would not permit royalty-free redistribution of the Program by all those who receive copies directly or indirectly through you, then the only way you could satisfy both it and this License would be to refrain entirely from distribution of the Program.

If any portion of this section is held invalid or unenforceable under any particular circumstance, the balance of the section is intended to apply and the section as a whole is intended to apply in other circumstances.

It is not the purpose of this section to induce you to infringe any patents or other property right claims or to contest validity of any such claims; this section has the sole purpose of protecting the

integrity of the free software distribution system, which is implemented by public license practices. Many people have made generous contributions to the wide range of software distributed through that system in reliance on consistent application of that system; it is up to the author/donor to decide if he or she is willing to distribute software through any other system and a licensee cannot impose that choice.

This section is intended to make thoroughly clear what is believed to be a consequence of the rest of this License.

8. If the distribution and/or use of the Program is restricted in certain countries either by patents or by copyrighted interfaces, the original copyright holder who places the Program under this License may add an explicit geographical distribution limitation excluding those countries, so that distribution is permitted only in or among countries not thus excluded. In such case, this License incorporates the limitation as if written in the body of this License.

9. The Free Software Foundation may publish revised and/or new versions of the General Public License from time to time. Such new versions will be similar in spirit to the present version, but may differ in detail to address new problems or concerns.

Each version is given a distinguishing version number. If the Program specifies a version number of this License which applies to it and "any later version", you have the option of following the terms and conditions either of that version or of any later version published by the Free Software Foundation. If the Program does not specify a version number of this License, you may choose any version ever published by the Free Software Foundation.

10. If you wish to incorporate parts of the Program into other free programs whose distribution conditions are different, write to the author to ask for permission. For software which is copyrighted by the Free Software Foundation, write to the Free Software Foundation; we sometimes make exceptions for this. Our decision will be guided by the two goals of preserving the free status of all derivatives of our free software and of promo"

---

u-boot

```
"# (C) Copyright 2000 - 2005
# Wolfgang Denk, DENX Software Engineering, wd@denx.de.
#
# See file CREDITS for list of people who contributed to this
# project.
#
# This program is free software; you can redistribute it and/or
# modify it under the terms of the GNU General Public License as
# published by the Free Software Foundation; either version 2 of
# the License, or (at your option) any later version.
#
# This program is distributed in the hope that it will be useful,
# but WITHOUT ANY WARRANTY; without even the implied warranty of
# MERCHANTABILITY or FITNESS FOR A PARTICULAR PURPOSE.
See the
# GNU General Public License for more details.
#
# You should have received a copy of the GNU General Public License
# along with this program; if not, write to the Free Software
# Foundation, Inc., 59 Temple Place, Suite 330, Boston,
```

	# MA 02111-1307 USA "
firewall	/* * firewall3 - 3rd OpenWrt UCI firewall implementation * * Copyright (C) 2013-2014 Jo-Philipp Wich <jow@openwrt.org> * * Permission to use, copy, modify, and/or distribute this software for any * purpose with or without fee is hereby granted, provided that the above * copyright notice and this permission notice appear in all copies. * * THE SOFTWARE IS PROVIDED "AS IS" AND THE AUTHOR DISCLAIMS ALL WARRANTIES * WITH REGARD TO THIS SOFTWARE INCLUDING ALL IMPLIED WARRANTIES OF * MERCHANTABILITY AND FITNESS. IN NO EVENT SHALL THE AUTHOR BE LIABLE FOR * ANY SPECIAL, DIRECT, INDIRECT, OR CONSEQUENTIAL DAMAGES OR ANY DAMAGES * WHATSOEVER RESULTING FROM LOSS OF USE, DATA OR PROFITS, WHETHER IN AN * ACTION OF CONTRACT, NEGLIGENCE OR OTHER TORTIOUS ACTION, ARISING OUT OF * OR IN CONNECTION WITH THE USE OR PERFORMANCE OF THIS SOFTWARE. */
fstools	/* * Copyright (C) 2014 John Crispin <blogic@openwrt.org> * * This program is free software; you can redistribute it and/or modify * it under the terms of the GNU Lesser General Public License version 2.1 * as published by the Free Software Foundation * * This program is distributed in the hope that it will be useful, * but WITHOUT ANY WARRANTY; without even the implied warranty of * MERCHANTABILITY or FITNESS FOR A PARTICULAR PURPOSE. See the * GNU General Public License for more details. */
iputils	/* * Copyright (c) 1989 The Regents of the University of California. * All rights reserved. * * This code is derived from software contributed to Berkeley by * Mike Muuss. * * Redistribution and use in source and binary forms, with or without * modification, are permitted provided that the following conditions * are met: * 1. Redistributions of source code must retain the above copyright * notice, this list of conditions and the following disclaimer. * 2. Redistributions in binary form must reproduce the above copyright * notice, this list of conditions and the following disclaimer in the * documentation and/or other materials provided with the distribution. * 3. All advertising materials mentioning features or use of this software * must display the following acknowledgement: * This product includes software developed by the University of

```

* California, Berkeley and its contributors.
* 4. Neither the name of the University nor the names of its contributors
* may be used to endorse or promote products derived from this software
* without specific prior written permission.
*
* THIS SOFTWARE IS PROVIDED BY THE REGENTS AND
CONTRIBUTORS ``AS IS" AND
* ANY EXPRESS OR IMPLIED WARRANTIES, INCLUDING, BUT NOT
LIMITED TO, THE
* IMPLIED WARRANTIES OF MERCHANTABILITY AND FITNESS FOR A
PARTICULAR PURPOSE
* ARE DISCLAIMED. IN NO EVENT SHALL THE REGENTS OR
CONTRIBUTORS BE LIABLE
* FOR ANY DIRECT, INDIRECT, INCIDENTAL, SPECIAL, EXEMPLARY, OR
CONSEQUENTIAL
* DAMAGES (INCLUDING, BUT NOT LIMITED TO, PROCUREMENT OF
SUBSTITUTE GOODS
* OR SERVICES; LOSS OF USE, DATA, OR PROFITS; OR BUSINESS
INTERRUPTION)
* HOWEVER CAUSED AND ON ANY THEORY OF LIABILITY, WHETHER IN
CONTRACT, STRICT
* LIABILITY, OR TORT (INCLUDING NEGLIGENCE OR OTHERWISE)
ARISING IN ANY WAY
* OUT OF THE USE OF THIS SOFTWARE, EVEN IF ADVISED OF THE
POSSIBILITY OF
* SUCH DAMAGE.
*/
/*
*
* Modified for AF_INET6 by Pedro Roque
*
* <roque@di.fc.ul.pt>
*
* Original copyright notice included bellow
*/
/*
* Copyright (c) 1989 The Regents of the University of California.
* All rights reserved.
*
* This code is derived from software contributed to Berkeley by
* Mike Muuss.
*
* Redistribution and use in source and binary forms, with or without
* modification, are permitted provided that the following conditions
* are met:
* 1. Redistributions of source code must retain the above copyright
* notice, this list of conditions and the following disclaimer.
* 2. Redistributions in binary form must reproduce the above copyright
* notice, this list of conditions and the following disclaimer in the
* documentation and/or other materials provided with the distribution.
* 3. All advertising materials mentioning features or use of this software
* must display the following acknowledgement:
* This product includes software developed by the University of
* California, Berkeley and its contributors.
* 4. Neither the name of the University nor the names of its contributors
* may be used to endorse or promote products derived from this software
* without specific prior written permission.
*
* THIS SOFTWARE IS PROVIDED BY THE REGENTS AND

```

	<p>CONTRIBUTORS "AS IS" AND</p> <ul style="list-style-type: none"> <li>* ANY EXPRESS OR IMPLIED WARRANTIES, INCLUDING, BUT NOT LIMITED TO, THE</li> <li>* IMPLIED WARRANTIES OF MERCHANTABILITY AND FITNESS FOR A PARTICULAR PURPOSE</li> <li>* ARE DISCLAIMED. IN NO EVENT SHALL THE REGENTS OR CONTRIBUTORS BE LIABLE</li> <li>* FOR ANY DIRECT, INDIRECT, INCIDENTAL, SPECIAL, EXEMPLARY, OR CONSEQUENTIAL</li> <li>* DAMAGES (INCLUDING, BUT NOT LIMITED TO, PROCUREMENT OF SUBSTITUTE GOODS</li> <li>* OR SERVICES; LOSS OF USE, DATA, OR PROFITS; OR BUSINESS INTERRUPTION)</li> <li>* HOWEVER CAUSED AND ON ANY THEORY OF LIABILITY, WHETHER IN CONTRACT, STRICT</li> <li>* LIABILITY, OR TORT (INCLUDING NEGLIGENCE OR OTHERWISE) ARISING IN ANY WAY</li> <li>* OUT OF THE USE OF THIS SOFTWARE, EVEN IF ADVISED OF THE POSSIBILITY OF</li> <li>* SUCH DAMAGE.</li> <li>*/</li> </ul>
jsonfilter	<p>/*</p> <ul style="list-style-type: none"> <li>* Copyright (C) 2013-2014 Jo-Philipp Wich &lt;jow@openwrt.org&gt;</li> <li>*</li> <li>* Permission to use, copy, modify, and/or distribute this software for any</li> <li>* purpose with or without fee is hereby granted, provided that the above</li> <li>* copyright notice and this permission notice appear in all copies.</li> <li>*</li> <li>* THE SOFTWARE IS PROVIDED "AS IS" AND THE AUTHOR DISCLAIMS ALL WARRANTIES</li> <li>* WITH REGARD TO THIS SOFTWARE INCLUDING ALL IMPLIED WARRANTIES OF</li> <li>* MERCHANTABILITY AND FITNESS. IN NO EVENT SHALL THE AUTHOR BE LIABLE FOR</li> <li>* ANY SPECIAL, DIRECT, INDIRECT, OR CONSEQUENTIAL DAMAGES OR ANY DAMAGES</li> <li>* WHATSOEVER RESULTING FROM LOSS OF USE, DATA OR PROFITS, WHETHER IN AN</li> <li>* ACTION OF CONTRACT, NEGLIGENCE OR OTHER TORTIOUS ACTION, ARISING OUT OF</li> <li>* OR IN CONNECTION WITH THE USE OR PERFORMANCE OF THIS SOFTWARE.</li> <li>*/</li> </ul>
klish	<p>Overview</p> <p>This package contains code which is copyrighted to multiple sources.</p> <p>=====</p> <p>3Com Corporation</p> <p>The initial public release of this software was developed by Graeme McKerrill whilst in the employment of 3Com Europe Ltd.</p> <p>Copyright (c) 2005, 3Com Corporation</p> <p>All rights reserved.</p> <p>Redistribution and use in source and binary forms, with or without modification, are permitted provided that the following conditions are met:</p>



- \* Redistributions of source code must retain the above copyright notice, this list of conditions and the following disclaimer.
- \* Redistributions in binary form must reproduce the above copyright notice, this list of conditions and the following disclaimer in the documentation and/or other materials provided with the distribution.
- \* Neither the name of 3Com Corporation nor the names of its contributors may be used to endorse or promote products derived from this software without specific prior written permission.

THIS SOFTWARE IS PROVIDED BY THE COPYRIGHT HOLDERS AND CONTRIBUTORS "AS IS" AND ANY EXPRESS OR IMPLIED WARRANTIES, INCLUDING, BUT NOT LIMITED TO, THE IMPLIED WARRANTIES OF MERCHANTABILITY AND FITNESS FOR A PARTICULAR PURPOSE ARE DISCLAIMED. IN NO EVENT SHALL THE COPYRIGHT OWNER OR CONTRIBUTORS BE LIABLE FOR ANY DIRECT, INDIRECT, INCIDENTAL, SPECIAL, EXEMPLARY, OR CONSEQUENTIAL DAMAGES (INCLUDING, BUT NOT LIMITED TO, PROCUREMENT OF SUBSTITUTE GOODS OR SERVICES; LOSS OF USE, DATA, OR PROFITS; OR BUSINESS INTERRUPTION) HOWEVER CAUSED AND ON ANY THEORY OF LIABILITY, WHETHER IN CONTRACT, STRICT LIABILITY, OR TORT (INCLUDING NEGLIGENCE OR OTHERWISE) ARISING IN ANY WAY OUT OF THE USE OF THIS SOFTWARE, EVEN IF ADVISED OF THE POSSIBILITY OF SUCH DAMAGE.

=====  
=====

Newport Networks Ltd.  
The 0.6-0.7 releases of this software was developed by Graeme McKerrell whilst in the employment of Newport Networks Ltd.  
As well as enhancing the existing code the new modules were developed.

Copyright (c) 2005,2006, Newport Networks Ltd  
All rights reserved.

Redistribution and use in source and binary forms, with or without modification, are permitted provided that the following conditions are met:

- \* Redistributions of source code must retain the above copyright notice, this list of conditions and the following disclaimer.
- \* Redistributions in binary form must reproduce the above copyright notice, this list of conditions and the following disclaimer in the documentation and/or other materials provided with the distribution.
- \* Neither the name of Newport Networks Ltd nor the names of its contributors may be used to endorse or promote products derived from this software without specific prior written permission.

THIS SOFTWARE IS PROVIDED BY THE COPYRIGHT HOLDERS AND CONTRIBUTORS "AS IS" AND ANY EXPRESS OR IMPLIED WARRANTIES, INCLUDING, BUT NOT LIMITED TO, THE IMPLIED WARRANTIES OF MERCHANTABILITY AND FITNESS FOR A PARTICULAR PURPOSE ARE

DISCLAIMED. IN NO EVENT SHALL THE COPYRIGHT OWNER OR CONTRIBUTORS BE LIABLE FOR ANY DIRECT, INDIRECT, INCIDENTAL, SPECIAL, EXEMPLARY, OR CONSEQUENTIAL DAMAGES (INCLUDING, BUT NOT LIMITED TO, PROCUREMENT OF SUBSTITUTE GOODS OR SERVICES; LOSS OF USE, DATA, OR PROFITS; OR BUSINESS INTERRUPTION) HOWEVER CAUSED AND ON ANY THEORY OF LIABILITY, WHETHER IN CONTRACT, STRICT LIABILITY, OR TORT (INCLUDING NEGLIGENCE OR OTHERWISE) ARISING IN ANY WAY OUT OF THE USE OF THIS SOFTWARE, EVEN IF ADVISED OF THE POSSIBILITY OF SUCH DAMAGE.

=====  
=====

Serj Kalichev  
The klish is a fork of original clish.

Copyright (c) 2010 Serj Kalichev.  
All Rights Reserved.

Redistribution and use in source and binary forms, with or without modification, are permitted provided that the following conditions are met:

1. Redistributions of source code must retain the above copyright notice, this list of conditions and the following disclaimer.
2. Redistributions in binary form must reproduce the above copyright notice, this list of conditions and the following disclaimer in the documentation and/or other materials provided with the distribution.
3. The name of the author may not be used to endorse or promote products derived from this software without specific prior written permission.

THIS SOFTWARE IS PROVIDED BY THE COPYRIGHT HOLDERS AND CONTRIBUTORS "AS IS" AND ANY EXPRESS OR IMPLIED WARRANTIES, INCLUDING, BUT NOT LIMITED TO, THE IMPLIED WARRANTIES OF MERCHANTABILITY AND FITNESS FOR A PARTICULAR PURPOSE ARE DISCLAIMED. IN NO EVENT SHALL THE COPYRIGHT OWNER OR CONTRIBUTORS BE LIABLE FOR ANY DIRECT, INDIRECT, INCIDENTAL, SPECIAL, EXEMPLARY, OR CONSEQUENTIAL DAMAGES (INCLUDING, BUT NOT LIMITED TO, PROCUREMENT OF SUBSTITUTE GOODS OR SERVICES; LOSS OF USE, DATA, OR PROFITS; OR BUSINESS INTERRUPTION) HOWEVER CAUSED AND ON ANY THEORY OF LIABILITY, WHETHER IN CONTRACT, STRICT LIABILITY, OR TORT (INCLUDING NEGLIGENCE OR OTHERWISE) ARISING IN ANY WAY OUT OF THE USE OF THIS SOFTWARE, EVEN IF ADVISED OF THE POSSIBILITY OF SUCH DAMAGE.

librpc

/\*  
\* Sun RPC is a product of Sun Microsystems, Inc. and is provided for  
\* unrestricted use provided that this legend is included on all tape  
\* media and as a part of the software program in whole or part. Users

	<p>* may copy or modify Sun RPC without charge, but are not authorized  * to license or distribute it to anyone else except as part of a product or  * program developed by the user.  *  * SUN RPC IS PROVIDED AS IS WITH NO WARRANTIES OF ANY KIND  INCLUDING THE  * WARRANTIES OF DESIGN, MERCHANTABILITY AND FITNESS FOR A  PARTICULAR  * PURPOSE, OR ARISING FROM A COURSE OF DEALING, USAGE OR  TRADE PRACTICE.  *  * Sun RPC is provided with no support and without any obligation on the  * part of Sun Microsystems, Inc. to assist in its use, correction,  * modification or enhancement.  *  * SUN MICROSYSTEMS, INC. SHALL HAVE NO LIABILITY WITH RESPECT  TO THE  * INFRINGEMENT OF COPYRIGHTS, TRADE SECRETS OR ANY  PATENTS BY SUN RPC  * OR ANY PART THEREOF.  *  * In no event will Sun Microsystems, Inc. be liable for any lost revenue  * or profits or other special, indirect and consequential damages, even if  * Sun has been advised of the possibility of such damages.  *  * Sun Microsystems, Inc.  * 2550 Garcia Avenue  * Mountain View, California 94043  */  /*  * Copyright (C) 1984, Sun Microsystems, Inc.  */</p>
libubox	<p>/*  * Copyright (C) 2010-2012 Felix Fietkau &lt;nbd@openwrt.org&gt;  *  * Permission to use, copy, modify, and/or distribute this software for any  * purpose with or without fee is hereby granted, provided that the above  * copyright notice and this permission notice appear in all copies.  *  * THE SOFTWARE IS PROVIDED "AS IS" AND THE AUTHOR DISCLAIMS  ALL WARRANTIES  * WITH REGARD TO THIS SOFTWARE INCLUDING ALL IMPLIED  WARRANTIES OF  * MERCHANTABILITY AND FITNESS. IN NO EVENT SHALL THE AUTHOR  BE LIABLE FOR  * ANY SPECIAL, DIRECT, INDIRECT, OR CONSEQUENTIAL DAMAGES OR  ANY DAMAGES  * WHATSOEVER RESULTING FROM LOSS OF USE, DATA OR PROFITS,  WHETHER IN AN  * ACTION OF CONTRACT, NEGLIGENCE OR OTHER TORTIOUS ACTION,  ARISING OUT OF  * OR IN CONNECTION WITH THE USE OR PERFORMANCE OF THIS  SOFTWARE.  */</p>
lua	<p>Lua License  -----    Lua is licensed under the terms of the MIT license reproduced below.  This means that Lua is free software and can be used for both academic</p>

and commercial purposes at absolutely no cost.

For details and rationale, see <http://www.lua.org/license.html> .

=====  
=====

Copyright (C) 1994-2012 Lua.org, PUC-Rio.

Permission is hereby granted, free of charge, to any person obtaining a copy of this software and associated documentation files (the "Software"), to deal in the Software without restriction, including without limitation the rights to use, copy, modify, merge, publish, distribute, sublicense, and/or sell copies of the Software, and to permit persons to whom the Software is furnished to do so, subject to the following conditions:

The above copyright notice and this permission notice shall be included in all copies or substantial portions of the Software.

THE SOFTWARE IS PROVIDED "AS IS", WITHOUT WARRANTY OF ANY KIND, EXPRESS OR IMPLIED, INCLUDING BUT NOT LIMITED TO THE WARRANTIES OF MERCHANTABILITY, FITNESS FOR A PARTICULAR PURPOSE AND NONINFRINGEMENT. IN NO EVENT SHALL THE AUTHORS OR COPYRIGHT HOLDERS BE LIABLE FOR ANY CLAIM, DAMAGES OR OTHER LIABILITY, WHETHER IN AN ACTION OF CONTRACT, TORT OR OTHERWISE, ARISING FROM, OUT OF OR IN CONNECTION WITH THE SOFTWARE OR THE USE OR OTHER DEALINGS IN THE SOFTWARE.

=====  
=====

(end of COPYRIGHT)

LuaSrcDiet

LuaSrcDiet License

-----

LuaSrcDiet is licensed under the terms of the MIT license reproduced below. This means that LuaSrcDiet is free software and can be used for both academic and commercial purposes at absolutely no cost.

Think of LuaSrcDiet as a compiler or a text filter; whatever that is processed by LuaSrcDiet is not affected by its license. It does not add anything new into your source code; it only transforms code that already exist.

Hence, there is no need to tag this license onto Lua programs that are only processed. Given the liberal terms of this kind of license, the primary purpose is just to claim authorship of LuaSrcDiet.

Parts of LuaSrcDiet is based on Lua 5 code. See the file COPYRIGHT\_Lua51 (Lua 5.1.4) for Lua 5's license.

=====  
=====

Copyright (C) 2005-2008,2011 Kein-Hong Man <keinhong@gmail.com>

Lua 5.1.4 Copyright (C) 1994-2008 Lua.org, PUC-Rio.

Permission is hereby granted, free of charge, to any person obtaining a copy of this software and associated documentation files (the "Software"), to deal in the Software without restriction, including without limitation the rights to use, copy, modify, merge, publish, distribute, sublicense, and/or sell copies of the Software, and to permit persons to whom the Software is furnished to do so, subject to the following conditions:

The above copyright notice and this permission notice shall be included in all copies or substantial portions of the Software.

THE SOFTWARE IS PROVIDED "AS IS", WITHOUT WARRANTY OF ANY KIND, EXPRESS OR IMPLIED, INCLUDING BUT NOT LIMITED TO THE WARRANTIES OF MERCHANTABILITY, FITNESS FOR A PARTICULAR PURPOSE AND NONINFRINGEMENT. IN NO EVENT SHALL THE AUTHORS OR COPYRIGHT HOLDERS BE LIABLE FOR ANY CLAIM, DAMAGES OR OTHER LIABILITY, WHETHER IN AN ACTION OF CONTRACT, TORT OR OTHERWISE, ARISING FROM, OUT OF OR IN CONNECTION WITH THE SOFTWARE OR THE USE OR OTHER DEALINGS IN THE SOFTWARE.

=====  
=====

(end of COPYRIGHT)

lzma

LZMA SDK 4.65

-----

LZMA SDK provides the documentation, samples, header files, libraries, and tools you need to develop applications that use LZMA compression.

LZMA is default and general compression method of 7z format in 7-Zip compression program ([www.7-zip.org](http://www.7-zip.org)). LZMA provides high compression ratio and very fast decompression.

LZMA is an improved version of famous LZ77 compression algorithm. It was improved in way of maximum increasing of compression ratio, keeping high decompression speed and low memory requirements for decompressing.

LICENSE

-----

LZMA SDK is written and placed in the public domain by Igor Pavlov.

LZMA SDK Contents

-----

LZMA SDK includes:

- ANSI-C/C++/C#/Java source code for LZMA compressing and decompressing

	- Compiled file->file LZMA compressing/decompressing program for Windows system
nat46	<pre> * Copyright (c) 2013-2014 Andrew Yourtchenko &lt;ayourtch@gmail.com&gt; * * This program is free software; you can redistribute it and/or modify * it under the terms of the GNU General Public License version 2 * as published by the Free Software Foundation * * This program is distributed in the hope that it will be useful, * but WITHOUT ANY WARRANTY; without even the implied warranty of * MERCHANTABILITY or FITNESS FOR A PARTICULAR PURPOSE. See the * GNU General Public License for more details. </pre>
netifd	<pre> /* * netifd - network interface daemon * Copyright (C) 2012 Felix Fietkau &lt;nbd@openwrt.org&gt; * * This program is free software; you can redistribute it and/or modify * it under the terms of the GNU General Public License version 2 * as published by the Free Software Foundation * * This program is distributed in the hope that it will be useful, * but WITHOUT ANY WARRANTY; without even the implied warranty of * MERCHANTABILITY or FITNESS FOR A PARTICULAR PURPOSE. See the * GNU General Public License for more details. */ </pre>
procd	<pre> /* * Copyright (C) 2013 Felix Fietkau &lt;nbd@openwrt.org&gt; * Copyright (C) 2013 John Crispin &lt;blogic@openwrt.org&gt; * * This program is free software; you can redistribute it and/or modify * it under the terms of the GNU Lesser General Public License version 2.1 * as published by the Free Software Foundation * * This program is distributed in the hope that it will be useful, * but WITHOUT ANY WARRANTY; without even the implied warranty of * MERCHANTABILITY or FITNESS FOR A PARTICULAR PURPOSE. See the * GNU General Public License for more details. */ </pre>
rpcd	<pre> /* * rpcd - UBUS RPC server * * Copyright (C) 2013 Felix Fietkau &lt;nbd@openwrt.org&gt; * Copyright (C) 2013-2014 Jo-Philipp Wich &lt;jow@openwrt.org&gt; * * Permission to use, copy, modify, and/or distribute this software for any * purpose with or without fee is hereby granted, provided that the above * copyright notice and this permission notice appear in all copies. * * THE SOFTWARE IS PROVIDED "AS IS" AND THE AUTHOR DISCLAIMS ALL WARRANTIES * WITH REGARD TO THIS SOFTWARE INCLUDING ALL IMPLIED WARRANTIES OF * MERCHANTABILITY AND FITNESS. IN NO EVENT SHALL THE AUTHOR BE LIABLE FOR </pre>

	<p>* ANY SPECIAL, DIRECT, INDIRECT, OR CONSEQUENTIAL DAMAGES OR ANY DAMAGES  * WHATSOEVER RESULTING FROM LOSS OF USE, DATA OR PROFITS, WHETHER IN AN  * ACTION OF CONTRACT, NEGLIGENCE OR OTHER TORTIOUS ACTION, ARISING OUT OF  * OR IN CONNECTION WITH THE USE OR PERFORMANCE OF THIS SOFTWARE.  */</p>
ubox	<p>/*  * Copyright (C) 2013 Felix Fietkau &lt;nbd@openwrt.org&gt;  * Copyright (C) 2013 John Crispin &lt;blogic@openwrt.org&gt;  *  * This program is free software; you can redistribute it and/or modify  * it under the terms of the GNU Lesser General Public License version 2.1  * as published by the Free Software Foundation  *  * This program is distributed in the hope that it will be useful,  * but WITHOUT ANY WARRANTY; without even the implied warranty of  * MERCHANTABILITY or FITNESS FOR A PARTICULAR PURPOSE. See  the  * GNU General Public License for more details.  */</p>
ubus	<p>/*  * Copyright (C) 2011-2014 Felix Fietkau &lt;nbd@openwrt.org&gt;  *  * This program is free software; you can redistribute it and/or modify  * it under the terms of the GNU Lesser General Public License version 2.1  * as published by the Free Software Foundation  *  * This program is distributed in the hope that it will be useful,  * but WITHOUT ANY WARRANTY; without even the implied warranty of  * MERCHANTABILITY or FITNESS FOR A PARTICULAR PURPOSE. See  the  * GNU General Public License for more details.  */</p>
uci	<p>/*  * libuci - Library for the Unified Configuration Interface  * Copyright (C) 2008 Felix Fietkau &lt;nbd@openwrt.org&gt;  *  * This program is free software; you can redistribute it and/or modify  * it under the terms of the GNU Lesser General Public License version 2.1  * as published by the Free Software Foundation  *  * This program is distributed in the hope that it will be useful,  * but WITHOUT ANY WARRANTY; without even the implied warranty of  * MERCHANTABILITY or FITNESS FOR A PARTICULAR PURPOSE. See  the  * GNU Lesser General Public License for more details.  */</p>
uClibc++	<p>/* Copyright (C) 2004 Garrett A. Kajmowicz  This file is part of the uClibc++ Library.   This library is free software; you can redistribute it and/or modify it under the terms of the GNU Lesser General Public License as published by the Free Software Foundation; either version 2.1 of the License, or (at your option) any later version.</p>

	<p>This library is distributed in the hope that it will be useful, but WITHOUT ANY WARRANTY; without even the implied warranty of MERCHANTABILITY or FITNESS FOR A PARTICULAR PURPOSE. See the GNU Lesser General Public License for more details.</p> <p>You should have received a copy of the GNU Lesser General Public License along with this library; if not, write to the Free Software Foundation, Inc., 59 Temple Place, Suite 330, Boston, MA 02111-1307 USA</p> <p>*/</p>
uhttpd	<pre>/*  * uhttpd - Tiny single-threaded httpd  *  * Copyright (C) 2010-2013 Jo-Philipp Wich &lt;xm@subsignal.org&gt;  * Copyright (C) 2013 Felix Fietkau &lt;nbd@openwrt.org&gt;  *  * Permission to use, copy, modify, and/or distribute this software for any  * purpose with or without fee is hereby granted, provided that the above  * copyright notice and this permission notice appear in all copies.  *  * THE SOFTWARE IS PROVIDED "AS IS" AND THE AUTHOR DISCLAIMS  * ALL WARRANTIES  * WITH REGARD TO THIS SOFTWARE INCLUDING ALL IMPLIED  * WARRANTIES OF  * MERCHANTABILITY AND FITNESS. IN NO EVENT SHALL THE AUTHOR  * BE LIABLE FOR  * ANY SPECIAL, DIRECT, INDIRECT, OR CONSEQUENTIAL DAMAGES OR  * ANY DAMAGES  * WHATSOEVER RESULTING FROM LOSS OF USE, DATA OR PROFITS,  * WHETHER IN AN  * ACTION OF CONTRACT, NEGLIGENCE OR OTHER TORTIOUS ACTION,  * ARISING OUT OF  * OR IN CONNECTION WITH THE USE OR PERFORMANCE OF THIS  * SOFTWARE.  */</pre>
usign	<pre>/*  * usign - tiny signify replacement  *  * Copyright (C) 2015 Felix Fietkau &lt;nbd@openwrt.org&gt;  *  * Permission to use, copy, modify, and/or distribute this software for any  * purpose with or without fee is hereby granted, provided that the above  * copyright notice and this permission notice appear in all copies.  *  * THE SOFTWARE IS PROVIDED "AS IS" AND THE AUTHOR DISCLAIMS  * ALL WARRANTIES  * WITH REGARD TO THIS SOFTWARE INCLUDING ALL IMPLIED  * WARRANTIES OF  * MERCHANTABILITY AND FITNESS. IN NO EVENT SHALL THE AUTHOR  * BE LIABLE FOR  * ANY SPECIAL, DIRECT, INDIRECT, OR CONSEQUENTIAL DAMAGES OR  * ANY DAMAGES  * WHATSOEVER RESULTING FROM LOSS OF USE, DATA OR PROFITS,  * WHETHER IN AN  * ACTION OF CONTRACT, NEGLIGENCE OR OTHER TORTIOUS ACTION,  * ARISING OUT OF  * OR IN CONNECTION WITH THE USE OR PERFORMANCE OF THIS</pre>



	<pre>SOFTWARE. */</pre>
attr	<pre>/*  * Copyright (c) 2001-2003,2005 Silicon Graphics, Inc.  * All Rights Reserved.  *  * This program is free software: you can redistribute it and/or modify it  * under the terms of the GNU Lesser General Public License as published  * by the Free Software Foundation, either version 2.1 of the License, or  * (at your option) any later version.  *  * This program is distributed in the hope that it will be useful,  * but WITHOUT ANY WARRANTY; without even the implied warranty of  * MERCHANTABILITY or FITNESS FOR A PARTICULAR PURPOSE. See the  * GNU Lesser General Public License for more details.  *  * You should have received a copy of the GNU Lesser General Public License  * along with this program. If not, see &lt;http://www.gnu.org/licenses/&gt;. */</pre>
bc	<pre>/* A Bison parser, made by GNU Bison 2.1. */  /* Skeleton parser for Yacc-like parsing with Bison,    Copyright (C) 1984, 1989, 1990, 2000, 2001, 2002, 2003, 2004, 2005 Free    Software Foundation, Inc.     This program is free software; you can redistribute it and/or modify    it under the terms of the GNU General Public License as published by    the Free Software Foundation; either version 2, or (at your option)    any later version.     This program is distributed in the hope that it will be useful,    but WITHOUT ANY WARRANTY; without even the implied warranty of    MERCHANTABILITY or FITNESS FOR A PARTICULAR PURPOSE. See the    GNU General Public License for more details.     You should have received a copy of the GNU General Public License    along with this program; if not, write to the Free Software    Foundation, Inc., 51 Franklin Street, Fifth Floor,    Boston, MA 02110-1301, USA. */  /* As a special exception, when this file is copied by Bison into a    Bison output file, you may use that output file without restriction.    This special exception was added by the Free Software Foundation    in version 1.24 of Bison. */  /* Written by Richard Stallman by simplifying the original so called    ``semantic" parser. */  /* All symbols defined below should begin with yy or YY, to avoid    infringing on user name space. This should be done even for local    variables, as they might otherwise be expanded by user macros.    There are some unavoidable exceptions within include files to    define necessary library symbols; they are noted "INFRINGES ON    USER NAME SPACE" below. */</pre>

bridge-utils	<pre> /*  * Copyright (C) 2000 Lennert Buytenhek  *  * This program is free software; you can redistribute it and/or  * modify it under the terms of the GNU General Public License as  * published by the Free Software Foundation; either version 2 of the  * License, or (at your option) any later version.  *  * This program is distributed in the hope that it will be useful, but  * WITHOUT ANY WARRANTY; without even the implied warranty of  * MERCHANTABILITY or FITNESS FOR A PARTICULAR PURPOSE. See  * the GNU  * General Public License for more details.  *  * You should have received a copy of the GNU General Public License  * along with this program; if not, write to the Free Software  * Foundation, Inc., 675 Mass Ave, Cambridge, MA 02139, USA.  */ </pre>
busybox	<p>BusyBox is distributed under version 2 of the General Public License (included in its entirety, below). Version 2 is the only version of this license which this version of BusyBox (or modified versions derived from this one) may be distributed under.</p> <p>-----</p> <p style="text-align: center;">GNU GENERAL PUBLIC LICENSE Version 2, June 1991</p> <p>Copyright (C) 1989, 1991 Free Software Foundation, Inc. 51 Franklin St, Fifth Floor, Boston, MA 02110-1301 USA Everyone is permitted to copy and distribute verbatim copies of this license document, but changing it is not allowed.</p>
bzip2	<p>This program, "bzip2", the associated library "libbzip2", and all documentation, are copyright (C) 1996-2010 Julian R Seward. All rights reserved.</p> <p>Redistribution and use in source and binary forms, with or without modification, are permitted provided that the following conditions are met:</p> <ol style="list-style-type: none"> <li>1. Redistributions of source code must retain the above copyright notice, this list of conditions and the following disclaimer.</li> <li>2. The origin of this software must not be misrepresented; you must not claim that you wrote the original software. If you use this software in a product, an acknowledgment in the product documentation would be appreciated but is not required.</li> <li>3. Altered source versions must be plainly marked as such, and must not be misrepresented as being the original software.</li> <li>4. The name of the author may not be used to endorse or promote products derived from this software without specific prior written permission.</li> </ol> <p>THIS SOFTWARE IS PROVIDED BY THE AUTHOR ``AS IS'' AND ANY EXPRESS OR IMPLIED WARRANTIES, INCLUDING, BUT NOT LIMITED TO, THE IMPLIED WARRANTIES OF MERCHANTABILITY AND FITNESS FOR A PARTICULAR</p>

	<p>PURPOSE  ARE DISCLAIMED. IN NO EVENT SHALL THE AUTHOR BE LIABLE FOR  ANY  DIRECT, INDIRECT, INCIDENTAL, SPECIAL, EXEMPLARY, OR  CONSEQUENTIAL  DAMAGES (INCLUDING, BUT NOT LIMITED TO, PROCUREMENT OF  SUBSTITUTE  GOODS OR SERVICES; LOSS OF USE, DATA, OR PROFITS; OR  BUSINESS  INTERRUPTION) HOWEVER CAUSED AND ON ANY THEORY OF  LIABILITY,  WHETHER IN CONTRACT, STRICT LIABILITY, OR TORT (INCLUDING  NEGLIGENCE OR OTHERWISE) ARISING IN ANY WAY OUT OF THE USE  OF THIS  SOFTWARE, EVEN IF ADVISED OF THE POSSIBILITY OF SUCH DAMAGE.</p> <p>Julian Seward, jseward@bzip.org  bzip2/libbzip2 version 1.0.6 of 6 September 2010</p>
conntrack-tools	<pre>/*  * (C) 2006-2012 by Pablo Neira Ayuso &lt;pablo@netfilter.org&gt;  * (C) 2011-2012 by Vyatta Inc &lt;http://www.vyatta.com&gt;  *  * This program is free software; you can redistribute it and/or modify  * it under the terms of the GNU General Public License as published by  * the Free Software Foundation; either version 2 of the License, or  * (at your option) any later version.  *  * This program is distributed in the hope that it will be useful,  * but WITHOUT ANY WARRANTY; without even the implied warranty of  * MERCHANTABILITY or FITNESS FOR A PARTICULAR PURPOSE. See  * the  * GNU General Public License for more details.  *  * You should have received a copy of the GNU General Public License  * along with this program; if not, write to the Free Software  * Foundation, Inc., 675 Mass Ave, Cambridge, MA 02139, USA.  */</pre>
curl	<p>COPYRIGHT AND PERMISSION NOTICE</p> <p>Copyright (c) 1996 - 2015, Daniel Stenberg, &lt;daniel@haxx.se&gt;.</p> <p>All rights reserved.</p> <p>Permission to use, copy, modify, and distribute this software for any purpose with or without fee is hereby granted, provided that the above copyright notice and this permission notice appear in all copies.</p> <p>THE SOFTWARE IS PROVIDED "AS IS", WITHOUT WARRANTY OF ANY KIND, EXPRESS OR IMPLIED, INCLUDING BUT NOT LIMITED TO THE WARRANTIES OF MERCHANTABILITY, FITNESS FOR A PARTICULAR PURPOSE AND NONINFRINGEMENT OF THIRD PARTY RIGHTS. IN NO EVENT SHALL THE AUTHORS OR COPYRIGHT HOLDERS BE LIABLE FOR ANY CLAIM, DAMAGES OR OTHER LIABILITY, WHETHER IN AN ACTION OF CONTRACT, TORT OR OTHERWISE, ARISING FROM, OUT OF OR IN CONNECTION WITH THE SOFTWARE OR THE USE</p>

	<p>OR OTHER DEALINGS IN THE SOFTWARE.</p> <p>Except as contained in this notice, the name of a copyright holder shall not be used in advertising or otherwise to promote the sale, use or other dealings in this Software without prior written authorization of the copyright holder.</p>
device-agent	<pre> /* ===== ===== Name      : common.c Author    : Subi S S Version   : Copyright : Copyright (C) 2013 Cambium Networks, Ltd. All Rights Reserved CAMBIUM NETWORKS CONFIDENTIAL PROPRIETARY  Description : Functions which are useful for all platforms.  ===== ===== */ </pre>
dnsmasq	<pre> /* dnsmasq is Copyright (c) 2000-2015 Simon Kelley  This program is free software; you can redistribute it and/or modify it under the terms of the GNU General Public License as published by the Free Software Foundation; version 2 dated June, 1991, or (at your option) version 3 dated 29 June, 2007.  This program is distributed in the hope that it will be useful, but WITHOUT ANY WARRANTY; without even the implied warranty of MERCHANTABILITY or FITNESS FOR A PARTICULAR PURPOSE. See the GNU General Public License for more details.  You should have received a copy of the GNU General Public License along with this program. If not, see &lt;http://www.gnu.org/licenses/&gt;. */ </pre>
dropbear	<p>Dropbear contains a number of components from different sources, hence there are a few licenses and authors involved. All licenses are fairly non-restrictive.</p> <p>The majority of code is written by Matt Johnston, under the license below.</p> <p>Portions of the client-mode work are (c) 2004 Mihnea Stoenescu, under the same license:</p> <p>Copyright (c) 2002-2014 Matt Johnston  Portions copyright (c) 2004 Mihnea Stoenescu  All rights reserved.</p> <p>Permission is hereby granted, free of charge, to any person obtaining a copy of this software and associated documentation files (the "Software"), to deal in the Software without restriction, including without limitation the rights to use, copy, modify, merge, publish, distribute, sublicense, and/or sell copies of the Software, and to permit persons to whom the Software is furnished to do so, subject to the following conditions:</p>

The above copyright notice and this permission notice shall be included in all copies or substantial portions of the Software.

THE SOFTWARE IS PROVIDED "AS IS", WITHOUT WARRANTY OF ANY KIND, EXPRESS OR IMPLIED, INCLUDING BUT NOT LIMITED TO THE WARRANTIES OF MERCHANTABILITY, FITNESS FOR A PARTICULAR PURPOSE AND NONINFRINGEMENT. IN NO EVENT SHALL THE AUTHORS OR COPYRIGHT HOLDERS BE LIABLE FOR ANY CLAIM, DAMAGES OR OTHER LIABILITY, WHETHER IN AN ACTION OF CONTRACT, TORT OR OTHERWISE, ARISING FROM, OUT OF OR IN CONNECTION WITH THE SOFTWARE OR THE USE OR OTHER DEALINGS IN THE SOFTWARE.

=====

LibTomCrypt and LibTomMath are written by Tom St Denis, and are Public Domain.

=====

sshpty.c is taken from OpenSSH 3.5p1,  
Copyright (c) 1995 Tatu Ylonen <ylo@cs.hut.fi>, Espoo, Finland  
All rights reserved

"As far as I am concerned, the code I have written for this software can be used freely for any purpose. Any derived versions of this software must be clearly marked as such, and if the derived work is incompatible with the protocol description in the RFC file, it must be called by a name other than "ssh" or "Secure Shell". "

=====

=====

loginrec.c  
loginrec.h  
atomicio.h  
atomicio.c

and strlcat() (included in util.c) are from OpenSSH 3.6.1p2, and are licensed under the 2 point BSD license.

loginrec is written primarily by Andre Lucas, atomicio.c by Theo de Raadt.

strlcat() is (c) Todd C. Miller

=====

Import code in keyimport.c is modified from PuTTY's import.c, licensed as follows:

PuTTY is copyright 1997-2003 Simon Tatham.

Portions copyright Robert de Bath, Joris van Rantwijk, Delian Delchev, Andreas Schultz, Jeroen Massar, Wez Furlong, Nicolas Barry, Justin Bradford, and CORE SDI S.A.

Permission is hereby granted, free of charge, to any person

obtaining a copy of this software and associated documentation files (the "Software"), to deal in the Software without restriction, including without limitation the rights to use, copy, modify, merge, publish, distribute, sublicense, and/or sell copies of the Software, and to permit persons to whom the Software is furnished to do so, subject to the following conditions:

The above copyright notice and this permission notice shall be included in all copies or substantial portions of the Software.

THE SOFTWARE IS PROVIDED "AS IS", WITHOUT WARRANTY OF ANY KIND, EXPRESS OR IMPLIED, INCLUDING BUT NOT LIMITED TO THE WARRANTIES OF MERCHANTABILITY, FITNESS FOR A PARTICULAR PURPOSE AND NONINFRINGEMENT. IN NO EVENT SHALL THE COPYRIGHT HOLDERS BE LIABLE FOR ANY CLAIM, DAMAGES OR OTHER LIABILITY, WHETHER IN AN ACTION OF CONTRACT, TORT OR OTHERWISE, ARISING FROM, OUT OF OR IN CONNECTION WITH THE SOFTWARE OR THE USE OR OTHER DEALINGS IN THE SOFTWARE.

=====

curve25519-donna:

/\* Copyright 2008, Google Inc.

\* All rights reserved.

\*

\* Redistribution and use in source and binary forms, with or without  
\* modification, are permitted provided that the following conditions are  
\* met:

\*

\* \* Redistributions of source code must retain the above copyright  
\* notice, this list of conditions and the following disclaimer.

\* \* Redistributions in binary form must reproduce the above  
\* copyright notice, this list of conditions and the following disclaimer  
\* in the documentation and/or other materials provided with the  
\* distribution.

\* \* Neither the name of Google Inc. nor the names of its  
\* contributors may be used to endorse or promote products derived from  
\* this software without specific prior written permission.

\*

\* THIS SOFTWARE IS PROVIDED BY THE COPYRIGHT HOLDERS AND  
\* CONTRIBUTORS

\* "AS IS" AND ANY EXPRESS OR IMPLIED WARRANTIES, INCLUDING,  
\* BUT NOT

\* LIMITED TO, THE IMPLIED WARRANTIES OF MERCHANTABILITY AND  
\* FITNESS FOR

\* A PARTICULAR PURPOSE ARE DISCLAIMED. IN NO EVENT SHALL THE  
\* COPYRIGHT

\* OWNER OR CONTRIBUTORS BE LIABLE FOR ANY DIRECT, INDIRECT,  
\* INCIDENTAL,

\* SPECIAL, EXEMPLARY, OR CONSEQUENTIAL DAMAGES (INCLUDING,  
\* BUT NOT

\* LIMITED TO, PROCUREMENT OF SUBSTITUTE GOODS OR SERVICES;  
\* LOSS OF USE,

\* DATA, OR PROFITS; OR BUSINESS INTERRUPTION) HOWEVER

	<p>CAUSED AND ON ANY  * THEORY OF LIABILITY, WHETHER IN CONTRACT, STRICT LIABILITY,  OR TORT  * (INCLUDING NEGLIGENCE OR OTHERWISE) ARISING IN ANY WAY OUT  OF THE USE  * OF THIS SOFTWARE, EVEN IF ADVISED OF THE POSSIBILITY OF  SUCH DAMAGE.  *  * curve25519-donna: Curve25519 elliptic curve, public key function  *  * <a href="http://code.google.com/p/curve25519-donna/">http://code.google.com/p/curve25519-donna/</a>  *  * Adam Langley &lt;agl@imperialviolet.org&gt;  *  * Derived from public domain C code by Daniel J. Bernstein &lt;djb@cr.yp.to&gt;  *  * More information about curve25519 can be found here  * <a href="http://cr.yp.to/ecdh.html">http://cr.yp.to/ecdh.html</a>  *  * djb's sample implementation of curve25519 is written in a special assembly  * language called qhasm and uses the floating point registers.  *  * This is, almost, a clean room reimplementation from the curve25519 paper.  It  * uses many of the tricks described therein. Only the crecip function is taken  * from the sample implementation.  */</p>
eatables	<pre>/*  * eatables.c, v2.0 July 2002  *  * Author: Bart De Schuymer  *  * This code was stongly inspired on the iptables code which is  * Copyright (C) 1999 Paul `Rusty' Russell &amp; Michael J. Neuling  *  * This program is free software; you can redistribute it and/or  * modify it under the terms of the GNU General Public License as  * published by the Free Software Foundation; either version 2 of the  * License, or (at your option) any later version.  *  * This program is distributed in the hope that it will be useful, but  * WITHOUT ANY WARRANTY; without even the implied warranty of  * MERCHANTABILITY or FITNESS FOR A PARTICULAR PURPOSE. See the GNU  * General Public License for more details.  *  * You should have received a copy of the GNU General Public License  * along with this program; if not, write to the Free Software  * Foundation, Inc., 675 Mass Ave, Cambridge, MA 02139, USA.  */</pre>
ethtool	<p>ethtool is available under the terms of the GNU Public License version 2.</p> <p>See COPYING for details.</p>
eventlog	<p>Redistribution and use in source and binary forms, with or without  modification, are permitted provided that the following conditions  are met:</p> <ol style="list-style-type: none"> <li>1. Redistributions of source code must retain the above copyright  notice, this list of conditions and the following disclaimer.</li> <li>2. Redistributions in binary form must reproduce the above copyright</li> </ol>

	<p>notice, this list of conditions and the following disclaimer in the documentation and/or other materials provided with the distribution.</p> <p>3. Neither the name of BalaBit nor the names of its contributors may be used to endorse or promote products derived from this software without specific prior written permission.</p> <p>THIS SOFTWARE IS PROVIDED BY BALABIT AND CONTRIBUTORS "AS IS" AND ANY EXPRESS OR IMPLIED WARRANTIES, INCLUDING, BUT NOT LIMITED TO, THE IMPLIED WARRANTIES OF MERCHANTABILITY AND FITNESS FOR A PARTICULAR PURPOSE ARE DISCLAIMED. IN NO EVENT SHALL THE AUTHOR OR CONTRIBUTORS BE LIABLE FOR ANY DIRECT, INDIRECT, INCIDENTAL, SPECIAL, EXEMPLARY, OR CONSEQUENTIAL DAMAGES (INCLUDING, BUT NOT LIMITED TO, PROCUREMENT OF SUBSTITUTE GOODS OR SERVICES; LOSS OF USE, DATA, OR PROFITS; OR BUSINESS INTERRUPTION) HOWEVER CAUSED AND ON ANY THEORY OF LIABILITY, WHETHER IN CONTRACT, STRICT LIABILITY, OR TORT (INCLUDING NEGLIGENCE OR OTHERWISE) ARISING IN ANY WAY OUT OF THE USE OF THIS SOFTWARE, EVEN IF ADVISED OF THE POSSIBILITY OF SUCH DAMAGE.</p>
expat	<p>Copyright (c) 1998, 1999, 2000 Thai Open Source Software Center Ltd and Clark Cooper Copyright (c) 2001, 2002, 2003, 2004, 2005, 2006 Expat maintainers.</p> <p>Permission is hereby granted, free of charge, to any person obtaining a copy of this software and associated documentation files (the "Software"), to deal in the Software without restriction, including without limitation the rights to use, copy, modify, merge, publish, distribute, sublicense, and/or sell copies of the Software, and to permit persons to whom the Software is furnished to do so, subject to the following conditions:</p> <p>The above copyright notice and this permission notice shall be included in all copies or substantial portions of the Software.</p> <p>THE SOFTWARE IS PROVIDED "AS IS", WITHOUT WARRANTY OF ANY KIND, EXPRESS OR IMPLIED, INCLUDING BUT NOT LIMITED TO THE WARRANTIES OF MERCHANTABILITY, FITNESS FOR A PARTICULAR PURPOSE AND NONINFRINGEMENT. IN NO EVENT SHALL THE AUTHORS OR COPYRIGHT HOLDERS BE LIABLE FOR ANY CLAIM, DAMAGES OR OTHER LIABILITY, WHETHER IN AN ACTION OF CONTRACT, TORT OR OTHERWISE, ARISING FROM, OUT OF OR IN CONNECTION WITH THE SOFTWARE OR THE USE OR OTHER DEALINGS IN THE SOFTWARE.</p>
file	<p>\$File: COPYING,v 1.1 2008/02/05 19:08:11 christos Exp \$ Copyright (c) Ian F. Darwin 1986, 1987, 1989, 1990, 1991, 1992, 1994, 1995. Software written by Ian F. Darwin and others; maintained 1994- Christos Zoulas.</p>



	<p>This software is not subject to any export provision of the United States Department of Commerce, and may be exported to any country or planet.</p> <p>Redistribution and use in source and binary forms, with or without modification, are permitted provided that the following conditions are met:</p> <ol style="list-style-type: none"> <li>1. Redistributions of source code must retain the above copyright notice immediately at the beginning of the file, without modification, this list of conditions, and the following disclaimer.</li> <li>2. Redistributions in binary form must reproduce the above copyright notice, this list of conditions and the following disclaimer in the documentation and/or other materials provided with the distribution.</li> </ol> <p>THIS SOFTWARE IS PROVIDED BY THE AUTHOR AND CONTRIBUTORS ``AS IS" AND ANY EXPRESS OR IMPLIED WARRANTIES, INCLUDING, BUT NOT LIMITED TO, THE IMPLIED WARRANTIES OF MERCHANTABILITY AND FITNESS FOR A PARTICULAR PURPOSE ARE DISCLAIMED. IN NO EVENT SHALL THE AUTHOR OR CONTRIBUTORS BE LIABLE FOR ANY DIRECT, INDIRECT, INCIDENTAL, SPECIAL, EXEMPLARY, OR CONSEQUENTIAL DAMAGES (INCLUDING, BUT NOT LIMITED TO, PROCUREMENT OF SUBSTITUTE GOODS OR SERVICES; LOSS OF USE, DATA, OR PROFITS; OR BUSINESS INTERRUPTION) HOWEVER CAUSED AND ON ANY THEORY OF LIABILITY, WHETHER IN CONTRACT, STRICT LIABILITY, OR TORT (INCLUDING NEGLIGENCE OR OTHERWISE) ARISING IN ANY WAY OUT OF THE USE OF THIS SOFTWARE, EVEN IF ADVISED OF THE POSSIBILITY OF SUCH DAMAGE.</p>
glib/glib2	<p>GNU LIBRARY GENERAL PUBLIC LICENSE Version 2, June 1991</p> <p>Copyright (C) 1991 Free Software Foundation, Inc. 59 Temple Place, Suite 330, Boston, MA 02111-1307 USA Everyone is permitted to copy and distribute verbatim copies of this license document, but changing it is not allowed.</p> <p>[This is the first released version of the library GPL. It is numbered 2 because it goes with version 2 of the ordinary GPL.]</p>
haproxy	<p>HAPROXY's license - 2006/06/15</p> <p>Historically, haproxy has been covered by GPL version 2. However, an issue appeared in GPL which will prevent external non-GPL code from being built using the headers provided with haproxy. My long-term goal is to build a core system able to load external modules to support specific application protocols.</p> <p>Since some protocols are found in rare environments (finance, industry, ...), some of them might be accessible only after signing an NDA. Enforcing GPL on such modules would only prevent them from ever being implemented, while not providing anything useful to ordinary users.</p>

For this reason, I \*want\* to be able to support binary only external modules when needed, with a GPL core and GPL modules for standard protocols, so that people fixing bugs don't keep them secretly to try to stay over competition.

The solution was then to apply the LGPL license to the exportable include files, while keeping the GPL for all the rest. This way, it still is mandatory to redistribute modified code under customer request, but at the same time, it is expressly permitted to write, compile, link and load non-GPL code using the LGPL header files and not to distribute them if it causes a legal problem.

Of course, users are strongly encouraged to continue the work under GPL as long as possible, since this license has allowed useful enhancements, contributions and fixes from talented people around the world.

Due to the incompatibility between the GPL and the OpenSSL licence, you must apply the GPL/LGPL licence with the following exception:  
This program is released under the GPL with the additional exemption that compiling, linking, and/or using OpenSSL is allowed.

The text of the licenses lies in the "doc" directory. All the files provided in this package are covered by the GPL unless expressly stated otherwise in them.

Every patch or contribution provided by external people will by default comply with the license of the files it affects, or be rejected.

Willy Tarreau - w@1wt.eu

---

i2c-tools

GNU GENERAL PUBLIC LICENSE  
Version 2, June 1991

Copyright (C) 1989, 1991 Free Software Foundation, Inc.,  
51 Franklin Street, Fifth Floor, Boston, MA 02110-1301 USA  
Everyone is permitted to copy and distribute verbatim copies  
of this license document, but changing it is not allowed.

/\*

i2cset.c - A user-space program to write an I2C register.  
Copyright (C) 2001-2003 Frodo Looijaard <frodol@dds.nl>, and  
Mark D. Studebaker <mdsxyz123@yahoo.com>  
Copyright (C) 2004-2012 Jean Delvare <jdelvare@suse.de>

This program is free software; you can redistribute it and/or modify  
it under the terms of the GNU General Public License as published by  
the Free Software Foundation; either version 2 of the License, or  
(at your option) any later version.

This program is distributed in the hope that it will be useful,  
but WITHOUT ANY WARRANTY; without even the implied warranty of  
MERCHANTABILITY or FITNESS FOR A PARTICULAR PURPOSE. See  
the  
GNU General Public License for more details.

You should have received a copy of the GNU General Public License  
along with this program; if not, write to the Free Software  
Foundation, Inc., 51 Franklin Street, Fifth Floor, Boston,  
MA 02110-1301 USA.

\*/

iperf	<p>Copyright (c) 1999-2007, The Board of Trustees of the University of Illinois All Rights Reserved.</p> <p>Iperf performance test Mark Gates Ajay Tirumala Jim Ferguson Jon Dugan Feng Qin Kevin Gibbs John Estabrook National Laboratory for Applied Network Research National Center for Supercomputing Applications University of Illinois at Urbana-Champaign <a href="http://www.ncsa.uiuc.edu">http://www.ncsa.uiuc.edu</a></p> <p>Permission is hereby granted, free of charge, to any person obtaining a copy of this software (Iperf) and associated documentation files (the "Software"), to deal in the Software without restriction, including without limitation the rights to use, copy, modify, merge, publish, distribute, sublicense, and/or sell copies of the Software, and to permit persons to whom the Software is furnished to do so, subject to the following conditions:</p> <p>Redistributions of source code must retain the above copyright notice, this list of conditions and the following disclaimers.</p> <p>Redistributions in binary form must reproduce the above copyright notice, this list of conditions and the following disclaimers in the documentation and/or other materials provided with the distribution.</p> <p>Neither the names of the University of Illinois, NCSA, nor the names of its contributors may be used to endorse or promote products derived from this Software without specific prior written permission. THE SOFTWARE IS PROVIDED "AS IS", WITHOUT WARRANTY OF ANY KIND, EXPRESS OR IMPLIED, INCLUDING BUT NOT LIMITED TO THE WARRANTIES OF MERCHANTABILITY, FITNESS FOR A PARTICULAR PURPOSE AND NONINFRINGEMENT. IN NO EVENT SHALL THE CONTRIBUTORS OR COPYRIGHT HOLDERS BE LIABLE FOR ANY CLAIM, DAMAGES OR OTHER LIABILITY, WHETHER IN AN ACTION OF CONTRACT, TORT OR OTHERWISE, ARISING FROM, OUT OF OR IN CONNECTION WITH THE SOFTWARE OR THE USE OR OTHER DEALINGS IN THE SOFTWARE.</p>
iproute2	<p>GNU GENERAL PUBLIC LICENSE Version 2, June 1991</p> <p>Copyright (C) 1989, 1991 Free Software Foundation, Inc. 51 Franklin St, Fifth Floor, Boston, MA 02110-1301 USA</p> <p>Everyone is permitted to copy and distribute verbatim copies of this license document, but changing it is not allowed.</p> <pre>/*  * ip.c      "ip" utility frontend.  *  * This program is free software; you can redistribute it and/or  * modify it under the terms of the GNU General Public License  * as published by the Free Software Foundation; either version</pre>

	<pre> *       2 of the License, or (at your option) any later version. * * Authors:  Alexey Kuznetsov, &lt;kuznet@ms2.inr.ac.ru&gt; */ </pre>
iptables	<pre> /* * Author: Paul.Russell@rustcorp.com.au and mneuling@radlogic.com.au * * (C) 2000-2002 by the netfilter coreteam &lt;coreteam@netfilter.org&gt;: *   Paul 'Rusty' Russell &lt;rusty@rustcorp.com.au&gt; *   Marc Boucher &lt;marc+nf@mbsi.ca&gt; *   James Morris &lt;jmorris@intercode.com.au&gt; *   Harald Welte &lt;laforge@gnumonks.org&gt; *   Jozsef Kadlecsek &lt;kadlec@blackhole.kfki.hu&gt; * * Based on the ipchains code by Paul Russell and Michael Neuling * * iptables -- IP firewall administration for kernels with * firewall table (aimed for the 2.3 kernels) * * See the accompanying manual page iptables(8) for information * about proper usage of this program. * * This program is free software; you can redistribute it and/or modify * it under the terms of the GNU General Public License as published by * the Free Software Foundation; either version 2 of the License, or * (at your option) any later version. * * This program is distributed in the hope that it will be useful, * but WITHOUT ANY WARRANTY; without even the implied warranty of * MERCHANTABILITY or FITNESS FOR A PARTICULAR PURPOSE. See the * GNU General Public License for more details. * * You should have received a copy of the GNU General Public License * along with this program; if not, write to the Free Software * Foundation, Inc., 675 Mass Ave, Cambridge, MA 02139, USA. */ </pre>
iw	<pre> Copyright (c) 2007, 2008   Johannes Berg Copyright (c) 2007       Andy Lutomirski Copyright (c) 2007       Mike Kershaw Copyright (c) 2008-2009   Luis R. Rodriguez  Permission to use, copy, modify, and/or distribute this software for any purpose with or without fee is hereby granted, provided that the above copyright notice and this permission notice appear in all copies.  THE SOFTWARE IS PROVIDED "AS IS" AND THE AUTHOR DISCLAIMS ALL WARRANTIES WITH REGARD TO THIS SOFTWARE INCLUDING ALL IMPLIED WARRANTIES OF MERCHANTABILITY AND FITNESS. IN NO EVENT SHALL THE AUTHOR BE LIABLE FOR ANY SPECIAL, DIRECT, INDIRECT, OR CONSEQUENTIAL DAMAGES OR ANY DAMAGES WHATSOEVER RESULTING FROM LOSS OF USE, DATA OR PROFITS, WHETHER IN AN ACTION OF CONTRACT, NEGLIGENCE OR OTHER TORTIOUS ACTION, ARISING OUT OF </pre>

	<p>OR IN CONNECTION WITH THE USE OR PERFORMANCE OF THIS SOFTWARE.</p>
<p>jansson</p>	<p>Copyright (c) 2009-2014 Petri Lehtinen &lt;petri@digip.org&gt;</p> <p>Permission is hereby granted, free of charge, to any person obtaining a copy of this software and associated documentation files (the "Software"), to deal in the Software without restriction, including without limitation the rights to use, copy, modify, merge, publish, distribute, sublicense, and/or sell copies of the Software, and to permit persons to whom the Software is furnished to do so, subject to the following conditions:</p> <p>The above copyright notice and this permission notice shall be included in all copies or substantial portions of the Software.</p> <p>THE SOFTWARE IS PROVIDED "AS IS", WITHOUT WARRANTY OF ANY KIND, EXPRESS OR IMPLIED, INCLUDING BUT NOT LIMITED TO THE WARRANTIES OF MERCHANTABILITY, FITNESS FOR A PARTICULAR PURPOSE AND NONINFRINGEMENT. IN NO EVENT SHALL THE AUTHORS OR COPYRIGHT HOLDERS BE LIABLE FOR ANY CLAIM, DAMAGES OR OTHER LIABILITY, WHETHER IN AN ACTION OF CONTRACT, TORT OR OTHERWISE, ARISING FROM, OUT OF OR IN CONNECTION WITH THE SOFTWARE OR THE USE OR OTHER DEALINGS IN THE SOFTWARE.</p>
<p>json-c</p>	<p>Copyright (c) 2009-2012 Eric Haszlakiewicz</p> <p>Permission is hereby granted, free of charge, to any person obtaining a copy of this software and associated documentation files (the "Software"), to deal in the Software without restriction, including without limitation the rights to use, copy, modify, merge, publish, distribute, sublicense, and/or sell copies of the Software, and to permit persons to whom the Software is furnished to do so, subject to the following conditions:</p> <p>The above copyright notice and this permission notice shall be included in all copies or substantial portions of the Software.</p> <p>THE SOFTWARE IS PROVIDED "AS IS", WITHOUT WARRANTY OF ANY KIND, EXPRESS OR IMPLIED, INCLUDING BUT NOT LIMITED TO THE WARRANTIES OF MERCHANTABILITY, FITNESS FOR A PARTICULAR PURPOSE AND NONINFRINGEMENT. IN NO EVENT SHALL THE AUTHORS OR COPYRIGHT HOLDERS BE LIABLE FOR ANY CLAIM, DAMAGES OR OTHER LIABILITY, WHETHER IN AN ACTION OF CONTRACT, TORT OR OTHERWISE, ARISING FROM, OUT OF OR IN CONNECTION WITH THE SOFTWARE OR THE USE OR OTHER DEALINGS IN THE SOFTWARE.</p> <p>-----</p> <p>Copyright (c) 2004, 2005 Metaparadigm Pte Ltd</p> <p>Permission is hereby granted, free of charge, to any person obtaining a</p>

	<p>copy of this software and associated documentation files (the "Software"), to deal in the Software without restriction, including without limitation the rights to use, copy, modify, merge, publish, distribute, sublicense, and/or sell copies of the Software, and to permit persons to whom the Software is furnished to do so, subject to the following conditions:</p> <p>The above copyright notice and this permission notice shall be included in all copies or substantial portions of the Software.</p> <p>THE SOFTWARE IS PROVIDED "AS IS", WITHOUT WARRANTY OF ANY KIND, EXPRESS OR IMPLIED, INCLUDING BUT NOT LIMITED TO THE WARRANTIES OF MERCHANTABILITY, FITNESS FOR A PARTICULAR PURPOSE AND NONINFRINGEMENT. IN NO EVENT SHALL THE AUTHORS OR COPYRIGHT HOLDERS BE LIABLE FOR ANY CLAIM, DAMAGES OR OTHER LIABILITY, WHETHER IN AN ACTION OF CONTRACT, TORT OR OTHERWISE, ARISING FROM, OUT OF OR IN CONNECTION WITH THE SOFTWARE OR THE USE OR OTHER DEALINGS IN THE SOFTWARE.</p>
libelf	<pre>/*  * elf_repl.h - public header file for systems that lack it.  * Copyright (C) 1995 - 2006 Michael Riepe  *  * This library is free software; you can redistribute it and/or  * modify it under the terms of the GNU Library General Public  * License as published by the Free Software Foundation; either  * version 2 of the License, or (at your option) any later version.  *  * This library is distributed in the hope that it will be useful,  * but WITHOUT ANY WARRANTY; without even the implied warranty of  * MERCHANTABILITY or FITNESS FOR A PARTICULAR PURPOSE. See  * the GNU  * Library General Public License for more details.  *  * You should have received a copy of the GNU Library General Public  * License along with this library; if not, write to the Free Software  * Foundation, Inc., 51 Franklin Street, Fifth Floor, Boston, MA 02110-1301,  * USA  */</pre>
libevent	<p>Libevent is available for use under the following license, commonly known as the 3-clause (or "modified") BSD license:</p> <pre>===== Copyright (c) 2000-2007 Niels Provos &lt;provos@citi.umich.edu&gt; Copyright (c) 2007-2012 Niels Provos and Nick Mathewson</pre> <p>Redistribution and use in source and binary forms, with or without modification, are permitted provided that the following conditions are met:</p> <ol style="list-style-type: none"> <li>1. Redistributions of source code must retain the above copyright notice, this list of conditions and the following disclaimer.</li> <li>2. Redistributions in binary form must reproduce the above copyright notice, this list of conditions and the following disclaimer in the documentation and/or other materials provided with the distribution.</li> <li>3. The name of the author may not be used to endorse or promote products derived from this software without specific prior written permission.</li> </ol>

THIS SOFTWARE IS PROVIDED BY THE AUTHOR "AS IS" AND ANY EXPRESS OR IMPLIED WARRANTIES, INCLUDING, BUT NOT LIMITED TO, THE IMPLIED WARRANTIES OF MERCHANTABILITY AND FITNESS FOR A PARTICULAR PURPOSE ARE DISCLAIMED. IN NO EVENT SHALL THE AUTHOR BE LIABLE FOR ANY DIRECT, INDIRECT, INCIDENTAL, SPECIAL, EXEMPLARY, OR CONSEQUENTIAL DAMAGES (INCLUDING, BUT NOT LIMITED TO, PROCUREMENT OF SUBSTITUTE GOODS OR SERVICES; LOSS OF USE, DATA, OR PROFITS; OR BUSINESS INTERRUPTION) HOWEVER CAUSED AND ON ANY THEORY OF LIABILITY, WHETHER IN CONTRACT, STRICT LIABILITY, OR TORT (INCLUDING NEGLIGENCE OR OTHERWISE) ARISING IN ANY WAY OUT OF THE USE OF THIS SOFTWARE, EVEN IF ADVISED OF THE POSSIBILITY OF SUCH DAMAGE.

=====

Portions of Libevent are based on works by others, also made available by them under the three-clause BSD license above. The copyright notices are available in the corresponding source files; the license is as above. Here's a list:

log.c:

Copyright (c) 2000 Dug Song <dugsong@monkey.org>  
Copyright (c) 1993 The Regents of the University of California.

strlcpy.c:

Copyright (c) 1998 Todd C. Miller <Todd.Miller@courtesan.com>

win32select.c:

Copyright (c) 2003 Michael A. Davis <mike@datanerds.net>

evport.c:

Copyright (c) 2007 Sun Microsystems

ht-internal.h:

Copyright (c) 2002 Christopher Clark

minheap-internal.h:

Copyright (c) 2006 Maxim Yegorushkin <maxim.yegorushkin@gmail.com>

=====

The arc4module is available under the following, sometimes called the "OpenBSD" license:

Copyright (c) 1996, David Mazieres <dm@uun.org>  
Copyright (c) 2008, Damien Miller <djm@openbsd.org>

Permission to use, copy, modify, and distribute this software for any purpose with or without fee is hereby granted, provided that the above copyright notice and this permission notice appear in all copies.

	<p>THE SOFTWARE IS PROVIDED "AS IS" AND THE AUTHOR DISCLAIMS ALL WARRANTIES WITH REGARD TO THIS SOFTWARE INCLUDING ALL IMPLIED WARRANTIES OF MERCHANTABILITY AND FITNESS. IN NO EVENT SHALL THE AUTHOR BE LIABLE FOR ANY SPECIAL, DIRECT, INDIRECT, OR CONSEQUENTIAL DAMAGES OR ANY DAMAGES WHATSOEVER RESULTING FROM LOSS OF USE, DATA OR PROFITS, WHETHER IN AN ACTION OF CONTRACT, NEGLIGENCE OR OTHER TORTIOUS ACTION, ARISING OUT OF OR IN CONNECTION WITH THE USE OR PERFORMANCE OF THIS SOFTWARE.</p>
libffi	<p>libffi - Copyright (c) 1996-2012 Anthony Green, Red Hat, Inc and others. See source files for details.</p> <p>Permission is hereby granted, free of charge, to any person obtaining a copy of this software and associated documentation files (the ``Software``), to deal in the Software without restriction, including without limitation the rights to use, copy, modify, merge, publish, distribute, sublicense, and/or sell copies of the Software, and to permit persons to whom the Software is furnished to do so, subject to the following conditions:</p> <p>The above copyright notice and this permission notice shall be included in all copies or substantial portions of the Software.</p> <p>THE SOFTWARE IS PROVIDED ``AS IS``, WITHOUT WARRANTY OF ANY KIND, EXPRESS OR IMPLIED, INCLUDING BUT NOT LIMITED TO THE WARRANTIES OF MERCHANTABILITY, FITNESS FOR A PARTICULAR PURPOSE AND NONINFRINGEMENT. IN NO EVENT SHALL THE AUTHORS OR COPYRIGHT HOLDERS BE LIABLE FOR ANY CLAIM, DAMAGES OR OTHER LIABILITY, WHETHER IN AN ACTION OF CONTRACT, TORT OR OTHERWISE, ARISING FROM, OUT OF OR IN CONNECTION WITH THE SOFTWARE OR THE USE OR OTHER DEALINGS IN THE SOFTWARE.</p> <p>/* -----  ffi.c - Copyright (c) 1996, 1998, 1999, 2001, 2007, 2008 Red Hat, Inc.  Copyright (c) 2002 Ranjit Mathew  Copyright (c) 2002 Bo Thorsen  Copyright (c) 2002 Roger Sayle  Copyright (C) 2008, 2010 Free Software Foundation, Inc.</p> <p>x86 Foreign Function Interface</p> <p>Permission is hereby granted, free of charge, to any person obtaining a copy of this software and associated documentation files (the ``Software``), to deal in the Software without restriction, including without limitation the rights to use, copy, modify, merge, publish, distribute, sublicense, and/or sell copies of the Software, and to permit persons to whom the Software is furnished to do so, subject to the following conditions:</p> <p>The above copyright notice and this permission notice shall be included</p>



	<p>in all copies or substantial portions of the Software.</p> <p>THE SOFTWARE IS PROVIDED ``AS IS'', WITHOUT WARRANTY OF ANY KIND,  EXPRESS OR IMPLIED, INCLUDING BUT NOT LIMITED TO THE WARRANTIES OF  MERCHANTABILITY, FITNESS FOR A PARTICULAR PURPOSE AND NONINFRINGEMENT. IN NO EVENT SHALL THE AUTHORS OR  COPYRIGHT  HOLDERS BE LIABLE FOR ANY CLAIM, DAMAGES OR OTHER LIABILITY,  WHETHER IN AN ACTION OF CONTRACT, TORT OR OTHERWISE, ARISING FROM,  OUT OF OR IN CONNECTION WITH THE SOFTWARE OR THE USE OR OTHER  OTHER  DEALINGS IN THE SOFTWARE.</p>
libiwinfo	<pre> * * iwinfo - Wireless Information Library - Broadcom wl.o Backend * * Copyright (C) 2009 Jo-Philipp Wich &lt;xm@subsignal.org&gt; * * The iwinfo library is free software: you can redistribute it and/or * modify it under the terms of the GNU General Public License version 2 * as published by the Free Software Foundation. * * The iwinfo library is distributed in the hope that it will be useful, * but WITHOUT ANY WARRANTY; without even the implied warranty of * MERCHANTABILITY or FITNESS FOR A PARTICULAR PURPOSE. * See the GNU General Public License for more details. * * You should have received a copy of the GNU General Public License along * with the iwinfo library. If not, see http://www.gnu.org/licenses/. * * This code is based on the wlc.c utility published by OpenWrt.org . */ </pre>
libnetfilter_contrack	<pre> /* * (C) 2005-2011 by Pablo Neira Ayuso &lt;pablo@netfilter.org&gt; * Harald Welte &lt;laforge@netfilter.org&gt; * * This program is free software; you can redistribute it and/or modify it * under the terms of the GNU General Public License as published by * the Free Software Foundation; either version 2 of the License, or * (at your option) any later version. */ </pre>
libnetfilter_cthelper	<p>GNU GENERAL PUBLIC LICENSE  Version 2, June 1991</p> <p>Copyright (C) 1989, 1991 Free Software Foundation, Inc.  675 Mass Ave, Cambridge, MA 02139, USA  Everyone is permitted to copy and distribute verbatim copies  of this license document, but changing it is not allowed.</p>
libnetfilter_cttimeout	<p>GNU GENERAL PUBLIC LICENSE  Version 2, June 1991</p> <p>Copyright (C) 1989, 1991 Free Software Foundation, Inc.  675 Mass Ave, Cambridge, MA 02139, USA  Everyone is permitted to copy and distribute verbatim copies  of this license document, but changing it is not allowed.</p>

libnetfilter_queue	<p>GNU GENERAL PUBLIC LICENSE Version 2, June 1991</p> <p>Copyright (C) 1989, 1991 Free Software Foundation, Inc. 675 Mass Ave, Cambridge, MA 02139, USA Everyone is permitted to copy and distribute verbatim copies of this license document, but changing it is not allowed.</p>
libnfnetlink	<p>GNU GENERAL PUBLIC LICENSE Version 2, June 1991</p> <p>Copyright (C) 1989, 1991 Free Software Foundation, Inc. 675 Mass Ave, Cambridge, MA 02139, USA Everyone is permitted to copy and distribute verbatim copies of this license document, but changing it is not allowed.</p>
libnl	<p>GNU LESSER GENERAL PUBLIC LICENSE Version 2.1, February 1999</p> <p>Copyright (C) 1991, 1999 Free Software Foundation, Inc. 51 Franklin Street, Fifth Floor, Boston, MA 02110-1301 USA Everyone is permitted to copy and distribute verbatim copies of this license document, but changing it is not allowed.</p> <p>[This is the first released version of the Lesser GPL. It also counts as the successor of the GNU Library Public License, version 2, hence the version number 2.1.]</p>
libpcap	<p>License: BSD</p> <p>Redistribution and use in source and binary forms, with or without modification, are permitted provided that the following conditions are met:</p> <ol style="list-style-type: none"> <li>1. Redistributions of source code must retain the above copyright notice, this list of conditions and the following disclaimer.</li> <li>2. Redistributions in binary form must reproduce the above copyright notice, this list of conditions and the following disclaimer in the documentation and/or other materials provided with the distribution.</li> <li>3. The names of the authors may not be used to endorse or promote products derived from this software without specific prior written permission.</li> </ol> <p>THIS SOFTWARE IS PROVIDED ``AS IS" AND WITHOUT ANY EXPRESS OR IMPLIED WARRANTIES, INCLUDING, WITHOUT LIMITATION, THE IMPLIED WARRANTIES OF MERCHANTABILITY AND FITNESS FOR A PARTICULAR PURPOSE.</p>
libwebsockets	<pre>/*  * libwebsockets - small server side websockets and web server  * implementation  *  * Copyright (C) 2010-2014 Andy Green &lt;andy@warmcat.com&gt;  *  * This library is free software; you can redistribute it and/or  * modify it under the terms of the GNU Lesser General Public  * License as published by the Free Software Foundation:  * version 2.1 of the License.  *  * This library is distributed in the hope that it will be useful,</pre>

	<p>* but WITHOUT ANY WARRANTY; without even the implied warranty of  * MERCHANTABILITY or FITNESS FOR A PARTICULAR PURPOSE. See  the GNU  * Lesser General Public License for more details.  *  * You should have received a copy of the GNU Lesser General Public  * License along with this library; if not, write to the Free Software  * Foundation, Inc., 51 Franklin Street, Fifth Floor, Boston,  * MA 02110-1301 USA  */</p>
libxml2	<p>Except where otherwise noted in the source code (e.g. the files hash.c,  list.c and the trio files, which are covered by a similar licence but  with different Copyright notices) all the files are:</p> <p>Copyright (C) 1998-2012 Daniel Veillard. All Rights Reserved.</p> <p>Permission is hereby granted, free of charge, to any person obtaining a copy  of this software and associated documentation files (the "Software"), to deal  in the Software without restriction, including without limitation the rights  to use, copy, modify, merge, publish, distribute, sublicense, and/or sell  copies of the Software, and to permit persons to whom the Software is fur-  nished to do so, subject to the following conditions:</p> <p>The above copyright notice and this permission notice shall be included in  all copies or substantial portions of the Software.</p> <p>THE SOFTWARE IS PROVIDED "AS IS", WITHOUT WARRANTY OF ANY  KIND, EXPRESS OR  IMPLIED, INCLUDING BUT NOT LIMITED TO THE WARRANTIES OF  MERCHANTABILITY, FIT-  NESS FOR A PARTICULAR PURPOSE AND NONINFRINGEMENT. IN NO  EVENT SHALL THE  AUTHORS OR COPYRIGHT HOLDERS BE LIABLE FOR ANY CLAIM,  DAMAGES OR OTHER  LIABILITY, WHETHER IN AN ACTION OF CONTRACT, TORT OR  OTHERWISE, ARISING FROM,  OUT OF OR IN CONNECTION WITH THE SOFTWARE OR THE USE OR  OTHER DEALINGS IN  THE SOFTWARE.</p>
lighttpd	<p>Copyright (c) 2004, Jan Kneschke, incremental  All rights reserved.</p> <p>Redistribution and use in source and binary forms, with or without  modification, are permitted provided that the following conditions are met:</p> <ul style="list-style-type: none"> <li>- Redistributions of source code must retain the above copyright notice, this  list of conditions and the following disclaimer.</li> <li>- Redistributions in binary form must reproduce the above copyright notice,  this list of conditions and the following disclaimer in the documentation  and/or other materials provided with the distribution.</li> <li>- Neither the name of the 'incremental' nor the names of its contributors may  be used to endorse or promote products derived from this software without  specific prior written permission.</li> </ul> <p>THIS SOFTWARE IS PROVIDED BY THE COPYRIGHT HOLDERS AND  CONTRIBUTORS "AS IS"  AND ANY EXPRESS OR IMPLIED WARRANTIES, INCLUDING, BUT NOT</p>

	<p>LIMITED TO, THE IMPLIED WARRANTIES OF MERCHANTABILITY AND FITNESS FOR A PARTICULAR PURPOSE ARE DISCLAIMED. IN NO EVENT SHALL THE COPYRIGHT OWNER OR CONTRIBUTORS BE LIABLE FOR ANY DIRECT, INDIRECT, INCIDENTAL, SPECIAL, EXEMPLARY, OR CONSEQUENTIAL DAMAGES (INCLUDING, BUT NOT LIMITED TO, PROCUREMENT OF SUBSTITUTE GOODS OR SERVICES; LOSS OF USE, DATA, OR PROFITS; OR BUSINESS INTERRUPTION) HOWEVER CAUSED AND ON ANY THEORY OF LIABILITY, WHETHER IN CONTRACT, STRICT LIABILITY, OR TORT (INCLUDING NEGLIGENCE OR OTHERWISE) ARISING IN ANY WAY OUT OF THE USE OF THIS SOFTWARE, EVEN IF ADVISED OF THE POSSIBILITY OF SUCH DAMAGE.</p>
Linux-PAM	<p>Unless otherwise *explicitly* stated the following text describes the licensed conditions under which the contents of this Linux-PAM release may be distributed:</p> <p>-----</p> <p>Redistribution and use in source and binary forms of Linux-PAM, with or without modification, are permitted provided that the following conditions are met:</p> <ol style="list-style-type: none"> <li>1. Redistributions of source code must retain any existing copyright notice, and this entire permission notice in its entirety, including the disclaimer of warranties.</li> <li>2. Redistributions in binary form must reproduce all prior and current copyright notices, this list of conditions, and the following disclaimer in the documentation and/or other materials provided with the distribution.</li> <li>3. The name of any author may not be used to endorse or promote products derived from this software without their specific prior written permission.</li> </ol> <p>ALTERNATIVELY, this product may be distributed under the terms of the GNU General Public License, in which case the provisions of the GNU GPL are required INSTEAD OF the above restrictions. (This clause is necessary due to a potential conflict between the GNU GPL and the restrictions contained in a BSD-style copyright.)</p> <p>THIS SOFTWARE IS PROVIDED ``AS IS" AND ANY EXPRESS OR IMPLIED WARRANTIES, INCLUDING, BUT NOT LIMITED TO, THE IMPLIED WARRANTIES OF MERCHANTABILITY AND FITNESS FOR A PARTICULAR PURPOSE ARE DISCLAIMED. IN NO EVENT SHALL THE AUTHOR(S) BE LIABLE FOR ANY DIRECT, INDIRECT, INCIDENTAL, SPECIAL, EXEMPLARY, OR CONSEQUENTIAL DAMAGES (INCLUDING, BUT NOT LIMITED TO, PROCUREMENT OF SUBSTITUTE GOODS OR SERVICES; LOSS OF USE, DATA, OR PROFITS; OR BUSINESS INTERRUPTION) HOWEVER CAUSED AND ON ANY THEORY OF LIABILITY, WHETHER IN CONTRACT, STRICT</p>

	<p>LIABILITY, OR TORT (INCLUDING NEGLIGENCE OR OTHERWISE) ARISING IN ANY WAY OUT OF THE USE OF THIS SOFTWARE, EVEN IF ADVISED OF THE POSSIBILITY OF SUCH DAMAGE.</p> <p>-----</p>
lldpd	<p>License -----</p> <p>lldpd is distributed under the ISC license:</p> <ul style="list-style-type: none"> <li>&gt; Permission to use, copy, modify, and/or distribute this software for any</li> <li>&gt; purpose with or without fee is hereby granted, provided that the above</li> <li>&gt; copyright notice and this permission notice appear in all copies.</li> <li>&gt;</li> <li>&gt; THE SOFTWARE IS PROVIDED "AS IS" AND THE AUTHOR DISCLAIMS ALL WARRANTIES</li> <li>&gt; WITH REGARD TO THIS SOFTWARE INCLUDING ALL IMPLIED WARRANTIES OF</li> <li>&gt; MERCHANTABILITY AND FITNESS. IN NO EVENT SHALL THE AUTHOR BE LIABLE FOR</li> <li>&gt; ANY SPECIAL, DIRECT, INDIRECT, OR CONSEQUENTIAL DAMAGES OR ANY DAMAGES</li> <li>&gt; WHATSOEVER RESULTING FROM LOSS OF USE, DATA OR PROFITS, WHETHER IN AN</li> <li>&gt; ACTION OF CONTRACT, NEGLIGENCE OR OTHER TORTIOUS ACTION, ARISING OUT OF</li> <li>&gt; OR IN CONNECTION WITH THE USE OR PERFORMANCE OF THIS SOFTWARE.</li> </ul> <p>Also, `lldpcli` will be linked to GNU Readline (which is GPL licensed) if available. To avoid this, use `--without-readline` as a configure option.</p> <pre>/*  * Copyright (c) 2008 Vincent Bernat &lt;bernat@luffy.cx&gt;  *  * Permission to use, copy, modify, and/or distribute this software for any  * purpose with or without fee is hereby granted, provided that the above  * copyright notice and this permission notice appear in all copies.  *  * THE SOFTWARE IS PROVIDED "AS IS" AND THE AUTHOR DISCLAIMS ALL WARRANTIES  * WITH REGARD TO THIS SOFTWARE INCLUDING ALL IMPLIED WARRANTIES OF  * MERCHANTABILITY AND FITNESS. IN NO EVENT SHALL THE AUTHOR BE LIABLE FOR  * ANY SPECIAL, DIRECT, INDIRECT, OR CONSEQUENTIAL DAMAGES OR ANY DAMAGES  * WHATSOEVER RESULTING FROM LOSS OF USE, DATA OR PROFITS, WHETHER IN AN  * ACTION OF CONTRACT, NEGLIGENCE OR OTHER TORTIOUS ACTION, ARISING OUT OF  * OR IN CONNECTION WITH THE USE OR PERFORMANCE OF THIS SOFTWARE.  */</pre>
lua-cjson	<p>Copyright (c) 2010-2012 Mark Pulford &lt;mark@kyne.com.au&gt;</p> <p>Permission is hereby granted, free of charge, to any person obtaining</p>

	<p>a copy of this software and associated documentation files (the "Software"), to deal in the Software without restriction, including without limitation the rights to use, copy, modify, merge, publish, distribute, sublicense, and/or sell copies of the Software, and to permit persons to whom the Software is furnished to do so, subject to the following conditions:</p> <p>The above copyright notice and this permission notice shall be included in all copies or substantial portions of the Software.</p> <p>THE SOFTWARE IS PROVIDED "AS IS", WITHOUT WARRANTY OF ANY KIND, EXPRESS OR IMPLIED, INCLUDING BUT NOT LIMITED TO THE WARRANTIES OF MERCHANTABILITY, FITNESS FOR A PARTICULAR PURPOSE AND NONINFRINGEMENT. IN NO EVENT SHALL THE AUTHORS OR COPYRIGHT HOLDERS BE LIABLE FOR ANY CLAIM, DAMAGES OR OTHER LIABILITY, WHETHER IN AN ACTION OF CONTRACT, TORT OR OTHERWISE, ARISING FROM, OUT OF OR IN CONNECTION WITH THE SOFTWARE OR THE USE OR OTHER DEALINGS IN THE SOFTWARE.</p>
mcproxy	<p>GNU GENERAL PUBLIC LICENSE Version 2, June 1991</p> <p>Copyright (C) 1989, 1991 Free Software Foundation, Inc., 51 Franklin Street, Fifth Floor, Boston, MA 02110-1301 USA Everyone is permitted to copy and distribute verbatim copies of this license document, but changing it is not allowed.</p>
minicom	<p>Minicom is Copyright (C) 1991,1992,1993,1994,1995,1996 Miquel van Smoorenburg.</p> <p>GNU GENERAL PUBLIC LICENSE Version 2, June 1991</p> <p>Copyright (C) 1989, 1991 Free Software Foundation, Inc., 51 Franklin Street, Fifth Floor, Boston, MA 02110-1301 USA Everyone is permitted to copy and distribute verbatim copies of this license document, but changing it is not allowed.</p>
miniupnpd	<p>MiniUPnPd Copyright (c) 2006-2015, Thomas BERNARD All rights reserved.</p> <p>Redistribution and use in source and binary forms, with or without modification, are permitted provided that the following conditions are met:</p> <ul style="list-style-type: none"> <li>* Redistributions of source code must retain the above copyright notice, this list of conditions and the following disclaimer.</li> <li>* Redistributions in binary form must reproduce the above copyright notice, this list of conditions and the following disclaimer in the documentation and/or other materials provided with the distribution.</li> <li>* The name of the author may not be used to endorse or promote products derived from this software without specific prior written permission.</li> </ul> <p>THIS SOFTWARE IS PROVIDED BY THE COPYRIGHT HOLDERS AND CONTRIBUTORS "AS IS" AND ANY EXPRESS OR IMPLIED WARRANTIES, INCLUDING, BUT NOT</p>

	<p>LIMITED TO, THE IMPLIED WARRANTIES OF MERCHANTABILITY AND FITNESS FOR A PARTICULAR PURPOSE ARE DISCLAIMED. IN NO EVENT SHALL THE COPYRIGHT OWNER OR CONTRIBUTORS BE LIABLE FOR ANY DIRECT, INDIRECT, INCIDENTAL, SPECIAL, EXEMPLARY, OR CONSEQUENTIAL DAMAGES (INCLUDING, BUT NOT LIMITED TO, PROCUREMENT OF SUBSTITUTE GOODS OR SERVICES; LOSS OF USE, DATA, OR PROFITS; OR BUSINESS INTERRUPTION) HOWEVER CAUSED AND ON ANY THEORY OF LIABILITY, WHETHER IN CONTRACT, STRICT LIABILITY, OR TORT (INCLUDING NEGLIGENCE OR OTHERWISE) ARISING IN ANY WAY OUT OF THE USE OF THIS SOFTWARE, EVEN IF ADVISED OF THE POSSIBILITY OF SUCH DAMAGE.</p>
mtd-utils	<p>GNU GENERAL PUBLIC LICENSE Version 2, June 1991</p> <p>Copyright (C) 1989, 1991 Free Software Foundation, Inc. 59 Temple Place, Suite 330, Boston, MA 02111-1307 USA Everyone is permitted to copy and distribute verbatim copies of this license document, but changing it is not allowed.</p>
net-snmp	<p>Various copyrights apply to this package, listed in various separate parts below. Please make sure that you read all the parts.</p> <p>---- Part 1: CMU/UCD copyright notice: (BSD like) ----</p> <p>Copyright 1989, 1991, 1992 by Carnegie Mellon University</p> <p>Derivative Work - 1996, 1998-2000 Copyright 1996, 1998-2000 The Regents of the University of California</p> <p>All Rights Reserved</p> <p>Permission to use, copy, modify and distribute this software and its documentation for any purpose and without fee is hereby granted, provided that the above copyright notice appears in all copies and that both that copyright notice and this permission notice appear in supporting documentation, and that the name of CMU and The Regents of the University of California not be used in advertising or publicity pertaining to distribution of the software without specific written permission.</p> <p>CMU AND THE REGENTS OF THE UNIVERSITY OF CALIFORNIA DISCLAIM ALL WARRANTIES WITH REGARD TO THIS SOFTWARE, INCLUDING ALL IMPLIED WARRANTIES OF MERCHANTABILITY AND FITNESS. IN NO EVENT SHALL CMU OR THE REGENTS OF THE UNIVERSITY OF CALIFORNIA BE LIABLE FOR ANY SPECIAL, INDIRECT OR CONSEQUENTIAL DAMAGES OR ANY DAMAGES WHATSOEVER RESULTING FROM THE LOSS OF USE, DATA OR PROFITS, WHETHER IN AN ACTION OF</p>

CONTRACT, NEGLIGENCE OR OTHER TORTIOUS ACTION, ARISING OUT OF OR IN CONNECTION WITH THE USE OR PERFORMANCE OF THIS SOFTWARE.  
 ---- Part 2: Networks Associates Technology, Inc copyright notice (BSD) ----

Copyright (c) 2001-2003, Networks Associates Technology, Inc  
 All rights reserved.

Redistribution and use in source and binary forms, with or without modification, are permitted provided that the following conditions are met:

- \* Redistributions of source code must retain the above copyright notice, this list of conditions and the following disclaimer.
- \* Redistributions in binary form must reproduce the above copyright notice, this list of conditions and the following disclaimer in the documentation and/or other materials provided with the distribution.
- \* Neither the name of the Networks Associates Technology, Inc nor the names of its contributors may be used to endorse or promote products derived from this software without specific prior written permission.

THIS SOFTWARE IS PROVIDED BY THE COPYRIGHT HOLDERS AND CONTRIBUTORS "AS IS" AND ANY EXPRESS OR IMPLIED WARRANTIES, INCLUDING, BUT NOT LIMITED TO, THE IMPLIED WARRANTIES OF MERCHANTABILITY AND FITNESS FOR A PARTICULAR PURPOSE ARE DISCLAIMED. IN NO EVENT SHALL THE COPYRIGHT HOLDERS OR CONTRIBUTORS BE LIABLE FOR ANY DIRECT, INDIRECT, INCIDENTAL, SPECIAL, EXEMPLARY, OR CONSEQUENTIAL DAMAGES (INCLUDING, BUT NOT LIMITED TO, PROCUREMENT OF SUBSTITUTE GOODS OR SERVICES; LOSS OF USE, DATA, OR PROFITS; OR BUSINESS INTERRUPTION) HOWEVER CAUSED AND ON ANY THEORY OF LIABILITY, WHETHER IN CONTRACT, STRICT LIABILITY, OR TORT (INCLUDING NEGLIGENCE OR OTHERWISE) ARISING IN ANY WAY OUT OF THE USE OF THIS SOFTWARE, EVEN IF ADVISED OF THE POSSIBILITY OF SUCH DAMAGE.

---- Part 3: Cambridge Broadband Ltd. copyright notice (BSD) ----

Portions of this code are copyright (c) 2001-2003, Cambridge Broadband Ltd.  
 All rights reserved.

Redistribution and use in source and binary forms, with or without modification, are permitted provided that the following conditions are met:

- \* Redistributions of source code must retain the above copyright notice, this list of conditions and the following disclaimer.
- \* Redistributions in binary form must reproduce the above copyright notice, this list of conditions and the following disclaimer in the documentation and/or other materials provided with the distribution.
- \* The name of Cambridge Broadband Ltd. may not be used to endorse or



promote products derived from this software without specific prior written permission.

THIS SOFTWARE IS PROVIDED BY THE COPYRIGHT HOLDER ``AS IS" AND ANY EXPRESS OR IMPLIED WARRANTIES, INCLUDING, BUT NOT LIMITED TO, THE IMPLIED WARRANTIES OF MERCHANTABILITY AND FITNESS FOR A PARTICULAR PURPOSE ARE DISCLAIMED. IN NO EVENT SHALL THE COPYRIGHT HOLDER BE LIABLE FOR ANY DIRECT, INDIRECT, INCIDENTAL, SPECIAL, EXEMPLARY, OR CONSEQUENTIAL DAMAGES (INCLUDING, BUT NOT LIMITED TO, PROCUREMENT OF SUBSTITUTE GOODS OR SERVICES; LOSS OF USE, DATA, OR PROFITS; OR BUSINESS INTERRUPTION) HOWEVER CAUSED AND ON ANY THEORY OF LIABILITY, WHETHER IN CONTRACT, STRICT LIABILITY, OR TORT (INCLUDING NEGLIGENCE OR OTHERWISE) ARISING IN ANY WAY OUT OF THE USE OF THIS SOFTWARE, EVEN IF ADVISED OF THE POSSIBILITY OF SUCH DAMAGE.

---- Part 4: Sun Microsystems, Inc. copyright notice (BSD) ----

Copyright © 2003 Sun Microsystems, Inc., 4150 Network Circle, Santa Clara, California 95054, U.S.A. All rights reserved.

Use is subject to license terms below.

This distribution may include materials developed by third parties.

Sun, Sun Microsystems, the Sun logo and Solaris are trademarks or registered trademarks of Sun Microsystems, Inc. in the U.S. and other countries.

Redistribution and use in source and binary forms, with or without modification, are permitted provided that the following conditions are met:

- \* Redistributions of source code must retain the above copyright notice, this list of conditions and the following disclaimer.
- \* Redistributions in binary form must reproduce the above copyright notice, this list of conditions and the following disclaimer in the documentation and/or other materials provided with the distribution.
- \* Neither the name of the Sun Microsystems, Inc. nor the names of its contributors may be used to endorse or promote products derived from this software without specific prior written permission.

THIS SOFTWARE IS PROVIDED BY THE COPYRIGHT HOLDERS AND CONTRIBUTORS ``AS IS" AND ANY EXPRESS OR IMPLIED WARRANTIES, INCLUDING, BUT NOT LIMITED TO, THE IMPLIED WARRANTIES OF MERCHANTABILITY AND FITNESS FOR A PARTICULAR PURPOSE ARE DISCLAIMED. IN NO EVENT SHALL THE COPYRIGHT HOLDERS OR CONTRIBUTORS BE LIABLE FOR ANY DIRECT, INDIRECT, INCIDENTAL,

SPECIAL,  
 EXEMPLARY, OR CONSEQUENTIAL DAMAGES (INCLUDING, BUT NOT  
 LIMITED TO,  
 PROCUREMENT OF SUBSTITUTE GOODS OR SERVICES; LOSS OF USE,  
 DATA, OR PROFITS;  
 OR BUSINESS INTERRUPTION) HOWEVER CAUSED AND ON ANY  
 THEORY OF LIABILITY,  
 WHETHER IN CONTRACT, STRICT LIABILITY, OR TORT (INCLUDING  
 NEGLIGENCE OR  
 OTHERWISE) ARISING IN ANY WAY OUT OF THE USE OF THIS  
 SOFTWARE, EVEN IF  
 ADVISED OF THE POSSIBILITY OF SUCH DAMAGE.  
 ---- Part 5: Sparta, Inc copyright notice (BSD) ----

Copyright (c) 2003-2011, Sparta, Inc  
 All rights reserved.

Redistribution and use in source and binary forms, with or without  
 modification, are permitted provided that the following conditions are met:

- \* Redistributions of source code must retain the above copyright notice,  
 this list of conditions and the following disclaimer.
- \* Redistributions in binary form must reproduce the above copyright  
 notice, this list of conditions and the following disclaimer in the  
 documentation and/or other materials provided with the distribution.
- \* Neither the name of Sparta, Inc nor the names of its contributors may  
 be used to endorse or promote products derived from this software  
 without specific prior written permission.

THIS SOFTWARE IS PROVIDED BY THE COPYRIGHT HOLDERS AND  
 CONTRIBUTORS "AS  
 IS" AND ANY EXPRESS OR IMPLIED WARRANTIES, INCLUDING, BUT  
 NOT LIMITED TO,  
 THE IMPLIED WARRANTIES OF MERCHANTABILITY AND FITNESS FOR A  
 PARTICULAR  
 PURPOSE ARE DISCLAIMED. IN NO EVENT SHALL THE COPYRIGHT  
 HOLDERS OR  
 CONTRIBUTORS BE LIABLE FOR ANY DIRECT, INDIRECT, INCIDENTAL,  
 SPECIAL,  
 EXEMPLARY, OR CONSEQUENTIAL DAMAGES (INCLUDING, BUT NOT  
 LIMITED TO,  
 PROCUREMENT OF SUBSTITUTE GOODS OR SERVICES; LOSS OF USE,  
 DATA, OR PROFITS;  
 OR BUSINESS INTERRUPTION) HOWEVER CAUSED AND ON ANY  
 THEORY OF LIABILITY,  
 WHETHER IN CONTRACT, STRICT LIABILITY, OR TORT (INCLUDING  
 NEGLIGENCE OR  
 OTHERWISE) ARISING IN ANY WAY OUT OF THE USE OF THIS  
 SOFTWARE, EVEN IF  
 ADVISED OF THE POSSIBILITY OF SUCH DAMAGE.  
 ---- Part 6: Cisco/BUPTNIC copyright notice (BSD) ----

Copyright (c) 2004, Cisco, Inc and Information Network  
 Center of Beijing University of Posts and Telecommunications.  
 All rights reserved.

Redistribution and use in source and binary forms, with or without  
 modification, are permitted provided that the following conditions are met:

- \* Redistributions of source code must retain the above copyright notice, this list of conditions and the following disclaimer.
- \* Redistributions in binary form must reproduce the above copyright notice, this list of conditions and the following disclaimer in the documentation and/or other materials provided with the distribution.
- \* Neither the name of Cisco, Inc, Beijing University of Posts and Telecommunications, nor the names of their contributors may be used to endorse or promote products derived from this software without specific prior written permission.

THIS SOFTWARE IS PROVIDED BY THE COPYRIGHT HOLDERS AND CONTRIBUTORS "AS IS" AND ANY EXPRESS OR IMPLIED WARRANTIES, INCLUDING, BUT NOT LIMITED TO, THE IMPLIED WARRANTIES OF MERCHANTABILITY AND FITNESS FOR A PARTICULAR PURPOSE ARE DISCLAIMED. IN NO EVENT SHALL THE COPYRIGHT HOLDERS OR CONTRIBUTORS BE LIABLE FOR ANY DIRECT, INDIRECT, INCIDENTAL, SPECIAL, EXEMPLARY, OR CONSEQUENTIAL DAMAGES (INCLUDING, BUT NOT LIMITED TO, PROCUREMENT OF SUBSTITUTE GOODS OR SERVICES; LOSS OF USE, DATA, OR PROFITS; OR BUSINESS INTERRUPTION) HOWEVER CAUSED AND ON ANY THEORY OF LIABILITY, WHETHER IN CONTRACT, STRICT LIABILITY, OR TORT (INCLUDING NEGLIGENCE OR OTHERWISE) ARISING IN ANY WAY OUT OF THE USE OF THIS SOFTWARE, EVEN IF ADVISED OF THE POSSIBILITY OF SUCH DAMAGE.

---- Part 7: Fabasoft R&D Software GmbH & Co KG copyright notice (BSD) ----

Copyright (c) Fabasoft R&D Software GmbH & Co KG, 2003  
 oss@fabasoft.com  
 Author: Bernhard Penz <bernhard.penz@fabasoft.com>

Redistribution and use in source and binary forms, with or without modification, are permitted provided that the following conditions are met:

- \* Redistributions of source code must retain the above copyright notice, this list of conditions and the following disclaimer.
- \* Redistributions in binary form must reproduce the above copyright notice, this list of conditions and the following disclaimer in the documentation and/or other materials provided with the distribution.
- \* The name of Fabasoft R&D Software GmbH & Co KG or any of its subsidiaries, brand or product names may not be used to endorse or promote products derived from this software without specific prior written permission.

THIS SOFTWARE IS PROVIDED BY THE COPYRIGHT HOLDER "AS IS" AND ANY EXPRESS OR IMPLIED WARRANTIES, INCLUDING, BUT NOT LIMITED TO, THE IMPLIED WARRANTIES OF MERCHANTABILITY AND FITNESS FOR A

	<p>PARTICULAR PURPOSE ARE DISCLAIMED. IN NO EVENT SHALL THE COPYRIGHT HOLDER BE LIABLE FOR ANY DIRECT, INDIRECT, INCIDENTAL, SPECIAL, EXEMPLARY, OR CONSEQUENTIAL DAMAGES (INCLUDING, BUT NOT LIMITED TO, PROCUREMENT OF SUBSTITUTE GOODS OR SERVICES; LOSS OF USE, DATA, OR PROFITS; OR BUSINESS INTERRUPTION) HOWEVER CAUSED AND ON ANY THEORY OF LIABILITY, WHETHER IN CONTRACT, STRICT LIABILITY, OR TORT (INCLUDING NEGLIGENCE OR OTHERWISE) ARISING IN ANY WAY OUT OF THE USE OF THIS SOFTWARE, EVEN IF ADVISED OF THE POSSIBILITY OF SUCH DAMAGE.</p>
odhcp6c	<p>GNU GENERAL PUBLIC LICENSE Version 2, June 1991</p> <p>Copyright (C) 1989, 1991 Free Software Foundation, Inc. 51 Franklin St, Fifth Floor, Boston, MA 02110-1301 USA Everyone is permitted to copy and distribute verbatim copies of this license document, but changing it is not allowed.</p>
odhcpd	<p>GNU GENERAL PUBLIC LICENSE Version 2, June 1991</p> <p>Copyright (C) 1989, 1991 Free Software Foundation, Inc. 51 Franklin St, Fifth Floor, Boston, MA 02110-1301 USA Everyone is permitted to copy and distribute verbatim copies of this license document, but changing it is not allowed.</p>
openssl	<p>LICENSE ISSUES =====</p> <p>The OpenSSL toolkit stays under a double license, i.e. both the conditions of the OpenSSL License and the original SSLeay license apply to the toolkit. See below for the actual license texts. Actually both licenses are BSD-style Open Source licenses. In case of any license issues related to OpenSSL please contact openssl-core@openssl.org.</p> <p>OpenSSL License -----</p> <p>/* =====</p> <p>===== * Copyright (c) 1998-2017 The OpenSSL Project. All rights reserved. * * Redistribution and use in source and binary forms, with or without * modification, are permitted provided that the following conditions * are met: * * 1. Redistributions of source code must retain the above copyright * notice, this list of conditions and the following disclaimer. * * 2. Redistributions in binary form must reproduce the above copyright * notice, this list of conditions and the following disclaimer in * the documentation and/or other materials provided with the * distribution.</p>

```

*
* 3. All advertising materials mentioning features or use of this
* software must display the following acknowledgment:
* "This product includes software developed by the OpenSSL Project
* for use in the OpenSSL Toolkit. (http://www.openssl.org/)"
*
* 4. The names "OpenSSL Toolkit" and "OpenSSL Project" must not be used
to
* endorse or promote products derived from this software without
* prior written permission. For written permission, please contact
* openssl-core@openssl.org.
*
* 5. Products derived from this software may not be called "OpenSSL"
* nor may "OpenSSL" appear in their names without prior written
* permission of the OpenSSL Project.
*
* 6. Redistributions of any form whatsoever must retain the following
* acknowledgment:
* "This product includes software developed by the OpenSSL Project
* for use in the OpenSSL Toolkit (http://www.openssl.org/)"
*
* THIS SOFTWARE IS PROVIDED BY THE OpenSSL PROJECT ``AS IS''
AND ANY
* EXPRESSED OR IMPLIED WARRANTIES, INCLUDING, BUT NOT
LIMITED TO, THE
* IMPLIED WARRANTIES OF MERCHANTABILITY AND FITNESS FOR A
PARTICULAR
* PURPOSE ARE DISCLAIMED. IN NO EVENT SHALL THE OpenSSL
PROJECT OR
* ITS CONTRIBUTORS BE LIABLE FOR ANY DIRECT, INDIRECT,
INCIDENTAL,
* SPECIAL, EXEMPLARY, OR CONSEQUENTIAL DAMAGES (INCLUDING,
BUT
* NOT LIMITED TO, PROCUREMENT OF SUBSTITUTE GOODS OR
SERVICES;
* LOSS OF USE, DATA, OR PROFITS; OR BUSINESS INTERRUPTION)
* HOWEVER CAUSED AND ON ANY THEORY OF LIABILITY, WHETHER IN
CONTRACT,
* STRICT LIABILITY, OR TORT (INCLUDING NEGLIGENCE OR
OTHERWISE)
* ARISING IN ANY WAY OUT OF THE USE OF THIS SOFTWARE, EVEN IF
ADVISED
* OF THE POSSIBILITY OF SUCH DAMAGE.
*
=====
=====
*
* This product includes cryptographic software written by Eric Young
* (eay@cryptsoft.com). This product includes software written by Tim
* Hudson (tjh@cryptsoft.com).
*
*/

Original SSLeay License
-----
/* Copyright (C) 1995-1998 Eric Young (eay@cryptsoft.com)
* All rights reserved.
*
* This package is an SSL implementation written
* by Eric Young (eay@cryptsoft.com).

```

\* The implementation was written so as to conform with Netscapes SSL.  
\*  
\* This library is free for commercial and non-commercial use as long as  
\* the following conditions are aheared to. The following conditions  
\* apply to all code found in this distribution, be it the RC4, RSA,  
\* lhash, DES, etc., code; not just the SSL code. The SSL documentation  
\* included with this distribution is covered by the same copyright terms  
\* except that the holder is Tim Hudson (tjh@cryptsoft.com).  
\*  
\* Copyright remains Eric Young's, and as such any Copyright notices in  
\* the code are not to be removed.  
\* If this package is used in a product, Eric Young should be given attribution  
\* as the author of the parts of the library used.  
\* This can be in the form of a textual message at program startup or  
\* in documentation (online or textual) provided with the package.  
\*  
\* Redistribution and use in source and binary forms, with or without  
\* modification, are permitted provided that the following conditions  
\* are met:  
\* 1. Redistributions of source code must retain the copyright  
\* notice, this list of conditions and the following disclaimer.  
\* 2. Redistributions in binary form must reproduce the above copyright  
\* notice, this list of conditions and the following disclaimer in the  
\* documentation and/or other materials provided with the distribution.  
\* 3. All advertising materials mentioning features or use of this software  
\* must display the following acknowledgement:  
\* "This product includes cryptographic software written by  
\* Eric Young (eay@cryptsoft.com)"  
\* The word 'cryptographic' can be left out if the rouines from the library  
\* being used are not cryptographic related :-).  
\* 4. If you include any Windows specific code (or a derivative thereof) from  
\* the apps directory (application code) you must include an  
acknowledgement:  
\* "This product includes software written by Tim Hudson  
(tjh@cryptsoft.com)"  
\*  
\* THIS SOFTWARE IS PROVIDED BY ERIC YOUNG ``AS IS" AND  
\* ANY EXPRESS OR IMPLIED WARRANTIES, INCLUDING, BUT NOT  
LIMITED TO, THE  
\* IMPLIED WARRANTIES OF MERCHANTABILITY AND FITNESS FOR A  
PARTICULAR PURPOSE  
\* ARE DISCLAIMED. IN NO EVENT SHALL THE AUTHOR OR  
CONTRIBUTORS BE LIABLE  
\* FOR ANY DIRECT, INDIRECT, INCIDENTAL, SPECIAL, EXEMPLARY, OR  
CONSEQUENTIAL  
\* DAMAGES (INCLUDING, BUT NOT LIMITED TO, PROCUREMENT OF  
SUBSTITUTE GOODS  
\* OR SERVICES; LOSS OF USE, DATA, OR PROFITS; OR BUSINESS  
INTERRUPTION)  
\* HOWEVER CAUSED AND ON ANY THEORY OF LIABILITY, WHETHER IN  
CONTRACT, STRICT  
\* LIABILITY, OR TORT (INCLUDING NEGLIGENCE OR OTHERWISE)  
ARISING IN ANY WAY  
\* OUT OF THE USE OF THIS SOFTWARE, EVEN IF ADVISED OF THE  
POSSIBILITY OF  
\* SUCH DAMAGE.  
\*  
\* The licence and distribution terms for any publically available version or  
\* derivative of this code cannot be changed. i.e. this code cannot simply be  
\* copied and put under another distribution licence

	<p>* [including the GNU Public Licence.] */</p>
opkg	<p>GNU GENERAL PUBLIC LICENSE Version 2, June 1991</p> <p>Copyright (C) 1989, 1991 Free Software Foundation, Inc. 59 Temple Place, Suite 330, Boston, MA 02111-1307 USA Everyone is permitted to copy and distribute verbatim copies of this license document, but changing it is not allowed.</p>
pcre	<p>Release 8 of PCRE is distributed under the terms of the "BSD" licence, as specified below. The documentation for PCRE, supplied in the "doc" directory, is distributed under the same terms as the software itself.</p> <p>THE MAIN PCRE LIBRARY ----- Written by: Philip Hazel Email local part: ph10 Email domain: cam.ac.uk University of Cambridge Computing Service, Cambridge, England. Copyright (c) 1997-2010 University of Cambridge All rights reserved</p> <p>THE C++ WRAPPER LIBRARY ----- Written by: Google Inc. Copyright (c) 2007-2010 Google Inc All rights reserved</p>
pm-utils	<p>GNU GENERAL PUBLIC LICENSE Version 2, June 1991</p> <p>Copyright (C) 1989, 1991 Free Software Foundation, Inc. 59 Temple Place, Suite 330, Boston, MA 02111-1307 USA Everyone is permitted to copy and distribute verbatim copies of this license document, but changing it is not allowed.</p> <p>/* * suspend functions for machines with Mac-style pmu * * Copyright 2006 Red Hat, Inc. * * Based on work from: * Peter Jones &lt;pjones@redhat.com&gt; * * This program is free software; you can redistribute it and/or modify * it under the terms of version 2 of the GNU General Public License as * published by the Free Software Foundation. * * This program is distributed in the hope that it will be useful, * but WITHOUT ANY WARRANTY; without even the implied warranty of * MERCHANTABILITY or FITNESS FOR A PARTICULAR PURPOSE. See the * GNU General Public License for more details. * * You should have received a copy of the GNU General Public License * along with this program; if not, write to the Free Software * Foundation, Inc., 59 Temple Place, Suite 330, Boston, MA 02111-1307 USA</p>

	<pre> * */ </pre>
ppp	
rng-tools	<pre> GNU GENERAL PUBLIC LICENSE Version 2, June 1991  Copyright (C) 1989, 1991 Free Software Foundation, Inc.   51 Franklin Street, Suite 500, Boston, MA 02110-1335 USA Everyone is permitted to copy and distribute verbatim copies of this license document, but changing it is not allowed. * rngd.c -- Random Number Generator daemon * * rngd reads data from a hardware random number generator, verifies it * looks like random data, and adds it to /dev/random's entropy store. * * In theory, this should allow you to read very quickly from * /dev/random; rngd also adds bytes to the entropy store periodically * when it's full, which makes predicting the entropy store's contents * harder. * * Copyright (C) 2001 Philipp Rumpf * * This program is free software; you can redistribute it and/or modify * it under the terms of the GNU General Public License as published by * the Free Software Foundation; either version 2 of the License, or * (at your option) any later version. * * This program is distributed in the hope that it will be useful, * but WITHOUT ANY WARRANTY; without even the implied warranty of * MERCHANTABILITY or FITNESS FOR A PARTICULAR PURPOSE. See the * GNU General Public License for more details. * * You should have received a copy of the GNU General Public License * along with this program; if not, write to the Free Software * Foundation, Inc., 51 Franklin Street, Suite 500, Boston, MA 02110-1335 USA */ </pre>
rp-pppoe	<pre> GNU GENERAL PUBLIC LICENSE Version 2, June 1991  Copyright (C) 1989, 1991 Free Software Foundation, Inc.   675 Mass Ave, Cambridge, MA 02139, USA Everyone is permitted to copy and distribute verbatim copies of this license document, but changing it is not allowed. /***** * * pppoe.c * * Implementation of user-space PPPoE redirector for Linux. * * Copyright (C) 2000-2012 by Roaring Penguin Software Inc. * * This program may be distributed according to the terms of the GNU * General Public License, version 2 or (at your option) any later version. </pre>



	<p>* * LIC: GPL</p>
rstp	<p style="text-align: center;">GNU GENERAL PUBLIC LICENSE Version 2, June 1991</p> <p>Copyright (C) 1989, 1991 Free Software Foundation, Inc. 51 Franklin St, Fifth Floor, Boston, MA 02110-1301 USA Everyone is permitted to copy and distribute verbatim copies of this license document, but changing it is not allowed. /***** Copyright (c) 2006 EMC Corporation.</p> <p>This program is free software; you can redistribute it and/or modify it under the terms of the GNU General Public License as published by the Free Software Foundation; either version 2 of the License, or (at your option) any later version.</p> <p>This program is distributed in the hope that it will be useful, but WITHOUT ANY WARRANTY; without even the implied warranty of MERCHANTABILITY or FITNESS FOR A PARTICULAR PURPOSE. See the GNU General Public License for more details.</p> <p>You should have received a copy of the GNU General Public License along with this program; if not, write to the Free Software Foundation, Inc., 59 Temple Place - Suite 330, Boston, MA 02111-1307, USA.</p> <p>The full GNU General Public License is included in this distribution in the file called LICENSE.</p> <p>Authors: Srinivas Aji &lt;Aji_Srinivas@emc.com&gt;</p>
squashfs	<p style="text-align: center;">GNU GENERAL PUBLIC LICENSE Version 2, June 1991</p> <p>Copyright (C) 1989, 1991 Free Software Foundation, Inc. 59 Temple Place, Suite 330, Boston, MA 02111-1307 USA Everyone is permitted to copy and distribute verbatim copies of this license document, but changing it is not allowed. * Squashfs * * Copyright (c) 2002, 2003, 2004, 2005, 2006, 2007, 2008, 2009 * Phillip Lougher &lt;phillip@lougher.demon.co.uk&gt; * * This program is free software; you can redistribute it and/or * modify it under the terms of the GNU General Public License * as published by the Free Software Foundation; either version 2, * or (at your option) any later version. * * This program is distributed in the hope that it will be useful, * but WITHOUT ANY WARRANTY; without even the implied warranty of * MERCHANTABILITY or FITNESS FOR A PARTICULAR PURPOSE. See the * GNU General Public License for more details. * * You should have received a copy of the GNU General Public License</p>

	<p>* along with this program; if not, write to the Free Software  * Foundation, 59 Temple Place - Suite 330, Boston, MA 02111-1307, USA.</p>
strace	<pre> /*  * Copyright (c) 1991, 1992 Paul Kranenburg &lt;pk@cs.few.eur.nl&gt;  * Copyright (c) 1993 Branko Lankester &lt;branko@hacktic.nl&gt;  * Copyright (c) 1993, 1994, 1995, 1996 Rick Sladkey &lt;jrs@world.std.com&gt;  * Copyright (c) 1996-1999 Wichert Akkerman &lt;wichert@cistron.nl&gt;  * All rights reserved.  *  * Redistribution and use in source and binary forms, with or without  * modification, are permitted provided that the following conditions  * are met:  * 1. Redistributions of source code must retain the above copyright  * notice, this list of conditions and the following disclaimer.  * 2. Redistributions in binary form must reproduce the above copyright  * notice, this list of conditions and the following disclaimer in the  * documentation and/or other materials provided with the distribution.  * 3. The name of the author may not be used to endorse or promote products  * derived from this software without specific prior written permission.  *  * THIS SOFTWARE IS PROVIDED BY THE AUTHOR ``AS IS" AND ANY  * EXPRESS OR  * IMPLIED WARRANTIES, INCLUDING, BUT NOT LIMITED TO, THE  * IMPLIED WARRANTIES  * OF MERCHANTABILITY AND FITNESS FOR A PARTICULAR PURPOSE  * ARE DISCLAIMED.  * IN NO EVENT SHALL THE AUTHOR BE LIABLE FOR ANY DIRECT,  * INDIRECT,  * INCIDENTAL, SPECIAL, EXEMPLARY, OR CONSEQUENTIAL DAMAGES  * (INCLUDING, BUT  * NOT LIMITED TO, PROCUREMENT OF SUBSTITUTE GOODS OR  * SERVICES; LOSS OF USE,  * DATA, OR PROFITS; OR BUSINESS INTERRUPTION) HOWEVER  * CAUSED AND ON ANY  * THEORY OF LIABILITY, WHETHER IN CONTRACT, STRICT LIABILITY,  * OR TORT  * (INCLUDING NEGLIGENCE OR OTHERWISE) ARISING IN ANY WAY OUT  * OF THE USE OF  * THIS SOFTWARE, EVEN IF ADVISED OF THE POSSIBILITY OF SUCH  * DAMAGE.  */ </pre>
syslog-ng	<p>Copyright (c) 2002-2015 Balabit  Copyright (c) 1996-2015 Balázs Scheidler</p> <p>syslog-ng is licensed under the combination of the GPL and LGPL licenses.</p> <p>The syslog-ng core contained in the following subdirectories is free software; you can redistribute it and/or modify it under the terms of the GNU Lesser General Public License as published by the Free Software Foundation; either version 2.1 of the License, or (at your option) any later version (please refer to the file LGPL.txt for more details):</p> <pre> lib/ libtest/ syslog-ng/ modules/java-common/ modules/java/(native proxies src)/ </pre>

	<p>modules/native/  This library is free software; you can redistribute it and/or modify it under the terms of the GNU Lesser General Public License as published by the Free Software Foundation; either version 2.1 of the License, or (at your option) any later version.</p> <p>This library is distributed in the hope that it will be useful, but WITHOUT ANY WARRANTY; without even the implied warranty of MERCHANTABILITY or FITNESS FOR A PARTICULAR PURPOSE. See the GNU Lesser General Public License for more details.</p> <p>You should have received a copy of the GNU Lesser General Public License along with this library; if not, write to the Free Software Foundation, Inc., 51 Franklin St, Fifth Floor, Boston, MA 02110-1301 USA</p>
sysstat	<p>GNU GENERAL PUBLIC LICENSE  Version 2, June 1991</p> <p>Copyright (C) 1989, 1991 Free Software Foundation, Inc.  675 Mass Ave, Cambridge, MA 02139, USA  Everyone is permitted to copy and distribute verbatim copies of this license document, but changing it is not allowed.  * (C) 1998-2015 by Sebastien GODARD (sysstat &lt;at&gt; orange.fr)  *  *****  * This program is free software; you can redistribute it and/or modify it *  * under the terms of the GNU General Public License as published by the *  * Free Software Foundation; either version 2 of the License, or (at your *  * option) any later version. *  * *  * This program is distributed in the hope that it will be useful, but *  * WITHOUT ANY WARRANTY; without the implied warranty of  MERCHANTABILITY *  * or FITNESS FOR A PARTICULAR PURPOSE. See the GNU General Public  License *  * for more details. *  * *  * You should have received a copy of the GNU General Public License along *  * with this program; if not, write to the Free Software Foundation, Inc., *  * 59 Temple Place, Suite 330, Boston, MA 02111-1307 USA *  *****  */</p>
tcpdump	<p>License: BSD</p> <p>Redistribution and use in source and binary forms, with or without modification, are permitted provided that the following conditions are met:</p> <ol style="list-style-type: none"> <li>1. Redistributions of source code must retain the above copyright notice, this list of conditions and the following disclaimer.</li> <li>2. Redistributions in binary form must reproduce the above copyright notice, this list of conditions and the following disclaimer in the documentation and/or other materials provided with the distribution.</li> <li>3. The names of the authors may not be used to endorse or promote products derived from this software without specific prior written permission.</li> </ol> <p>THIS SOFTWARE IS PROVIDED ``AS IS'' AND WITHOUT ANY EXPRESS</p>

	<pre> OR IMPLIED WARRANTIES, INCLUDING, WITHOUT LIMITATION, THE IMPLIED WARRANTIES OF MERCHANTABILITY AND FITNESS FOR A PARTICULAR PURPOSE. /*  * Copyright (c) 1988, 1989, 1990, 1991, 1992, 1993, 1994, 1995, 1996, 1997, 2000  *   The Regents of the University of California. All rights reserved.  *  * Redistribution and use in source and binary forms, with or without  * modification, are permitted provided that: (1) source code distributions  * retain the above copyright notice and this paragraph in its entirety, (2)  * distributions including binary code include the above copyright notice and  * this paragraph in its entirety in the documentation or other materials  * provided with the distribution, and (3) all advertising materials mentioning  * features or use of this software display the following acknowledgement:  * ``This product includes software developed by the University of California,  * Lawrence Berkeley Laboratory and its contributors." Neither the name of  * the University nor the names of its contributors may be used to endorse  * or promote products derived from this software without specific prior  * written permission.  * THIS SOFTWARE IS PROVIDED ``AS IS" AND WITHOUT ANY EXPRESS OR IMPLIED  * WARRANTIES, INCLUDING, WITHOUT LIMITATION, THE IMPLIED WARRANTIES OF  * MERCHANTABILITY AND FITNESS FOR A PARTICULAR PURPOSE.  *  * Support for splitting captures into multiple files with a maximum  * file size:  *  * Copyright (c) 2001  *   Seth Webster &lt;swebster@sst.ll.mit.edu&gt;  */ </pre>
trace-cmd	<pre> GNU GENERAL PUBLIC LICENSE Version 2, June 1991  Copyright (C) 1989, 1991 Free Software Foundation, Inc., 51 Franklin Street, Fifth Floor, Boston, MA 02110-1301 USA Everyone is permitted to copy and distribute verbatim copies of this license document, but changing it is not allowed. The applications are licensed under the GNU General Public License 2.0 (see COPYING) and the libraries are licensed under the GNU Lesser General Public License 2.1 (See COPYING.LIB). </pre>
ubi-utils	<pre> GNU GENERAL PUBLIC LICENSE Version 2, June 1991  Copyright (C) 1989, 1991 Free Software Foundation, Inc. 59 Temple Place, Suite 330, Boston, MA 02111-1307 USA Everyone is permitted to copy and distribute verbatim copies of this license document, but changing it is not allowed. /*  * Copyright (c) International Business Machines Corp., 2006  *  * This program is free software; you can redistribute it and/or modify  * it under the terms of the GNU General Public License as published by  * the Free Software Foundation; either version 2 of the License, or  * (at your option) any later version.  *  * This program is distributed in the hope that it will be useful, </pre>

```
* but WITHOUT ANY WARRANTY; without even the implied warranty of
* MERCHANTABILITY or FITNESS FOR A PARTICULAR PURPOSE. See
* the GNU General Public License for more details.
```

```
*
```

```
* You should have received a copy of the GNU General Public License
* along with this program; if not, write to the Free Software
* Foundation, Inc., 675 Mass Ave, Cambridge, MA 02139, USA.
```

```
*/
```

```
/*
```

```
* An utility to create UBI volumes.
```

```
*
```

```
* Authors: Artem Bityutskiy <dedekind@infradead.org>
```

```
*          Frank Haverkamp <haver@vnet.ibm.com>
```

```
*/
```

Copyright (c) 2000-2007 by Nicolas Devillard.

MIT License

Permission is hereby granted, free of charge, to any person obtaining a copy of this software and associated documentation files (the "Software"), to deal in the Software without restriction, including without limitation the rights to use, copy, modify, merge, publish, distribute, sublicense, and/or sell copies of the Software, and to permit persons to whom the Software is furnished to do so, subject to the following conditions:

The above copyright notice and this permission notice shall be included in all copies or substantial portions of the Software.

THE SOFTWARE IS PROVIDED "AS IS", WITHOUT WARRANTY OF ANY KIND, EXPRESS OR IMPLIED, INCLUDING BUT NOT LIMITED TO THE WARRANTIES OF MERCHANTABILITY, FITNESS FOR A PARTICULAR PURPOSE AND NONINFRINGEMENT. IN NO EVENT SHALL THE AUTHORS OR COPYRIGHT HOLDERS BE LIABLE FOR ANY CLAIM, DAMAGES OR OTHER LIABILITY, WHETHER IN AN ACTION OF CONTRACT, TORT OR OTHERWISE, ARISING FROM, OUT OF OR IN CONNECTION WITH THE SOFTWARE OR THE USE OR OTHER DEALINGS IN THE SOFTWARE.

uClibc-ng	<p>GNU LESSER GENERAL PUBLIC LICENSE Version 2.1, February 1999</p> <p>Copyright (C) 1991, 1999 Free Software Foundation, Inc. 51 Franklin St, Fifth Floor, Boston, MA 02110-1301 USA Everyone is permitted to copy and distribute verbatim copies of this license document, but changing it is not allowed.</p> <p>[This is the first released version of the Lesser GPL. It also counts as the successor of the GNU Library Public License, version 2, hence the version number 2.1.]</p>
wget	<p>GNU GENERAL PUBLIC LICENSE Version 2, June 1991</p> <p>Copyright (C) 1989, 1991 Free Software Foundation, Inc. 51 Franklin St, Fifth Floor, Boston, MA 02110-1301 USA Everyone is permitted to copy and distribute verbatim copies</p>

	<p>of this license document, but changing it is not allowed.</p> <p>/* Miscellaneous declarations.  Copyright (C) 1995, 1996, 1997, 1998, 2003 Free Software Foundation, Inc.</p> <p>This file is part of GNU Wget.</p> <p>GNU Wget is free software; you can redistribute it and/or modify it under the terms of the GNU General Public License as published by the Free Software Foundation; either version 2 of the License, or (at your option) any later version.</p> <p>GNU Wget is distributed in the hope that it will be useful, but WITHOUT ANY WARRANTY; without even the implied warranty of MERCHANTABILITY or FITNESS FOR A PARTICULAR PURPOSE. See the GNU General Public License for more details.</p> <p>You should have received a copy of the GNU General Public License along with Wget; if not, write to the Free Software Foundation, Inc., 675 Mass Ave, Cambridge, MA 02139, USA.</p> <p>In addition, as a special exception, the Free Software Foundation gives permission to link the code of its release of Wget with the OpenSSL project's "OpenSSL" library (or with modified versions of it that use the same license as the "OpenSSL" library), and distribute the linked executables. You must obey the GNU General Public License in all respects for all of the code used other than "OpenSSL". If you modify this file, you may extend this exception to your version of the file, but you are not obligated to do so. If you do not wish to do so, delete this exception statement from your version. */</p>
wireless_tools.29	<p>GNU GENERAL PUBLIC LICENSE  Version 2, June 1991</p> <p>Copyright (C) 1989, 1991 Free Software Foundation, Inc.  59 Temple Place, Suite 330, Boston, MA 02111-1307 USA  Everyone is permitted to copy and distribute verbatim copies of this license document, but changing it is not allowed.</p>
xtables-addons	<p>GNU GENERAL PUBLIC LICENSE  Version 2, June 1991</p> <p>Copyright (C) 1989, 1991 Free Software Foundation, Inc.,  51 Franklin Street, Fifth Floor, Boston, MA 02110-1301 USA  Everyone is permitted to copy and distribute verbatim copies of this license document, but changing it is not allowed.</p>
zlib	<p>/* zlib.h -- interface of the 'zlib' general purpose compression library  version 1.2.8, April 28th, 2013</p> <p>Copyright (C) 1995-2013 Jean-loup Gailly and Mark Adler</p> <p>This software is provided 'as-is', without any express or implied warranty. In no event will the authors be held liable for any damages arising from the use of this software.</p> <p>Permission is granted to anyone to use this software for any purpose, including commercial applications, and to alter it and redistribute it freely, subject to the following restrictions:</p> <ol style="list-style-type: none"> <li>1. The origin of this software must not be misrepresented; you must not claim that you wrote the original software. If you use this software in a product, an acknowledgment in the product documentation would be</li> </ol>

appreciated but is not required.

2. Altered source versions must be plainly marked as such, and must not be misrepresented as being the original software.
3. This notice may not be removed or altered from any source distribution.

Jean-loup Gailly  
jloup@gzip.org

Mark Adler  
madler@alumni.caltech.edu

The data format used by the zlib library is described by RFCs (Request for Comments) 1950 to 1952 in the files <http://tools.ietf.org/html/rfc1950> (zlib format), rfc1951 (deflate format) and rfc1952 (gzip format).

\*/

## Compliance with safety standards

This section lists the safety specifications against which the PTP 550 has been tested and certified. It also describes how to keep RF exposure within safe limits.

### Electrical safety compliance

The PTP 550 hardware has been tested for compliance to the electrical safety specifications listed in [Table 40](#).

**Table 28** PTP 550 safety compliance specifications

Region	Standard
USA	UL 60950-1, 2nd Edition; UL60950-22
Canada	CAN/CSA C22.2 No.60950-1-07, 2nd Edition; CAN/CSA C22.2 No.60950-22-07
EU	EN 60950-1:2006 + Amendment 12:2011, EN 60950-22
International	CB certified to IEC 60950-1: 2005 (modified); IEC 60950-22: 2005 (modified)

### Electromagnetic compatibility (EMC) compliance

The PTP 550 complies with European EMC Specification EN301 489-1 with testing carried out to the detailed requirements of EN301 489-4.



**Note**

For EN 61000-4-2: 1995 to 2009 Electro Static Discharge (ESD), Class 2, 8 kV air, 4 kV contact discharge, the PTP 550 has been tested to ensure immunity to 15 kV air and 8 kV contact.

[Table 41](#) lists the EMC specification type approvals that have been granted for PTP 550 products.

**Table 29** EMC emissions compliance

Region	Specification (Type Approvals)
Europe	ETSI EN301 489-4

### Human exposure to radio frequency energy

Relevant standards (USA and EC) applicable when working with RF equipment are:

- ANSI IEEE C95.1-1991, IEEE Standard for Safety Levels with Respect to Human Exposure to Radio Frequency Electromagnetic Fields, 3 kHz to 300 GHz.



- Council recommendation of 12 July 1999 on the limitation of exposure of the general public to electromagnetic fields (0 Hz to 300 GHz) (1999/519/EC) and respective national regulations.
- *Directive 2004/40/EC of the European Parliament and of the Council of 29 April 2004 on the minimum health and safety requirements regarding the exposure of workers to the risks arising from physical agents (electromagnetic fields) (18th individual Directive within the meaning of Article 16(1) of Directive 89/391/EEC).*
- US FCC limits for the general population. See the FCC web site at <http://www.fcc.gov>, and the policies, guidelines, and requirements in Part 1 of Title 47 of the Code of Federal Regulations, as well as the guidelines and suggestions for evaluating compliance in FCC OET Bulletin 65.
- Health Canada limits for the general population. See the Health Canada web site at [http://www.hc-sc.gc.ca/ewh-semt/pubs/radiation/99ehd-dhm237/limits-limités\\_e.html](http://www.hc-sc.gc.ca/ewh-semt/pubs/radiation/99ehd-dhm237/limits-limités_e.html) and Safety Code 6.
- EN 50383:2002 to 2010 Basic standard for the calculation and measurement of electromagnetic field strength and SAR related to human exposure from radio base stations and fixed terminal stations for wireless telecommunication systems (110 MHz - 40 GHz).
- BS EN 50385:2002 Product standard to demonstrate the compliances of radio base stations and fixed terminal stations for wireless telecommunication systems with the basic restrictions or the reference levels related to human exposure to radio frequency electromagnetic fields (110 MHz – 40 GHz) – general public.
- ICNIRP (International Commission on Non-Ionizing Radiation Protection) guidelines for the general public. See the ICNIRP web site at <http://www.icnirp.de/> and Guidelines for Limiting Exposure to Time-Varying Electric, Magnetic, and Electromagnetic Fields.

## Power density exposure limit

Install the radios for the PTP 550 family of PTP wireless solutions so as to provide and maintain the minimum separation distances from all persons.

The applicable power density exposure limit for RF energy between 4900 MHz and 6050 MHz is **10 W/m<sup>2</sup>**.

## Calculation of power density

The following calculation is based on the ANSI IEEE C95.1-1991 method, as that provides a worst case analysis. Details of the assessment to EN50383:2002 can be provided, if required.

Peak power density in the far field of a radio frequency point source is calculated as follows:

$$S = \frac{P \cdot G}{4\pi d^2}$$

**Where:**

S

P

G

d

**Is:**

power density in W/m<sup>2</sup>

maximum average transmit power capability of the radio, in W

total Tx gain as a factor, converted from dB

distance from point source, in m

Rearranging terms to solve for distance yields:

$$d = \sqrt{\frac{P \cdot G}{4\pi \cdot S}}$$

## Calculated distances

**Table 42** shows calculated minimum separation distances, recommended distances and resulting margins for each frequency band and antenna combination. These are conservative distances that include compliance margins. At these and greater separation distances, the power density from the RF field is below generally accepted limits for the general population.

## Calcul des distances pour la conformité aux limites de radiation radiofréquence

La **Table 43** indique les distances minimales de séparation calculées, les distances recommandées et les marges de sécurité qui en découlent pour chaque bande de fréquence et chaque antenne. Ces distances comprennent les marges de sécurité recommandées par les régulateurs. À ces distance et des distance supérieures, la densité de puissance du champ de radiofréquence est inférieur aux limites généralement admises pour la population.

**Table 30** Minimum safe distances - FCC

Band	Channel Size	Antenna	P (W) (*1)	G (*2)	S (W/m <sup>2</sup> ) (*3)	D (m) (*4)
5.1 GHz	20 MHz	On-board (2.0 dBi)	0.519	2	10	0.08
		Flat Panel (22.0 dBi)	0.102	158	10	0.36
	80 MHz	On-board (2.0 dBi)	0.079	2	10	0.03
		Flat Panel (22.0 dBi)	0.005	158	10	0.08
5.8 GHz	20 MHz	On-board (2.0 dBi)	0.495	2	10	0.08
		Flat Panel (22.0 dBi)	0.020	158	10	0.16
	80 MHz	On-board (2.0 dBi)	0.153	2	10	0.04
		Flat Panel (22.0 dBi)	0.008	158	10	0.10

(\*1) P: maximum average transmit power capability of the radio including cable loss (Watt)

*capacité de puissance d'émission moyenne maximale de la radio comprenant la perte dans les câble de connexion (W)*

(\*2) G: total transmit gain as a factor, converted from dB

*gain total d'émission, converti à partir de la valeur en dB*

(\*3) S: power density (W/m<sup>2</sup>)

*densité de puissance (W/m<sup>2</sup>)*

(\*4) d: minimum distance from point source (meters)

*distance minimale de source ponctuelle (en mètres)*

**Table 31** Minimum safe distances - ISEDC

Band	Channel Size	Antenna	P (W) (*1)	G (*2)	S (W/m <sup>2</sup> ) (*3)	D (m) (*4)	S @ 20 cm (W/m <sup>2</sup> ) (*5)
5.8 GHz	20 MHz	On-board (2.0 dBi)	0.495	2	9.69	0.08	1.56
		Flat Panel (22.0 dBi)	0.020	158	9.69	0.16	0.48
	80 MHz	On-board (2.0 dBi)	0.153	2	9.69	0.04	6.29
		Flat Panel (22.0 dBi)	0.008	158	9.69	0.10	2.60

(\*1) P: maximum average transmit power capability of the radio including cable loss (Watt)

*capacité de puissance d'émission moyenne maximale de la radio comprenant la perte dans les câble de connexion (W)*

(\*2) G: total transmit gain as a factor, converted from dB

*gain total d'émission, converti à partir de la valeur en dB*

(\*3) S: power density (W/m<sup>2</sup>)

*densité de puissance (W/m<sup>2</sup>)*

(\*4) d: minimum distance from point source (meters)

*distance minimale de source ponctuelle (en mètres)*

(\*5) S @ 20 cm: power density (W/m<sup>2</sup>) at 20 cm

*densité de puissance (W/m<sup>2</sup>), 20 cm*

**Note**

Gain of antenna in dBi =  $10 \cdot \log(G)$ .

The regulations require that the power used for the calculations is the maximum power in the transmit burst subject to allowance for source-based time-averaging.

At 5.4 GHz and EU 5.8 GHz, the products are generally limited to a fixed EIRP which can be achieved with the Integrated Antenna. The calculations above assume that the maximum EIRP allowed by the regulations is being transmitted.

**Note**

If there are no EIRP limits in the country of deployment, use the distance calculations in [Table 32 Minimum safe distances – full power](#) on page 4-67.

**Remarque**

Gain de l'antenne en dBi =  $10 \cdot \log(G)$ .

Les règlements exigent que la puissance utilisée pour les calculs soit la puissance maximale de la rafale de transmission soumis à une réduction pour prendre en compte le rapport cyclique pour les signaux modulés dans le temps.

Pour une opération dans la CEE dans les bandes 5,4 GHz et 5,8 GHz, les produits sont généralement limités à une PIRE qui peut être atteinte avec l'antenne intégrée. Les calculs ci-dessus supposent que la PIRE maximale autorisée par la réglementation est atteinte.

**Remarque**

Si aucune limite de PIRE existe pour le pays de déploiement, utilisez les calculs de distance pour FCC 5,8 GHz pour toutes les bandes de fréquence.

Pour la band FCC 5,8 GHz et les antennes entre 0,6 m (2 pieds) et 1,8 m (6 pieds), modifier la distance proportionnellement au gain de l'antenne.

**Table 32** Minimum safe distances – full power

Band	Channel Size	Antenna	P (W) (*1)	G (*2)	S (W/m <sup>2</sup> ) (*3)	D (m) (*4)
5.1/5.8 GHz	20 MHz	Flat Panel (22.0 dBi)	0.501	158	10	0.81
	80 MHz	Flat Panel (22.0 dBi)	0.501	158	10	0.81

## Compliance with radio regulations

---

This section describes how the PTP 550 complies with the radio regulations that are in force in various countries.

**Caution**

Where necessary, the end user is responsible for obtaining any National licenses required to operate this product and these must be obtained before using the product in any particular country. Contact the appropriate national administrations for details of the conditions of use for the bands in question and any exceptions that might apply.

**Caution**

Changes or modifications not expressly approved by Cambium Networks could void the user's authority to operate the system.

**Caution**

For the connectorized version of the product and in order to reduce potential radio interference to other users, the antenna type and its gain should be so chosen that the Effective Isotropically Radiated Power (EIRP) is not more than that permitted for successful communication.

**Attention**

Le cas échéant, l'utilisateur final est responsable de l'obtention des licences nationales nécessaires pour faire fonctionner ce produit. Celles-ci doivent être obtenus avant d'utiliser le produit dans un pays particulier. Contactez les administrations nationales concernées pour les détails des conditions d'utilisation des bandes en question, et toutes les exceptions qui pourraient s'appliquer

**Attention**

Les changements ou modifications non expressément approuvés par les réseaux de Cambium pourraient annuler l'autorité de l'utilisateur à faire fonctionner le système.

**Attention**

Pour la version du produit avec une antenne externe, et afin de réduire le risque d'interférence avec d'autres utilisateurs, le type d'antenne et son gain doivent être choisis afin que la puissance isotrope rayonnée équivalente (PIRE) ne soit pas supérieure au minimum nécessaire pour établir une liaison de la qualité requise.

---

## Type approvals

The system has been tested against various local technical regulations and found to comply. [Table 44](#) to [Table 47](#) list the radio specification type approvals that have been granted for PTP 550 products.

Some of the frequency bands in which the system operates are “license exempt” and the system is allowed to be used provided it does not cause interference. In these bands, the licensing authority does not guarantee protection against interference from other products and installations.

**Table 33** Radio certifications (5.1 GHz)

Region	Regulatory approvals
USA	FCC 47 CFR Part 15 E

**Table 34** Radio certifications (5.8 GHz)

Region	Regulatory approvals
USA	FCC 47 CFR Part 15 C
Canada	IC RSS-210 Issue 8, Annex 8 (or latest)
Eire	ComReg 02/71R4
Iceland	ETSI EN302 502 v1.2.1
Liechtenstein	ETSI EN302 502 v1.2.1
Norway	REG 2009-06-02 no. 580
Serbia	ETSI EN302 502 v1.2.1
Switzerland	ETSI EN302 502 v1.2.1

## FCC/IC compliance

The PTP 550 complies with the regulations that are in force in the USA and Canada.



### Caution

If a PTP 550 unit is interfering with radio or television reception (this can be determined by turning the equipment off and on), attempt the following corrective actions:

- Realign or relocate the antenna.
- Increase the separation between the affected equipment and antenna.
- Connect the ODU and PSU power supply into a power outlet on a circuit different from that to which the receiver is connected.
- Contact Cambium Point-to-Point for assistance.

## 5.1 GHz FCC notification

This device complies with part 15E of the US FCC Rules and Regulations. Operation is subject to the following two conditions: (1) This device may not cause harmful interference, and (2) This device must accept any interference received, including interference that may cause undesired operation.

For the connectorized version of the product and in order to reduce potential radio interference to other users, the antenna type and its gain should be so chosen that the equivalent isotropically radiated power (EIRP) is not more than that permitted by the regulations. The transmitted power must be reduced to achieve this requirement.

## 5.8 GHz FCC notification

This device complies with part 15C of the US FCC Rules. Operation is subject to the following two conditions: (1) This device may not cause harmful interference, and (2) This device must accept any interference received, including interference that may cause undesired operation.

## 5.8 GHz IC notification

RSS-GEN issue 3 (7.1.3) Licence-Exempt Radio Apparatus:

This device complies with Industry Canada license-exempt RSS standard(s). Operation is subject to the following two conditions: (1) this device may not cause interference, and (2) this device must accept any interference, including interference that may cause undesired operation of the device.

*Le présent appareil est conforme aux CNR d'Industrie Canada applicables aux appareils radio exempts de licence. L'exploitation est autorisée aux deux conditions suivantes : (1) l'appareil ne doit pas produire de brouillage, et (2) l'utilisateur de l'appareil doit accepter tout brouillage radioélectrique subi, même si le brouillage est susceptible d'en compromettre le fonctionnement.*

In Canada, high power radars are allocated as primary users (meaning they have priority) of the 5650 – 5850 MHz spectrum. These radars could cause interference or damage to license-exempt local area network (LE-LAN) devices.

Au Canada, les radars à haute puissance sont désignés comme utilisateurs principaux (ils ont la priorité) de la 5650 - spectre 5850 MHz. Ces radars peuvent causer des interférences et / ou interférer avec un réseau local ne nécessitant pas de licence.

## Selection of antennas

For guidance on the selection of dedicated external antennas refer to [Choosing external antennas](#) on page 3-31.



### Note

Under Industry Canada regulations, this radio transmitter may only operate using an antenna of a type and maximum (or lesser) gain approved for the transmitter by Industry Canada. To reduce potential radio interference to other users, the antenna type and its gain should be so chosen that the equivalent isotropically radiated power (EIRP) is not more than that necessary for successful communication.



### Remarque

Conformément à la réglementation d'Industrie Canada, le présent émetteur radio peut fonctionner avec une antenne d'un type et d'un gain maximal (ou inférieur) approuvé pour l'émetteur par Industrie Canada. Dans le but de réduire les risques de brouillage radioélectrique à l'intention des autres utilisateurs, il faut choisir le type d'antenne et son gain de sorte que la puissance isotrope rayonnée équivalente (p.i.r.e.) ne dépasse pas l'intensité nécessaire à l'établissement d'une communication satisfaisante.

---

## European Union compliance

The PTP 550 complies with the regulations that are in force in the European Union.



**Warning**

This is a Class A product. In a domestic environment this product may cause radio interference, in which case the user may be required to take adequate measures.

If a PTP 550 unit is interfering with radio or television reception (this can be determined by turning the equipment off and on), attempt the following corrective actions:

- Realign or relocate the antenna.
- Increase the separation between the affected equipment and antenna.
- Connect the ODU and PSU power supply into a power outlet on a circuit different from that to which the receiver is connected.

Contact Cambium Point-to-Point for assistance.

---

## 5.4 GHz European Union notification

The PTP 550 product is a two-way radio transceiver suitable for use in Broadband Wireless Access System (WAS), Radio Local Area Network (RLAN), or Fixed Wireless Access (FWA) systems. It is a Class 1 device and uses operating frequencies that are harmonized throughout the EU member states. The operator is responsible for obtaining any national licenses required to operate this product and these must be obtained before using the product in any particular country.

Hereby, Cambium Networks declares that the PTP 550 product complies with the essential requirements and other relevant provisions of Directive 1999/5/EC. The declaration of conformity may be consulted at the support website (see [Contacting Cambium Networks](#) on page 1).

## 5.8 GHz European Union notification

The PTP 550 is a Class 2 device as it operates on frequencies that are not harmonized across the EU. Currently the product may only be operated in the countries listed in [Table 47](#). However, the regulatory situation in Europe is changing and the radio spectrum may become available in other countries in future. See [www.ero.dk](http://www.ero.dk) for further information. The operator is responsible for obtaining any national licenses required to operate this product and these must be obtained before using the product in any particular country.

**Caution**

This equipment operates as a secondary application, so it has no rights against harmful interference, even if generated by similar equipment, and must not cause harmful interference on systems operating as primary applications.

---

Hereby, Cambium Networks declares that the PTP 550 product complies with the essential requirements and other relevant provisions of Directive 1999/5/EC. The declaration of conformity may be consulted at the support website (see [Contacting Cambium Networks](#) on page 1).

## 5.8 GHz operation in the UK

The PTP 550 Connectorized product has been notified for operation in the UK, and when operated in accordance with instructions for use it is compliant with UK Interface Requirement IR2007. For UK use, installations must conform to the requirements of IR2007 in terms of EIRP spectral density against elevation profile above the local horizon in order to protect Fixed Satellite Services.



---

## Chapter 5: Installation

---

This chapter describes how to install and test the hardware for a PTP 550 link. It contains the following topics:

- [Safety](#) on page 5-2 contains important safety guidelines that must be observed by personnel installing or operating PTP 550 equipment.
- [Installing the ODU](#) on page 5-5 describes how to mount and ground an integrated or connectorized ODU.
- [Install external antennas for a connectorized ODU](#) on page 5-8 describes how to mount and connect an external antenna for the connectorized ODU.
- [Installing the copper Cat5e Ethernet interface](#) on page 5-9 describes how to install the copper Cat5e power over Ethernet interface from the ODU (PSU port) to the PSU.
- [Installing the PSU](#) on page 5-13 describes how to install a power supply unit for the PTP 550.
- [Installing an SFP Ethernet interface](#) on page 5-14 describes how to install an optical or copper Cat5e Ethernet interface from the ODU (SFP port) to a connected device.
- [Supplemental installation information](#) on page 5-23 contains detailed installation procedures that are not included in the above topics, such as how to strip cables, create grounding points and weatherproof connectors.

# Safety

---

**Warning**

To prevent loss of life or physical injury, observe the following safety guidelines. In no event shall Cambium Networks be liable for any injury or damage caused during the installation of the Cambium PTP 550. Ensure that only qualified personnel install a PTP 550 link.

---

## Power lines

Exercise extreme care when working near power lines.

## Working at heights

Exercise extreme care when working at heights.

## PSU

Always use one of the Cambium PTP 550 Series power supply units (PSU) to power the ODU. Failure to use a Cambium supplied PSU could result in equipment damage and will invalidate the safety certification and may cause a safety hazard.

## Grounding and protective earth

The Outdoor Unit (ODU) must be properly grounded to protect against lightning. It is the user's responsibility to install the equipment in accordance with national regulations. In the USA follow the requirements of the National Electrical code NFPA 70-2005 and 780-2004 *Installation of Lightning Protection Systems*. In Canada, follow Section 54 of the *Canadian Electrical Code*. These codes describe correct installation procedures for grounding the outdoor unit, mast, lead-in wire and discharge unit, size of grounding conductors and connection requirements for grounding electrodes. Other regulations may apply in different countries and therefore it is recommended that installation of the outdoor unit be contracted to a professional installer.

## Powering down before servicing

Before servicing PTP 550 equipment, always switch off the power supply and unplug it from the PSU.

Do not disconnect the RJ45 drop cable connectors from the ODU while the PSU is connected to the power supply. Always remove the AC or DC input power from the PSU.

## Primary disconnect device

The main power supply is the primary disconnect device.

## External cables

Safety may be compromised if outdoor rated cables are not used for connections that will be exposed to the outdoor environment. For outdoor copper Cat5e Ethernet interfaces, always use Cat5e cable that is gel-filled and shielded with copper-plated steel. Alternative types of drop cable are not supported by Cambium Networks.

## Drop cable tester

The PSU output voltage may be hazardous in some conditions, for example in wet weather. Do NOT connect the drop cable tester to the PSU.

## RF exposure near the antenna

Strong radio frequency (RF) fields will be present close to the antenna when the transmitter is on. Always turn off the power to the ODU before undertaking maintenance activities in front of the antenna.

## Minimum separation distances

Ensure that personnel are not exposed to unsafe levels of RF energy. The units start to radiate RF energy as soon as they are powered up. Never work in front of the antenna when the ODU is powered. Install the ODUs so as to provide and maintain the minimum separation distances from all persons. For minimum separation distances, see [Calculated distances](#) on page 4-65.

## Grounding and lightning protection requirements

Ensure that the installation meets the requirements defined in [Grounding and lightning protection](#) on page 3-22.

## Grounding cable installation methods

To provide effective protection against lightning induced surges, observe these requirements:

- Grounding conductor runs are as short, straight and smooth as possible, with bends and curves kept to a minimum.
- Grounding cables must not be installed with drip loops.
- All bends must have a minimum radius of 200 mm (8 in) and a minimum angle of 90°. A diagonal run is preferable to a bend, even though it does not follow the contour or run parallel to the supporting structure.
- All bends, curves and connections must be routed towards the grounding electrode system, ground rod, or ground bar.
- Grounding conductors must be securely fastened.
- Braided grounding conductors must not be used.

- Approved bonding techniques must be used for the connection of dissimilar metals.

## Siting ODUs and antennas

ODUs and external antennas are not designed to survive direct lightning strikes. For this reason they must be installed in Zone B as defined in [Lightning protection zones](#) on page 3-22. Mounting in Zone A may put equipment, structures and life at risk.

## Thermal Safety

The ODU enclosure may be hot to the touch when in operation. The ODU must not be operated in ambient temperatures exceeding 40°C unless mounted in a Restricted Access Location.



### Warning

Do not install the ODU in a location where the ambient temperature could exceed 40°C unless this is a Restricted Access Location as defined by EN 60950-1.



### Alerte

L'unité externe ne doit pas être installée dans un endroit où la température ambiante est supérieure à 40C à moins que l'accès soit limité au personnel autorisé.

---

## Installing the ODU

---

To install the ODU, use the following procedures:

- [Attach ground cables to the ODU](#) on page 5-5
- [Mount the ODU on the mast](#) on page 5-5

### Attach ground cables to the ODU

- 1 Fasten one ground cable to each ODU grounding point using the M6 (small) lugs: one is for the surge suppressor and the other is for the tower or building (M10 lug at other end). It does not matter which cable goes on which ODU grounding point.
- 2 Tighten both ODU grounding bolts to a torque of 5 Nm (3.9 lb ft).

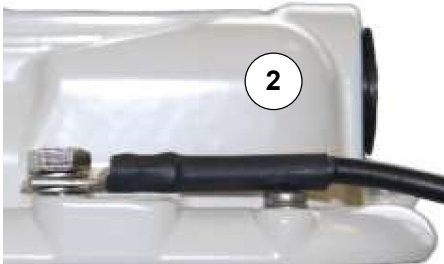

### Mount the ODU on the mast

Refer to individual procedures below for mounting the PTP 550 ODU:

- [Low profile bracket on small diameter pole](#) on page 5-6
- [Low profile bracket on large pole](#) on page 5-7

## Low profile bracket on small diameter pole

- 1 Fix the low profile bracket to the back of the ODU using the M6 bolts and washers provided. Tighten the four bolts to a torque setting of 5.0 Nm (3.7 lb ft).
- 2 Pass the M8 coach bolts through the square holes in the hinged portion of the bracket. Close the bracket. Two M6 bolts should pass through slots in the fixed portion of the bracket. Ensure that the spring and plain washers of the M6 bolts are on the outside of the bracket assembly. Tighten the four M6 bolts to ensure that the bracket cannot open accidentally.
- 3 Hoist the ODU to the mounting position.
- 4 Attach the bracket to the pole using the bracket clamp, washers and M8 nuts.
- 5 Adjust the azimuth to achieve visual alignment. Tighten the two M8 bracket nuts to a torque setting of 8.0 Nm (6.0 lb ft). Do not over-tighten these nuts as this may lead to failure of the assembly.
- 6 Adjust the elevation to achieve visual alignment. Tighten the four M6 bolts to a torque setting of 5.0 Nm (3.7 lb ft).

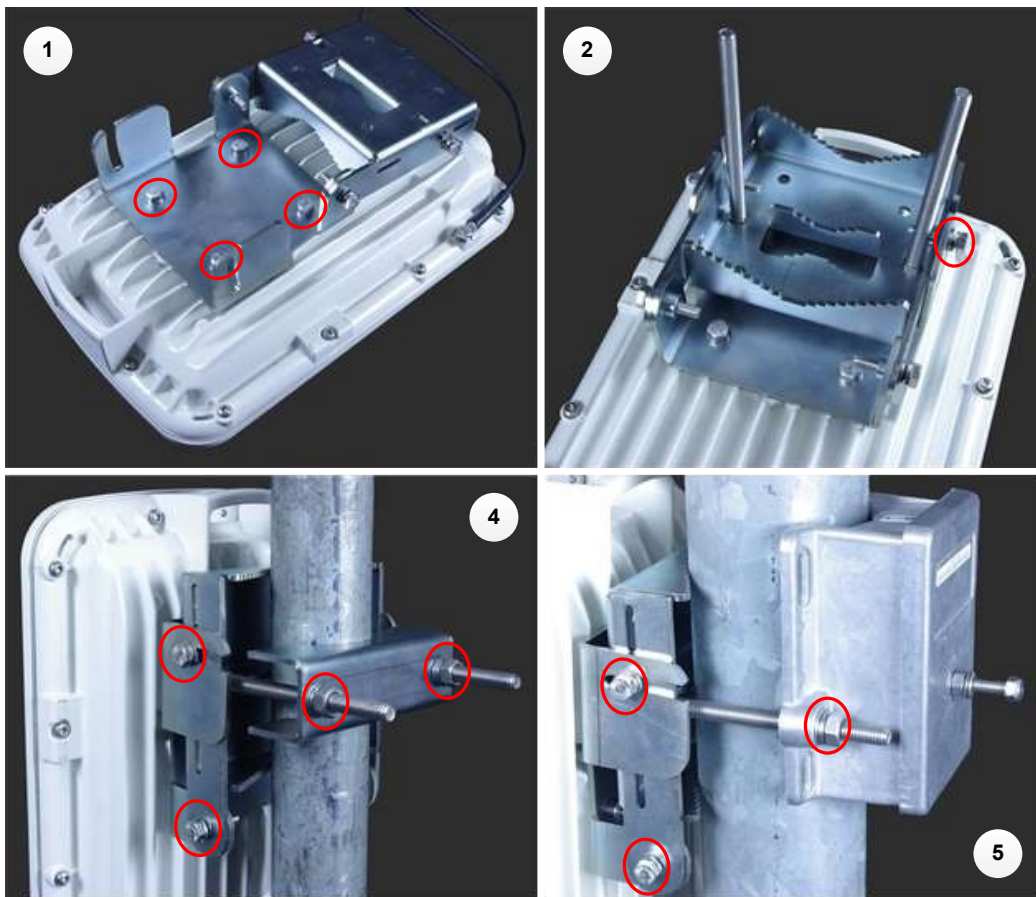



## Low profile bracket on large pole

- 1 Fix the low profile bracket to the back of the ODU using the M6 bolts and washers provided. Tighten the four bolts to a torque setting of 5.0 Nm (3.7 lb ft). This step is common with the low profile bracket on a smaller diameter pole.
- 2 Close the bracket. Two M6 bolts should pass through slots in the fixed portion of the bracket. Ensure that the spring and plain washers of the M6 bolts are on the outside of the bracket assembly. Tighten the four M6 bolts to ensure that the bracket cannot open accidentally. Feed the Jubilee straps through the slots in the adaptor plate. This is similar to the procedure for the large diameter extension kit.
- 3 Hoist the ODU to the mounting position.
- 4 Attach the bracket to the pole using the Jubilee straps.
- 5 Adjust the azimuth to achieve visual alignment. Tighten the Jubilee straps to a torque setting of 6.0 Nm (4.5 lb ft).
- 6 Adjust the elevation to achieve visual alignment. Tighten the four M6 bolts to a torque setting of 5.0 Nm (3.7 lb ft).



## Install external antennas for a connectorized ODU

To mount and connect an external antenna for the connectorized ODU, proceed as follows:

- 1 Mount the antenna(s) according to manufacturer's instructions. When using separate antennas to achieve spatial diversity, mount one with Horizontal polarization and the other with Vertical polarization.
- 2 Connect the ODU V and H interfaces to the antenna(s) with RF cable of type LMR-400 (Cambium part numbers 30010194001 and 30010195001) and N type connectors (Cambium part number 09010091001). Tighten the N type connectors to a torque setting of 1.7 Nm (1.3 lb ft).
- 3 If the ODU is mounted indoors, install lightning arrestors at the building entry point:
- 4 Form drip loops near the lower ends of the antenna cables. These ensure that water is not channeled towards the connectors.
- 5 If the ODU is mounted outdoors, weatherproof the N type connectors (when antenna alignment is complete) using PVC tape and self-amalgamating rubber tape.
- 6 Weatherproof the antenna connectors in the same way (unless the antenna manufacturer specifies a different method).

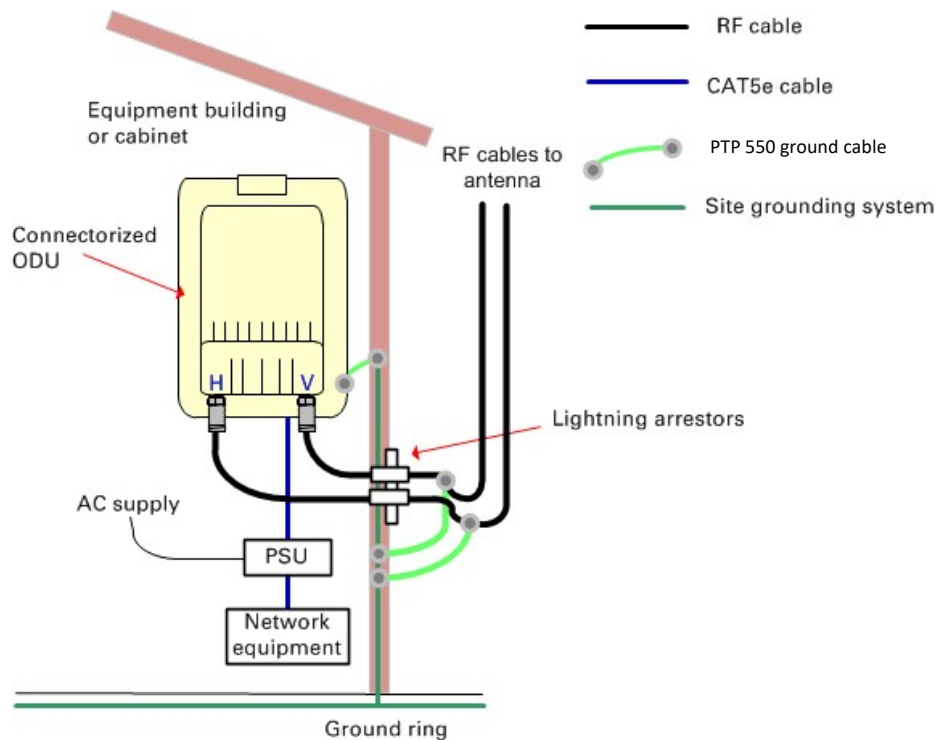

- 7 Ground the antenna cables to the supporting structure within 0.3 meters (1 foot) of the ODU and antennas using the Cambium grounding kit (part number 01010419001):
- 8 Fix the antenna cables to the supporting structure using site approved methods. Ensure that no undue strain is placed on the ODU or antenna connectors. Ensure that the cables do not flap in the wind, as flapping cables are prone to damage and induce unwanted vibrations in the supporting structure.

# Installing the copper Cat5e Ethernet interface

---

To install the copper Cat5e Ethernet interface, use the following procedures:

- [Install the main drop cable](#) on page 5-9
- [Test resistance in the drop cable](#) on page 5-11

**Caution**

To avoid damage to the installation, do not connect or disconnect the drop cable when power is applied to the PSU or network terminating equipment.

**Caution**

Do not connect the SFP drop cables to the PSU, as this may damage equipment.

**Caution**

Always use Cat5e cable that is gel-filled and shielded with copper-plated steel. Alternative types of Cat5e cable are not supported by Cambium Networks. Cambium Networks supply this cable (Cambium part numbers WB3175 and WB3176), RJ45 connectors (Cambium part number WB3177) and a crimp tool (Cambium part number WB3211).

---

## Install the main drop cable

---

**Warning**

The metal screen of the drop cable is very sharp and may cause personal injury.

- ALWAYS wear cut-resistant gloves (check the label to ensure they are cut resistant).
- ALWAYS wear protective eyewear.
- ALWAYS use a rotary blade tool to strip the cable (DO NOT use a bladed knife).

**Warning**

Failure to obey the following precautions may result in injury or death:

- Use the proper hoisting grip for the cable being installed. If the wrong hoisting grip is used, slippage or insufficient gripping strength will result.
  - Do not reuse hoisting grips. Used grips may have lost elasticity, stretched, or become weakened. Reusing a grip can cause the cable to slip, break, or fall.
  - The minimum requirement is one hoisting grip for each 60 m (200 ft) of cable.
- 

## Cut to length and fit hoisting grips

- 1 Cut the main drop cable to length.
- 2 Slide one or more hoisting grips onto the top end of the drop cable.
- 3 Secure the hoisting grip to the cable using a special tool, as recommended by the manufacturer.

## Terminate with RJ45 connectors and glands



### Caution

Check that the crimp tool matches the RJ45 connector, otherwise the cable or connector may be damaged.

- 1 Thread the cable gland (with black cap) onto the main drop cable.
- 2 Strip the cable outer sheath and fit the RJ45 connector load bar.
- 3 Fit the RJ45 connector housing as shown. To ensure there is effective strain relief, locate the cable inner sheath under the connector housing tang. Do not tighten the gland nut:



Pin	Color (Supplied cable)	Color (Conventional)	Pins on plug face
1	Light Orange	White/Orange	
2	Orange	Orange	
3	Light Green	White/Green	
4	Blue	Blue	
5	Light Blue	White/Blue	
6	Green	Green	
7	Light Brown	White/Brown	
8	Brown	Brown	

## Hoist and fix the main drop cable



### Warning

Failure to obey the following precautions may result in injury or death:

- Use the hoisting grip to hoist one cable only. Attempting to hoist more than one cable may cause the hoisting grip to break or the cables to fall.
- Do not use the hoisting grip for lowering cable unless the clamp is securely in place.
- Maintain tension on the hoisting grip during hoisting. Loss of tension can cause dangerous movement of the cable and result in injury or death to personnel.
- Do not release tension on the grip until after the grip handle has been fastened to the supporting structure.
- Do not apply any strain to the RJ45 connectors.



### Caution

Do not lay the drop cable alongside a lightning air terminal.

- 1 Hoist the top end of the main drop cable up to the ODU, following the hoist manufacturer's instructions. When the cable is in position, fasten the grip handle to the supporting structure and remove the hoist line.
- 2 Connect the main drop cable to the ODU.
- 3 Attach the main drop cable to the supporting structure using site approved methods.

## Ground the main drop cable

At all required grounding points, connect the screen of the main drop cable to the metal of the supporting structure using the cable grounding kit (Cambium part number 01010419001).

## Test resistance in the drop cable

Test that the resistances between pins are within the correct limits, as specified in the table below. If any of the tests fail, examine the drop cable for wiring faults.

Connection to a terminated cable can be achieved reliably by use of a suitable cable adaptor. One example is the Modapt adaptor manufactured by The Siemon Company.

Cable length		Maximum Resistance (Ohm) between RJ45 pins		
Ft	m	1 & 2, 3 & 6, 4 & 5, 7 & 8	1 & 3	4 & 7
0	0	0.8	1	1.6
33	10	2.5	2.7	3.3
66	20	4.2	4.4	5
88	30	5.9	6.1	6.7

131	40	7.6	7.8	8.4
164	50	9.3	9.5	10.1
197	60	11	11.2	11.8
230	70	12.7	12.9	13.5
262	80	14.4	14.6	15.2
295	90	16.1	16.3	16.9
328	100	17.8	18	18.6
656	200	34.8	35	35.6
984	300	51.8	52	52.6

#### Minimum Resistance (Ohm) between Adaptor pins

1 & Screen	8 & Screen	1 & 7
> 100 K	> 100 K	> 2 K



#### Note

A resistance of 20 Ohms is the maximum allowed when the cable is carrying Ethernet.  
 A resistance of 60 Ohms is the maximum allowed when the cable is carrying only power to the ODU (when Ethernet is carried by one of the other ODU interfaces).



#### Note

Ensure that these resistances are within 10% of each other by multiplying the lowest resistance by 1.1. If any of the other resistances are greater than this, the test has failed.

## Installing the PSU

---

Install one of the following types of PSU (as specified in the installation plan):

- PTP 550 AC Power Injector (Cambium part number N000000L034A). Refer to [Installing the AC Power Injector](#) on page 5-13.

**Warning**

Always use an appropriately rated and approved AC supply cord-set in accordance with the regulations of the country of use.

**Caution**

As the PSU is not waterproof, locate it away from sources of moisture, either in the equipment building or in a ventilated moisture-proof enclosure. Do not locate the PSU in a position where it may exceed its temperature rating.

**Caution**

Do not plug any device other than a PTP 550 ODU into the ODU port of the PSU. Other devices may be damaged due to the non-standard techniques employed to inject DC power into the Ethernet connection between the PSU and the ODU.

Do not plug any device other than a Cambium PTP 550 PSU into the PSU port of the ODU. Plugging any other device into the PSU port of the ODU may damage the ODU and device.

---

## Installing the AC Power Injector

Follow this procedure to install the AC Power Injector (Cambium part number N000000L034A):

- 1 Form a drip loop on the PSU end of the drop cable. The drip loop ensures that any moisture that runs down the cable cannot enter the PSU.
- 2 (a) Place the AC Power Injector on a horizontal surface. Plug the ODU to PSU drop cable into the PSU port labeled ODU. (b) When the system is ready for network connection, connect the network Cat5e cable to the LAN port of the PSU:

(a)



(b)



## Installing an SFP Ethernet interface

---

In more advanced configurations, there may be an optical or copper Cat5e Ethernet interface connected to the SFP port of the ODU.

Adapt the installation procedures in this chapter as appropriate for SFP interfaces, noting the following differences from a PSU interface:

- Install an optical or copper SFP module in the ODU (SFP port) and connect the SFP optical or copper cable into this module using the long cable gland from the SFP module kit. This is described in the following procedures:
  - [Fitting the long cable gland](#) on page 5-16
  - [Inserting the SFP module](#) on page 5-17
  - [Connecting the cable](#) on page 5-20
  - [Fitting the gland](#) on page 5-21
  - [Removing the cable and SFP module](#) on page 5-22
- Optical cables do not require ground cables.
- At the remote end of an SFP drop cable, use an appropriate termination for the connected device.
- If the connected device is outdoors, not in the equipment building or cabinet, adapt the grounding instructions as appropriate.



**Figure 18** ODU with copper Cat5e connections to both Ethernet ports

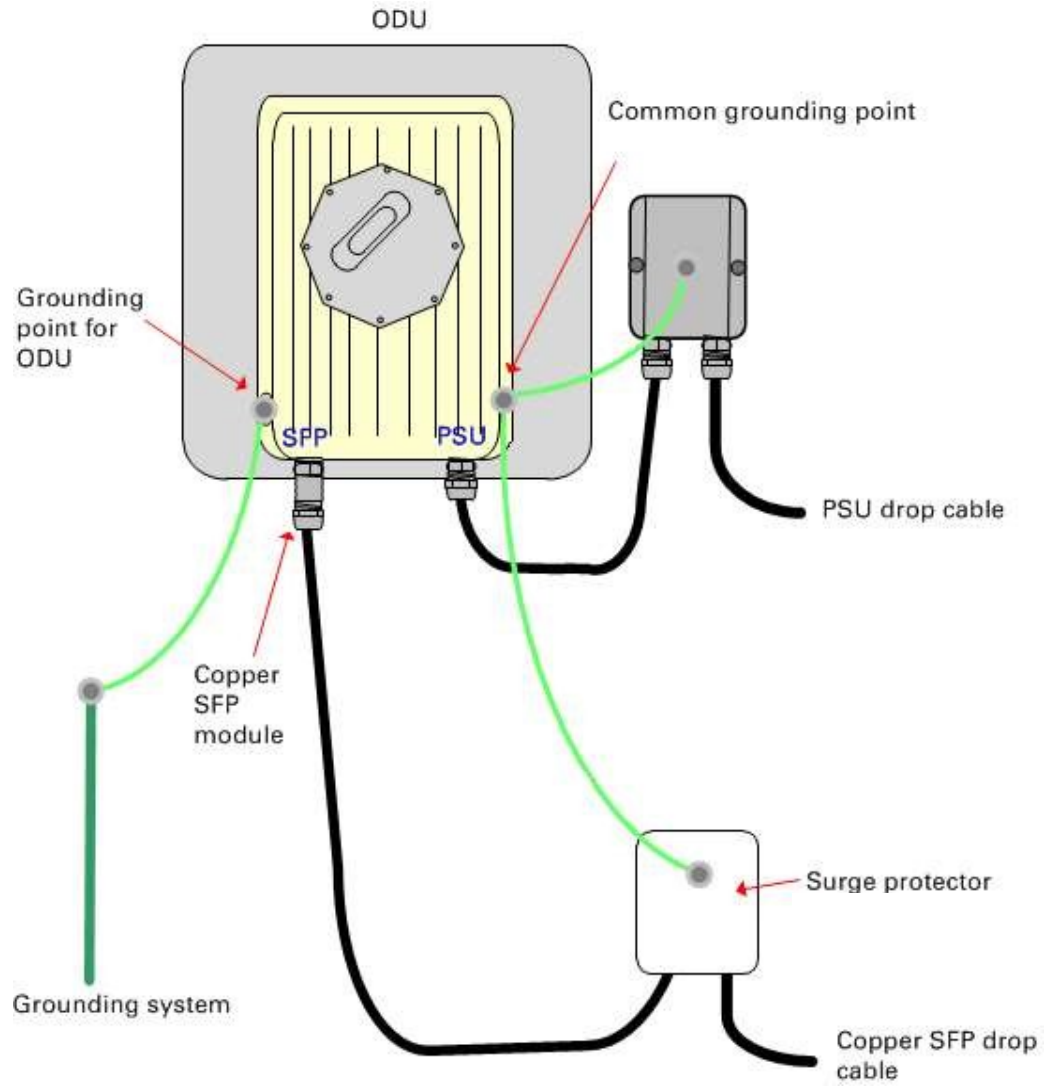

## Fitting the long cable gland

**Optical SFP interface:** Disassemble the long cable gland and thread its components over the LC connector at the ODU end as shown below.

**Copper Cat5e SFP interface:** Disassemble the long cable gland and thread its components over the RJ45 connector at the ODU end as shown below.

- 1 Disassemble the gland:



- 2 Thread each part onto the cable (the rubber bung is split):



- 3 Assemble the spring clip and the rubber bung (the clips go inside the ring):



- 4 Fit the parts into the body and lightly screw on the gland nut (do not tighten it):  
Optical



Copper



## Inserting the SFP module

To insert the SFP module into the ODU, proceed as follows:

- 1 Remove the blanking plug from the SFP port of the ODU:



- 2** Insert the SFP module into the SFP receptacle with the label up:

Optical



Copper



- 3** Push the module home until it clicks into place:

Optical



Copper



- 4 Rotate the latch to the locked position:

Optical



Copper

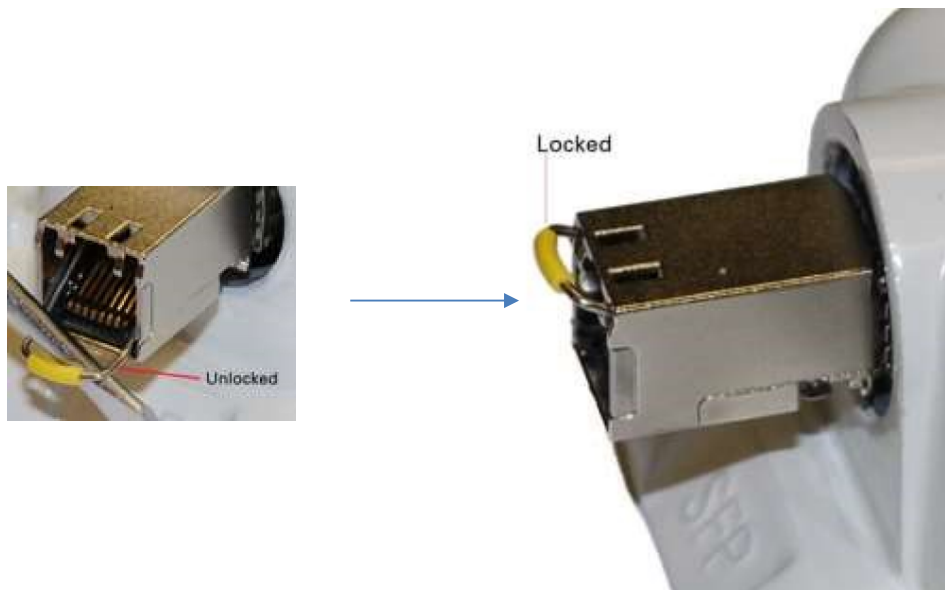

## Connecting the cable



### Caution

The fiber optic cable assembly is very delicate. To avoid damage, handle it with extreme care. Ensure that the fiber optic cable does not twist during assembly, especially when fitting and tightening the weatherproofing gland.

Do not insert the power over Ethernet drop cable from the PSU into the SFP module, as this will damage the module.

- 1 Remove the LC connector dust caps from the ODU end (optical cable only):



- 2 Plug the connector into the SFP module, ensuring that it snaps home:

Optical



Copper



## Fitting the gland

- 1 Fit the gland body to the SFP port and tighten it to a torque of 5.5 Nm (4.3 lb ft)



- 2 Fit the gland nut and tighten until the rubber seal closes on the cable. Do not over-tighten the gland nut, as there is a risk of damage to its internal components:



## Removing the cable and SFP module

Do not attempt to remove the module without disconnecting the cable, otherwise the locking mechanism in the ODU will be damaged.

- 1 Remove the cable connector by pressing its release tab before pulling it out:

Optical



Copper

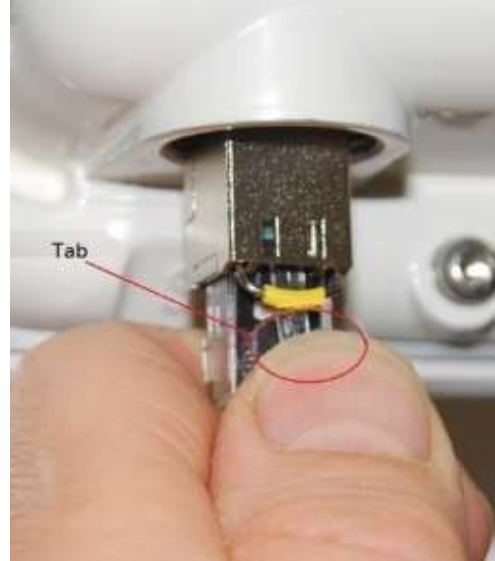

- 2 Rotate the latch to the unlocked position. Extract the module by using a screwdriver:

Optical

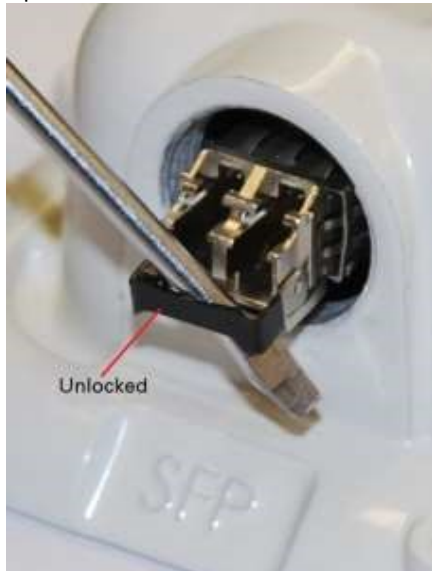

Copper





## Supplemental installation information

This section contains detailed installation procedures that are not included in the above topics, such as how to strip cables, create grounding points and weatherproof connectors.

### Stripping drop cable

When preparing drop cable for connection to the PTP 550 ODU, use the following measurements:

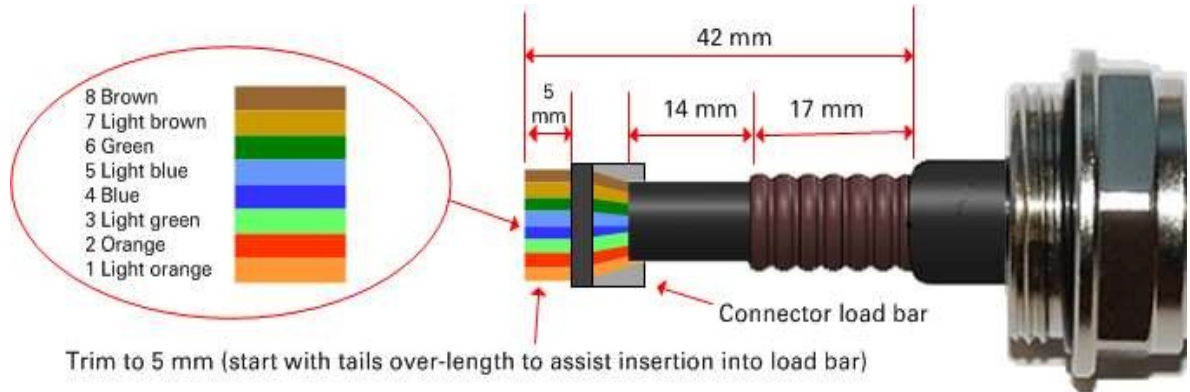

When preparing drop cable for connection to the PTP 550 PSU (without a cable gland), use the following measurements:

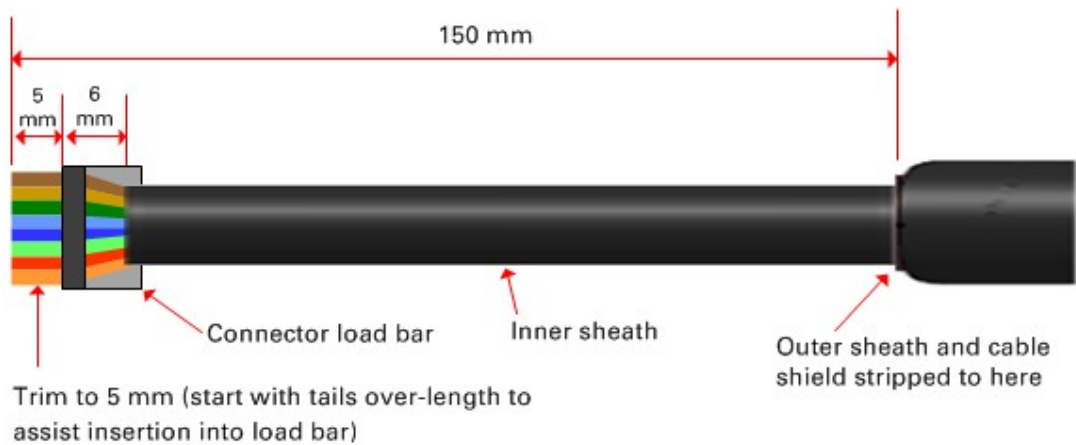

## Creating a drop cable grounding point

Use this procedure to connect the screen of the main drop cable to the metal of the supporting structure using the cable grounding kit (Cambium part number 01010419001).

To identify suitable grounding points, refer to [Drop cable grounding points](#) on page 3-25.

- 1 Remove 60 mm (2.5 inches) of the drop cable outer sheath.

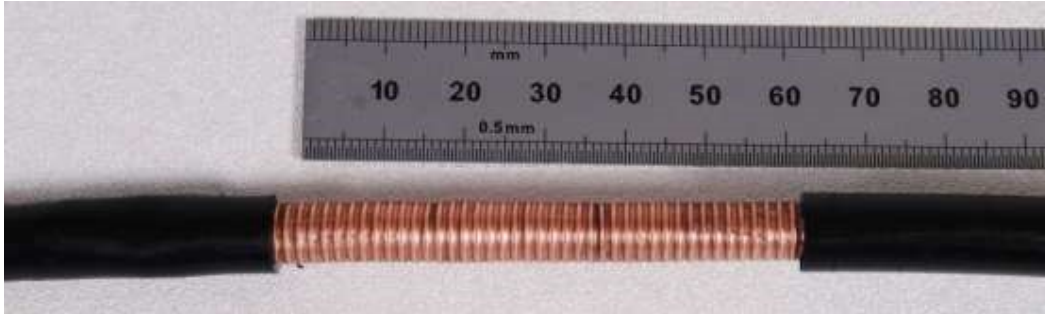

- 2 Cut 38mm (1.5 inches) of rubber tape (self-amalgamating) and fit to the ground cable lug. Wrap the tape completely around the lug and cable.



- 3 Fold the ground wire strap around the drop cable screen and fit cable ties.



- 4 Tighten the cable ties with pliers. Cut the surplus from the cable ties.



- 5 Cut a 38mm (1.5 inches) section of self-amalgamating tape and wrap it completely around the joint between the drop and ground cables.



- 6 Use the remainder of the self-amalgamating tape to wrap the complete assembly. Press the tape edges together so that there are no gaps.



- 7 Wrap a layer of PVC tape from bottom to top, starting from 25 mm (1 inch) below and finishing 25 mm (1 inch) above the edge of the self-amalgamating tape, over lapping at half width.



- 8 Repeat with a further four layers of PVC tape, always overlapping at half width. Wrap the layers in alternate directions (top to bottom, then bottom to top). The edges of each layer should be 25mm (1 inch) above (A) and 25 mm (1 inch) below (B) the previous layer.



- 9 Prepare the metal grounding point of the supporting structure to provide a good electrical contact with the grounding cable clamp. Remove paint, grease or dirt, if present. Apply anti-oxidant compound liberally between the two metals.
- 10 Clamp the bottom lug of the grounding cable to the supporting structure using site approved methods. Use a two-hole lug secured with fasteners in both holes. This provides better protection than a single-hole lug.

## Weatherproofing an N type connector

Use this procedure to weatherproof the N type connectors fitted to the connectorized ODU and external antenna (if recommended by the antenna manufacturer).

- 1 Ensure the connection is tight. A torque wrench should be used if available:



- 2 Wrap the connection with a layer of 19 mm (0.75 inch) PVC tape, starting 25 mm (1 inch) below the connector body. Overlap the tape to half-width and extend the wrapping to the body of the cable. Avoid making creases or wrinkles:



- 3 Smooth the tape edges:



- 4** Cut a 125mm (5 inches) length of rubber tape (self-amalgamating):



- 5** Expand the width of the tape by stretching it so that it will wrap completely around the connector and cable:



- 6** Press the tape edges together so that there are no gaps. The tape should extend 25 mm (1 inch) beyond the PVC tape:



- 7** Wrap a layer of 50 mm (2 inch) PVC tape from bottom to top, starting from 25 mm (1 inch) below the edge of the self-amalgamating tape, overlapping at half width.



- 8** Repeat with a further four layers of 19 mm (0.75 inch) PVC tape, always overlapping at half width. Wrap the layers in alternate directions:
- Second layer: top to bottom.
  - Third layer: bottom to top.
  - Fourth layer: top to bottom.
  - Fifth layer: bottom to top.

The bottom edge of each layer should be 25 mm (1 inch) below the previous layer.



- 9** Check the completed weatherproof connection:



---

# Chapter 6: Configuration and alignment

---

This chapter describes how to use the web interface to configure the PTP 550 link. It also describes how to align antennas. This chapter contains the following topics:

- [Preparing for configuration and alignment](#) on page 6-2
- [Connecting to the unit](#) on page 6-3
- [Using the web interface](#) on page 6-5
- [Other configuration tasks](#) on page 6-59



# Preparing for configuration and alignment

---

This section describes the checks to be performed before proceeding with unit configuration and antenna alignment.

## Safety precautions

All national and local safety standards must be followed while configuring the units and aligning the antennas.

---



### Warning

Ensure that personnel are not exposed to unsafe levels of RF energy. The units start to radiate RF energy as soon as they are powered up. Respect the safety standards defined in [Compliance with safety standards](#) on page 4-63, in particular the minimum separation distances.

Observe the following guidelines:

- Never work in front of the antenna when the ODU is powered.
  - Always power down the PSU before connecting or disconnecting the drop cable from the PSU or ODU.
- 

## Regulatory compliance

All applicable radio regulations must be followed while configuring the units and aligning the antennas. For more information, refer to [Compliance with radio regulations](#) on page 4-68.

---



### Caution

If the system designer has provided a list of channels to be barred for TDWR radar avoidance, the affected channels must be barred before the units are allowed to radiate on site, otherwise the regulations will be infringed.

---



### Attention

Si le concepteur du système a fourni une liste de canaux à interdire pour éviter les radars TDWR, les canaux concernées doivent être interdits avant que les unités sont autorisées à émettre sur le site, sinon la réglementation peut être enfreinte.

---

## Selecting configuration options

Use the installation report to determine which configuration options are required. Refer to [LINKPlanner](#) on page 3-29.

## Connecting to the unit

---

This section describes how to connect the unit to a management PC and power it up.

### Configuring the management PC

Use this procedure to configure the local management PC to communicate with the PTP 550.

**Procedure:**

- 1 Select **Properties** for the Ethernet port. In Windows 7 this is found in **Control Panel > Network and Internet > Network Connections > Local Area Connection**.
- 2 Select **Internet Protocol (TCP/IP)**:

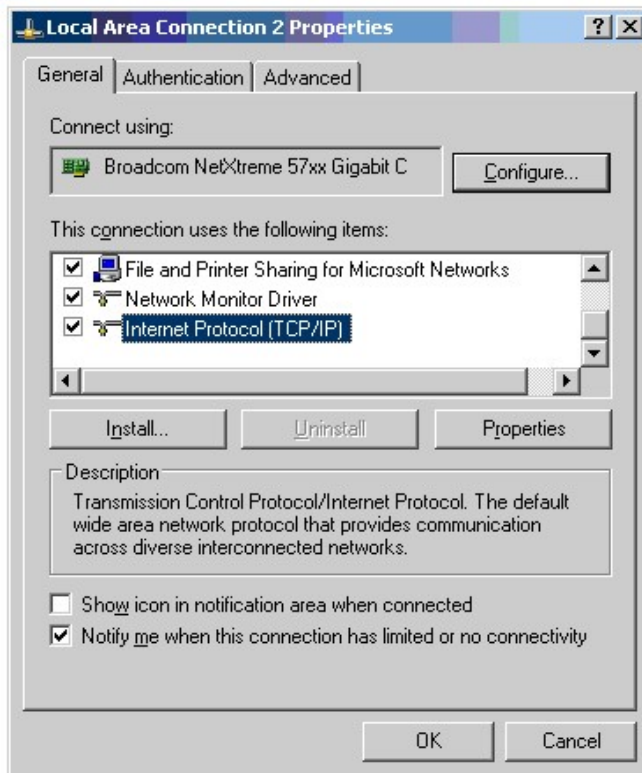

- 3 Click **Properties**.

- 4 Enter an IP address that is valid for the 169.254.X.X network, avoiding 169.254.0.0 and 169.254.1.1. A good example is 169.254.1.3:

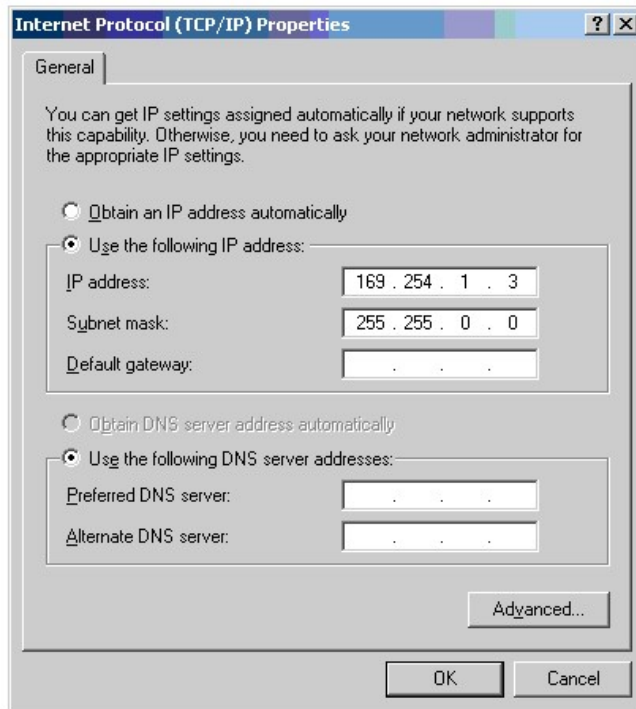

- 5 Enter a subnet mask of 255.255.0.0. Leave the default gateway blank.

## Connecting to the PC and powering up

Use this procedure to connect a management PC and power up the PTP 550.

### Procedure:

- 1 Check that the ODU ETH port is connected to the Ethernet + Power port of the power supply.
- 2 Connect the PC Ethernet port to the LAN port of the PSU using a standard (not crossed) Ethernet cable.
- 3 Apply mains or battery power to the PSU. The green Power LED should illuminate continuously.
- 4 Check that the ODU red Ethernet LED illuminates continuously. If the Power and Ethernet LEDs do not illuminate correctly, refer to [Testing hardware](#) on page 7-64.

## Using the web interface

This section describes how to log into the PTP 550 web interface and use its menus.

### Logging into the web interface

Use this procedure to log into the web interface as a system administrator.

#### Procedure:

- 1 Start the web browser from the management PC.
- 2 Type the IP address of the unit into the address bar. The factory default IP address is **169.254.1.1**. Press ENTER. The login prompt is displayed:



- 3 Enter Username: admin and Password: admin then click **Log In**. The **System Status** page is displayed:

**System Status**

**Ethernet / Network**

Main PTP Port	1001 Main / Full	
SFP Pp1t	Down	
SFP Port Type	N/A	
Ethernet MAC Address	00:04:56:28:00:4F	
SFP Port MAC Address	00:04:56:28:06:51	

**Wireless**

Wireless MAC Address	00:04:56:28:06:50	00:04:56:28:06:51
Wireless Status	Up	Up
Operating Frequency	5040 MHz	5800 MHz
Operating Channel Bandwidth	20 MHz	20 MHz
Registered Slave Module MAC Address	00:04:56:28:05:FA	00:04:56:28:05:FB
Transmit Power	18 dBm	18 dBm

**Equipment**

SSID	PTP550-Master-1
Device Name	PTP550-280078
Software Version	4.1-8835
Firmware Version	U-Boot IP0806v 2012.07.25 (Mar 07 2018 - 21:29:22)
Country FCC (US)	28-88FT0008
Unit IDN	181L009W1508
Country	Other
System Uptime	7 days, 1 hour, 36 minutes, 51 seconds

## Using the installation wizard (Master Mode)

The PTP 550 device features a guided configuration mechanism for configuring key parameters for link operation.

**Start Setup**

This setup is accessed on the **Installation** page by clicking the **Start Setup** button.

Click **Finish Setup** to commit the changes to the device.

### Installation wizard step 1 – Main system parameters

Installation

**Cancel Setup** **Finish Setup**

◀
Main
Radio
Network
Security
▶

Main

Device Name \*

Radio Mode \*  Master  Slave

Forward Compatibility (Beta Quality)  Disabled  Enabled

SSID

Attribute	Meaning
<b>Main</b>	
Device Name	The configured identifier used in an NMS such as cnMaestro
Radio Mode	<p><b>Master:</b> The unit controls the point-to-point link and its maintenance. On startup, the Master transmits until a link with the Slave is made.</p> <p><b>Slave:</b> The unit listens for its peer and only transmits when the peer has been identified.</p>
SSID	SSID is a unique identifier for a wireless LAN which is specified in the Master's beacon. (Master Mode). SSID must be same at both ends and different to site name.
WPA2 Pre-shared Key	Configure this key on the Master, then configure the Slave with this key to complete the authentication configuration. This key must be between 8 to 128 symbols.

## Installation wizard step 2 – Radio parameters

### Installation

Cancel Setup Finish Setup

◀ Main Radio Network Security ▶

**Radio**

**Country**

**Downlink/Uplink Ratio**  75/25  50/50  30/70

**Max Range**  kilometers | min: 1 | max: 200

**Channel Bonding**  Disabled  Enabled

---

**Radio 1 SSID** PTP550-Master-1

**Radio 1 Channel Bandwidth**  20 MHz  40 MHz  80 MHz

**Radio 1 Frequency Carrier**

**Radio 2 SSID** PTP550-Master-2

**Radio 2 Channel Bandwidth**  20 MHz  40 MHz  80 MHz

**Radio 2 Frequency Carrier**

Attribute	Meaning
<b>Radio</b>	
Country	Defines the country code being used by the device. The country code of the Slave follows the country code of the associated Master, unless it is an FCC SKU in which case the country code is US. Country code defines the regulatory rules in use for the device.
Downlink/Uplink Ratio	The schedule of downlink traffic to uplink traffic on the radio link. The three options, <b>75/25</b> , <b>50/50</b> and <b>30/70</b> , allow the radio to operate in a fixed ratio on every frame. In other words, this ratio represents the amount of the total radio link's aggregate throughput that will be used for downlink resources, and the amount of the total radio link's aggregate throughput that will be used for uplink resources.
Max Range	This parameter represents cell coverage radius. Slaves outside the configured radius will not be able to connect. It is recommended to configure Max Range to match the actual physical distance of the farthest subscriber.
Channel Bonding	Disabled: The device uses one radio for data transmission. Enabled: The device uses two radios for data transmissions.
Radio 1/2 SSID	The SSID is used to identify the Master and is used to configure the Slave with the appropriate Master with which to register. Ensure that this parameter is configured uniquely for each Master in the network.

Attribute	Meaning
Radio 1/2 Channel Bandwidth	Configure the channel size used by the radio for RF transmission. This value may be configured independently for each configured channel on the Master and Slave.
Radio 1/2 Frequency Carrier	Configure the frequency carrier for RF transmission. This list is dynamically adjusted to the regional restrictions based on the setting of the <b>Country</b> parameter. Ensure that a thorough spectrum analysis has been completed prior to configuring this parameter.

## Installation wizard step 3 – Network parameters

### Installation

Cancel Setup Finish Setup

◀
Main
Radio
Network
Security
▶

Network

IP Assignment  Static  DHCP

**i** IP Address

Subnet Mask

Gateway

Preferred DNS Server

Alternate DNS Server

Attribute	Meaning
<b>Network</b>	
IP Assignment	<p><b>Static:</b> Device management IP addressing is configured manually in fields <b>IP Address, Subnet Mask, Gateway, Preferred DNS Server, and Alternate DNS Server.</b></p> <p><b>DHCP:</b> Device management IP addressing (<b>IP Address, Subnet Mask, Gateway, Preferred DNS Server and Alternate DNS Server</b>) is assigned via a network DHCP server, and parameters <b>IP Address, Subnet Mask, Gateway, Preferred DNS Server, and Alternate DNS Server</b> are not configurable.</p>
IP Address	<p>Internet protocol (IP) address. This address is used by the family of Internet protocols to uniquely identify this unit on a network.</p> <p> <b>Note</b></p> <p>If <b>IP Address Assignment</b> is set to <b>DHCP</b> and the device is unable to retrieve IP address information via DHCP, the device management IP is set to fallback IP 192.168.0.1 (Master Mode).</p>

Attribute	Meaning
Subnet Mask	Defines the address range of the connected IP network. For example, if Device IP Address (LAN) is configured to 192.168.2.1 and IP Subnet Mask (LAN) is configured to 255.255.255.0, the device will belong to subnet 192.168.2.X.
Gateway	Configure the IP address of the device on the current network that acts as a gateway. A gateway acts as an entrance and exit to packets from and to other networks.
Preferred DNS Server	Configure the primary IP address of the server used for DNS resolution.
Alternate DNS Server	Configure the secondary IP address of the server used for DNS resolution.

## Installation wizard step 4 – Security parameters

### Installation

Cancel Setup Finish Setup

◀ Main Radio Network Security ▶

Security

Wireless Security   
 Open   
 WPA2   
 RADIUS

WPA2 Pre-shared Key   

Servers       

IP Address	Port	Sec
Table is empty		

GUI User Authentication   
 Device Local Only   
 Remote RADIUS Server Only   
 Remote RADIUS Server and Fallback to Local

Attribute	Meaning
<b>Network</b>	
Wireless Security	<p>For Master mode devices, select the security mode enforced upon network entry. For Slave mode devices, select the security mode utilized upon network entry attempts.</p> <p><b>Open:</b> Slave devices attempting network entry are not subject to security mechanisms.</p> <p><b>WPA2:</b> The WPA2 mechanism provides AES radio link encryption and Slave network entry authentication. When enabled, the Slave must register using the Authentication Pre-shared Key configured on the Master and Slave.</p>



Attribute	Meaning
	<b>RADIUS:</b> Enables the connection to a pre-configured RADIUS server.
WPA2 Pre-shared Key	Configure this key on the Master, then configure the Slave with this key to complete the authentication configuration. This key must be between 8 to 128 symbols.
Servers	<p>For more Radio servers, click <b>Add</b>. Up to 3 Radius servers can be configured on the device with the following attributes:</p> <p><b>IP Address:</b> IP Address of the Radius server on the network.</p> <p><b>Port:</b> The Radius server port. Default is 1812.</p> <p><b>Secret:</b> Secret key that is used to communicate with the Radius server.</p>
GUI User Authentication	<p>This applies to both the Master and its registered Slave.</p> <p><b>Device Local Only:</b> The device's GUI authentication is local to the device using one of the accounts configured under <b>Configuration-&gt;System-&gt;Account Management</b>.</p> <p><b>Remote RADIUS Server Only:</b> The device's GUI authentication is performed using a RADIUS server.</p> <p><b>Remote RADIUS Server and Fallback to Local:</b> The device's GUI authentication is performed using a RADIUS server. Upon failure of authentication through a RADIUS server, the authentication falls back to one of the local accounts configured under <b>Configuration-&gt;System-&gt;Account Management</b>.</p>

## Using the installation wizard (Slave Mode)

The PTP 550 device features a guided configuration mechanism for configuring key parameters for link operation.

This setup is accessed on the **Installation** page by clicking the **Start Setup** button.

Start Setup

Click **Finish Setup** to commit the changes to the device.

### Installation wizard step 1 – Main system parameters

#### Installation

Cancel Setup Finish Setup

◀ Main Radio Network Security ▶

Main

Device Name \*

Radio Mode \*  Master  Slave

Attribute	Meaning
<b>Main</b>	
Device Name	The configured identifier used in an NMS such as cnMaestro
Radio Mode	<p><b>Master:</b> The unit controls the point-to-point link and its maintenance. On startup, the Master transmits until a link with the Slave is made.</p> <p><b>Slave:</b> The unit listens for its peer and only transmits when the peer has been identified.</p>

## Installation wizard step 2 – Radio parameters

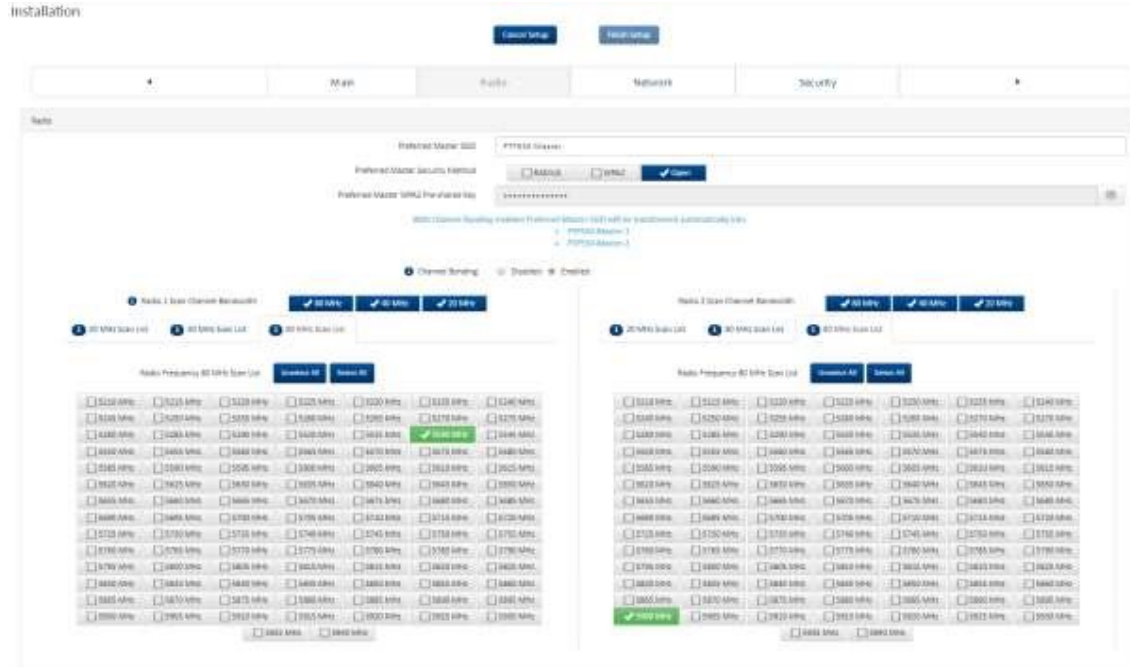

Attribute	Meaning
<b>Radio</b>	
Preferred Master SSID	The <b>Preferred Master SSID</b> defines the Master SSID to which the Slave device will attempt registration.
Preferred Master Security Method	Select the type of authentication preferred, whether RADIUS, WPA2, Open or a combination of the three.
Preferred Master WPA2 Pre-shared Key	The <b>Preferred Master WPA2 Pre-shared Key</b> must be configured on the Slave device to match the pre-shared key configured on the Master for registration with WPA2 security.
Channel Bonding	<b>Disabled:</b> The device uses one radio for data transmission. <b>Enabled:</b> The device uses two radios for data transmissions.
Radio 1/2 Scan Channel Bandwidth	Configure the channel size used by the radio for RF transmission. This value may be configured independently for each configured channel on the Master and Slave.
Radio 1/2 Frequency Scan List	Configure the frequency carrier for RF transmission. This list is dynamically adjusted to the regional restrictions based on the setting of the <b>Country</b> parameter. Ensure that a thorough spectrum analysis has been completed prior to configuring this parameter.

## Installation wizard step 3 – Network parameters

Attribute	Meaning
<b>Network</b>	
IP Assignment	<p><b>Static:</b> Device management IP addressing is configured manually in fields <b>IP Address</b>, <b>Subnet Mask</b>, <b>Gateway</b>, <b>Preferred DNS Server</b>, and <b>Alternate DNS Server</b>.</p> <p><b>DHCP:</b> Device management IP addressing (<b>IP Address</b>, <b>Subnet Mask</b>, <b>Gateway</b>, <b>Preferred DNS Server</b> and <b>Alternate DNS Server</b>) is assigned via a network DHCP server, and parameters <b>IP Address</b>, <b>Subnet Mask</b>, <b>Gateway</b>, <b>Preferred DNS Server</b>, and <b>Alternate DNS Server</b> are not configurable.</p>
IP Address	<p>Internet protocol (IP) address. This address is used by the family of Internet protocols to uniquely identify this unit on a network.</p> <p> <b>Note</b></p> <p>If <b>IP Address Assignment</b> is set to <b>DHCP</b> and the device is unable to retrieve IP address information via DHCP, the device management IP is set to fallback IP 192.168.0.2 (Slave Mode).</p>
Subnet Mask	Defines the address range of the connected IP network. For example, if Device IP Address (LAN) is configured to 192.168.2.1 and IP Subnet Mask (LAN) is configured to 255.255.255.0, the device will belong to subnet 192.168.2.X.
Gateway	Configure the IP address of the device on the current network that acts as a gateway. A gateway acts as an entrance and exit to packets from and to other networks.
Preferred DNS Server	Configure the primary IP address of the server used for DNS resolution.
Alternate DNS Server	Configure the secondary IP address of the server used for DNS resolution.

## Installation wizard step 4 – Security parameters

Installation

Main
Radio
Network
Security

Security

Wireless Security
 
 RADIUS
  WPA2
  Open

WPA2 Pre-shared Key

EAP-TTLS Username

Use Ethernet MAC Address as EAP-TTLS Username
 
 Off
  Using ':' as Format
  Using '-' as Format

EAP-TTLS Password

Authentication Identity String

Authentication Identity Realm

Attribute	Meaning
<b>Network</b>	
Wireless Security	Select the type of authentication preferred, whether <b>RADIUS</b> , <b>WPA2</b> , <b>Open</b> or a combination of the three.
WPA2 Pre-shared Key	Configure this key on the AP and then configure each of the network SMs with this key to complete the authentication configuration. This key must be between 8 to 128 symbols.
EAP-TTLS Username	Configure the EAP-TTLS Username to match the credentials on the RADIUS server being used for the network.
Use Ethernet MAC Address at EAP-TTLS Username	The device MAC Address can be used as the EAP-TTLS Username in either ":" or "-" delimited format.
EAP-TTLS Password	Configure the EAP-TTLS Password to match the credentials on the RADIUS server being used for the network.
Authentication Identity String	Configure this Identity string to match the credentials on the RADIUS server being used for the network. Default value for this parameter is "anonymous".
Authentication Identity Realm	Configure this Identity string to match the credentials on the RADIUS server being used for the network. Default value for this parameter is "cambiumnetworks.com".

## Using the menu options

Use the menu navigation bar in the left panel to navigate to each web page. Some of the menu options are only displayed for specific system configurations. Use [Table 35](#) to locate information about using each web page.

**Table 35** Menu options and web pages

Main menu	Menu option	Web page information
Status		<a href="#">Status page</a> on page 6-16
Installation		<a href="#">Installation page</a> on page 6-18
Configuration		<a href="#">Configuration menu</a> on page 6-19
	Radio	<a href="#">Configuration &gt; Radio page</a> on page 6-20
	System	<a href="#">Configuration &gt; System page</a> on page 6-24
	Network	<a href="#">Configuration &gt; Network page</a> on page 6-28
	Security	<a href="#">Configuration &gt; Security page</a> on page 6-34
Monitor		<a href="#">Monitor menu</a> on page 6-37
	Performance	<a href="#">Monitor &gt; Performance page</a> on page 6-38
	System	<a href="#">Monitor &gt; System page</a> on page 6-42
	Wireless	<a href="#">Monitor &gt; Wireless Page</a> on page 6-43
	Throughput Chart	<a href="#">Monitor &gt; Throughput Chart page</a> on page 6-47
	Network	<a href="#">Monitor &gt; Network page</a> on page 6-47
	System Log	<a href="#">Monitor &gt; System Log Page</a> on page 6-49
Tools		<a href="#">Tools menu</a> on page 6-50
	Software Upgrade	<a href="#">Tools &gt; Software Upgrade page</a> on page 6-50
	Backup / Restore	<a href="#">Tools &gt; Backup/Restore page</a> on page 6-51
	Spectrum Analyzer	<a href="#">Tools &gt; Spectrum Analyzer page</a> on page 6-52
	eAlign	<a href="#">Tools &gt; eAlign page</a> on page 6-53
	Wireless Link Test	<a href="#">Tools &gt; Wireless Link Test page</a> on page 6-55
	Ping	<a href="#">Tools &gt; Ping page</a> on page 6-56
	Traceroute	<a href="#">Tools &gt; Traceroute page</a> on page 6-57

## Status page

Figure 19 Status page (Master Mode)

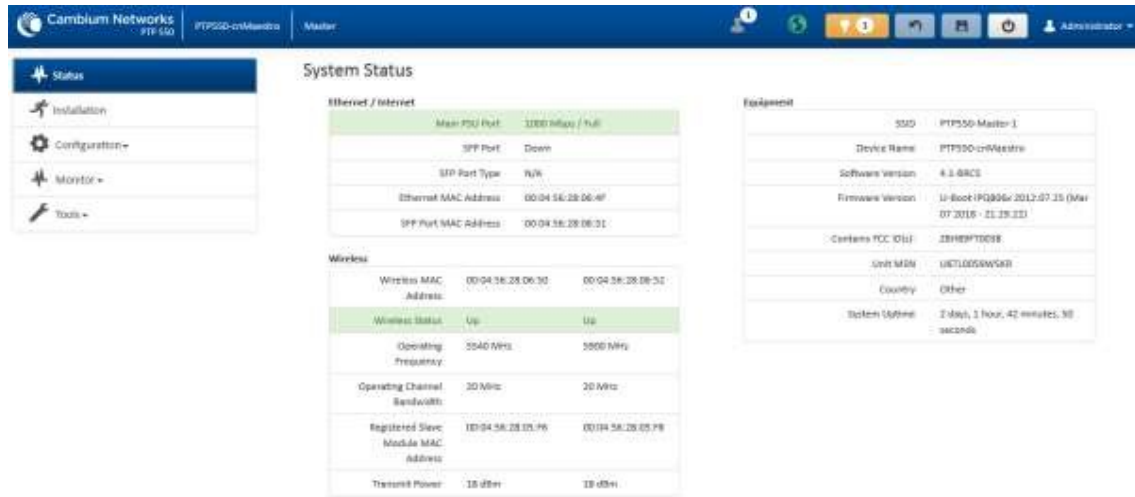

Figure 20 Status page (Slave Mode)

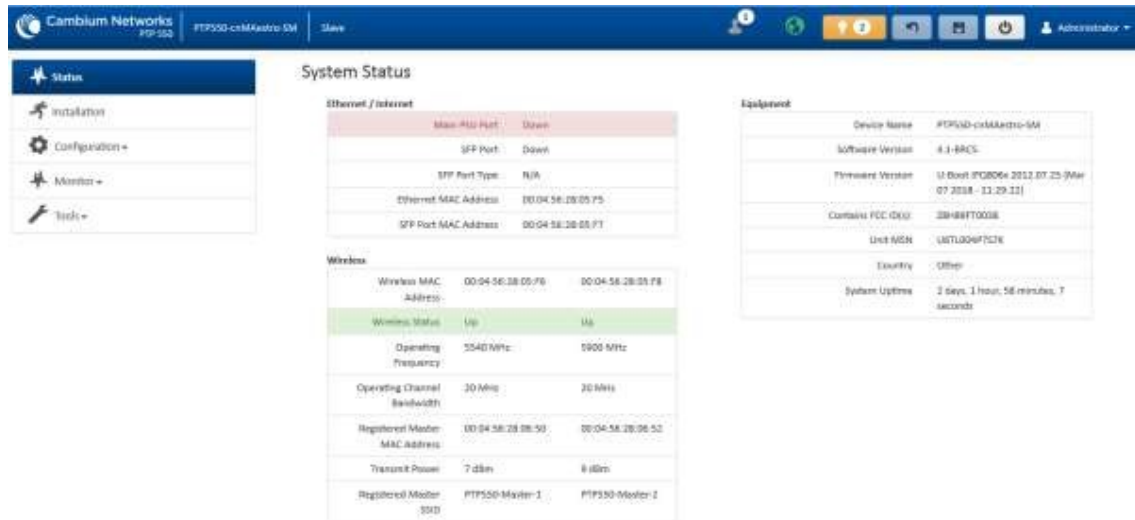

Table 36 Status page attributes

Attribute	Meaning
<b>Ethernet / Internet</b>	
Main PSU Port	Displays the current MAC Address and duplex mode to which the Ethernet port has auto-negotiated, or displays the current port speed and duplex mode that have been configured manually.
SFP Port	Displays the current port speed and duplex mode to which the SFP port has auto-negotiated, or displays the current port speed and duplex mode that have been configured manually.
SFP Port Type	Displays the type of SFP module connected to the device.

Attribute	Meaning
Ethernet MAC Address	The hardware address of the device LAN (Ethernet) interface.
SFP Port MAC Address	The hardware address of the device SFP LAN interface.
<b>Wireless</b>	
Wireless MAC Address	MAC address is a unique identifier assigned to ath0/eth0 interface for communication on the physical network segment. The Wireless MAC address is always one greater than the Ethernet MAC Address.
Wireless Status (Master Mode)	<b>Up:</b> The device wireless interface is functioning and sending beacons. <b>Down:</b> The device wireless interface has encountered an error disallowing full operation. Reset the device to reinitiate the wireless interface.
Wireless Status (Slave Mode)	<b>Up:</b> The device wireless interface is functioning and the device has completed network entry. <b>Down:</b> The device wireless interface has encountered an error disallowing full operation. Evaluate radio and security configuration on the Master and Slave device to determine the network entry failure.
Operating Frequency	Indicates the current operating frequency for each radio interface.
Registered Slave Module MAC Address (Master Mode)	Indicates the MAC address of the Slave PTP registered to the device.
Registered Master MAC Address (Slave Mode)	Indicates the MAC address of the Master PTP to which the Slave is registered.
Transmit Power	The total transmit power corresponding to each radio interface. The Slave has two transmit chains for each channel and total transmit power sums the power from both chains. This does not include antenna gain. Transmitter Output Power may be limited by regulatory rules for the country in use.
Registered Master SSID	Indicates the SSID of each radio interface of the Master to which the Slave is registered.
<b>Equipment</b>	
SSID (Master Mode)	SSID is a unique identifier for a wireless LAN which is specified in the Master's beacon. SSID must be same at both ends and different to site name.
Device Name	The configured identifier used in an NMS such as cnMaestro.
Software Version	The currently operating version of software on the device.
Firmware Version	U-boot software is used to boot and then invokes the software used for the device. This specifies the u-boot version number used on the device.
Contains FCC ID(s)	FCC ID of the device.



Attribute	Meaning
Unit MSN	Unit serial number.
Country	Defines the country code being used by the device. The country code of the Slave follows the country code of the associated Master, unless it is a SKU in which case the country code is United States or Canada. Country code defines the regulatory rules in use for the device.
System Uptime	The total uptime of the radio since the last reset.

## Installation page

Figure 21 Installation page



Table 37 Installation page attributes

Attribute	Meaning
<p>Start Setup</p> 	The installation page features a guided setup option <b>Start Setup</b> to configure key parameters for link operation. See section <a href="#">Using the installation wizard</a> on page 6-6 for more information.
<b>Main</b>	
Radio Mode	<p><b>Master:</b> The unit controls the point-to-point link and its maintenance. On startup, the Master transmits until a link with the Slave is made.</p> <p><b>Slave:</b> The unit listens for its peer and only transmits when the peer has been identified.</p>
SSID (Master Mode)	SSID is a unique identifier for a wireless LAN which is specified in the Master's beacon. (Master Mode). SSID must be same at both ends and different to site name.
Device Name	The configured identifier used in an NMS such as cnMaestro
Wireless Security	For Master mode devices, select the security mode enforced upon network entry. For Slave mode devices, select the security mode utilized upon network entry attempts.

Attribute	Meaning
	<p><b>Open:</b> Slave devices attempting network entry are not subject to security mechanisms.</p> <p><b>WPA2:</b> The WPA2 mechanism provides AES radio link encryption and Slave network entry authentication. When enabled, the Slave must register using the Authentication Pre-shared Key configured on the Master and Slave.</p> <p><b>RADIUS:</b> Enables the connection to a pre-configured RADIUS server.</p>
Country	Defines the country code being used by the device. The country code of the Slave follows the country code of the associated BHM, unless it is an FCC SKU in which case the country code is US. Country code defines the regulatory rules in use for the device.
<b>Radio</b>	
Operating Frequency	The current frequency at which the radio interface is operating.
Operating Channel Bandwidth	The current channel size at which the radio interface is operating.
<b>Network</b>	
IP Assignment	<p><b>Static:</b> Device management IP addressing is configured manually in fields <b>IP Address, Subnet Mask, Gateway, Preferred DNS Server, and Alternate DNS Server</b>.</p> <p><b>DHCP:</b> Device management IP addressing (IP address, Subnet Mask, Gateway, and DNS Server) is assigned via a network DHCP server, and parameters <b>IP Address, Subnet Mask, Gateway, Preferred DNS Server, and Alternate DNS Server</b> are not configurable.</p>
IP Address	<p>Internet protocol (IP) address. This address is used by the family of Internet protocols to uniquely identify this unit on a network.</p> <p> <b>Note</b></p> <p>If <b>IP Address Assignment</b> is set to <b>DHCP</b> and the device is unable to retrieve IP address information via DHCP, the device management IP is set to fallback IP 192.168.0.1 (Master) or 192.168.0.2 (Slave).</p>
Subnet Mask	Defines the address range of the connected IP network. For example, if Device IP Address (LAN) is configured to 192.168.2.1 and IP Subnet Mask (LAN) is configured to 255.255.255.0, the device will belong to subnet 192.168.2.X.

## Configuration menu

Use the **Configuration** menu to access all applicable device configuration parameters.

## Configuration > Radio page

Figure 22 Configuration > Radio page (Master Mode)

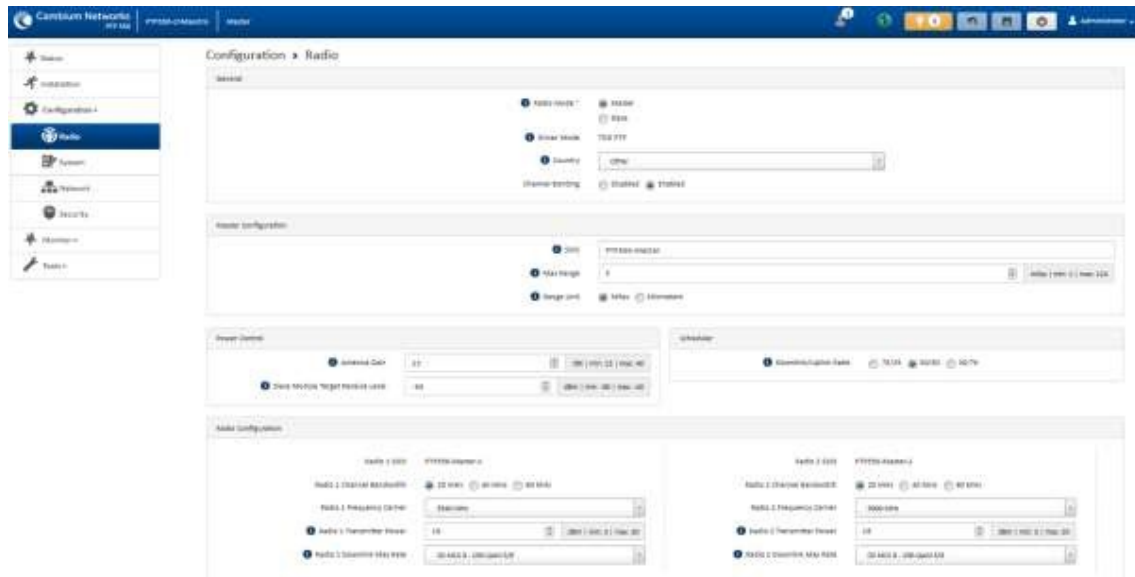

Figure 23 Configuration > Radio page (Slave Mode)

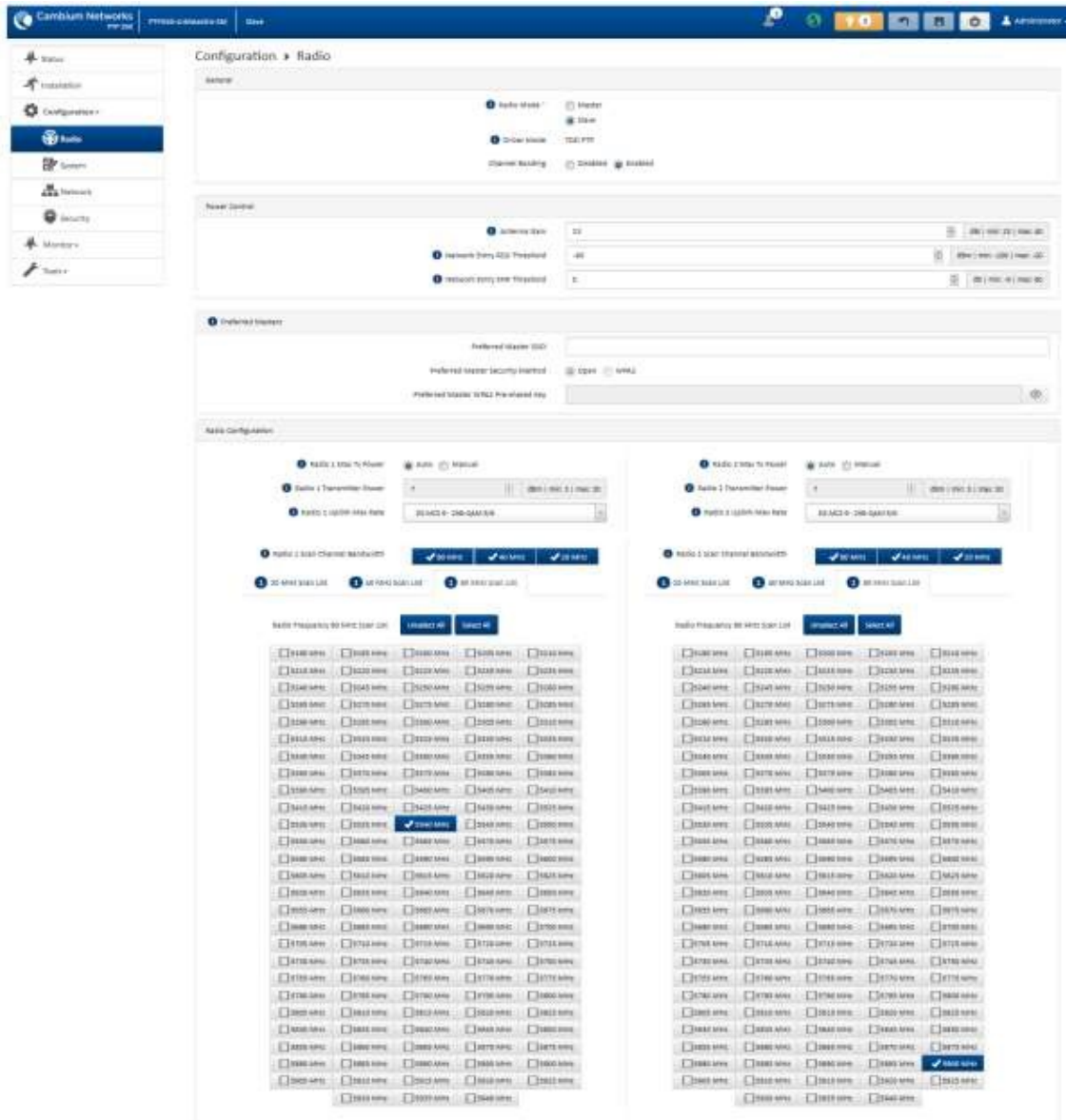

Table 38 Configuration > Radio page attributes

Attribute	Meaning
<b>General</b>	
Radio Mode	<p><b>Master:</b> The unit controls the point-to-point link and its maintenance. On startup, the Master transmits until a link with the Slave is made.</p> <p><b>Slave:</b> The unit listens for its peer and only transmits when the peer has been identified.</p>
Driver Mode	<p><b>TDD PTP:</b> The Master is operating in point-to-point (PTP) mode using TDD scheduling.</p>

Attribute	Meaning
Country (Master Mode only)	Defines the country code being used by the device. The country code of the Slave follows the country code of the associated BHM, unless it is an FCC SKU in which case the country code is US. Country code defines the regulatory rules in use for the device.
Channel Bonding	Disabled: The device uses one radio for data transmission. Enabled: The device uses two radios for data transmissions.
<b>Master Configuration (Master Mode only)</b>	
SSID (Master Mode only)	SSID is a unique identifier for a wireless LAN which is specified in the Master's beacon. (Master Mode).
Max Range	This parameter represents cell coverage radius. Slaves outside the configured radius will not be able to connect. It is recommended to configure Max Range to match the actual physical distance of the farthest subscriber.
Range Unit	Units of measurement on the device are displayed in either miles (m) or kilometers (km).
<b>Preferred Masters (Slave Mode only)</b>	
Preferred Master SSID	Once an entry is added, the Slave will only register to the Master SSID listed in <b>Preferred Master SSID</b> with the security methods and credentials defined in <b>Preferred Master Security Method</b> and <b>Preferred Master WPA2 Pre-shared Key</b> .
Preferred Master Security Method	Select the type of authentication preferred, whether RADIUS, WPA2, Open or a combination of the three.
Preferred Master WPA2 Pre-shared Key	The <b>Preferred Master WPA2 Pre-shared Key</b> must be configured on the Slave device to match the pre-shared key configured on the Master for registration with WPA2 security.
<b>Slave Module Scanning (Slave Mode only)</b>	
Scan Channel Bandwidth Radio 1/2 (Slave Mode only)	The selected scan channel bandwidths are scanned by the Slave. Any combination may be selected. When a bandwidth is selected, a tab for the bandwidth appears and a listing of all available channels is presented once the tab for the bandwidth is selected. Each bandwidth tab may contain a number on the left side. This number defines how many channels have been selected for that bandwidth. If no channels are selected for a bandwidth, then all channels are scanned.
<b>Power Control</b>	
Max Tx Power (Slave Mode only)	<b>Auto:</b> The Master can control, using ATPC (Automatic Transmit Power Control), the TX power of the Slave up to the maximum capability of the Slave's transmitter (based on regulatory limits). <b>Manual:</b> The Master can control the TX power of the Slave up to the value configured in the <b>Transmitter Power</b> field.

Attribute	Meaning
Antenna Gain	The total gain of the antenna in use by the device. For integrated devices, this parameter defaults to 25 dBi.
Slave Module Target Receive Level (Master Mode only)	Defines the desired receive power level at the Master from registered Slave. Masters use this parameter to control the transmission power of the Slave in order to reduce system self-interference.
Network Entry RSSI Threshold (Slave Mode only)	This defines the Downlink RSSI threshold below which a Slave will not register to a Master.
Network Entry SNR Threshold (Slave Mode only)	This defines the Downlink Signal-to-Noise-Ratio (SNR) threshold below which the Slave will not register to a Master.
<b>Scheduler</b>	
Downlink/Uplink Ratio (Master Mode only)	The schedule of downlink traffic to uplink traffic on the radio link. The three options, <b>75/25</b> , <b>50/50</b> and <b>30/70</b> , allow the radio to operate in a fixed ratio on every frame. In other words, this ratio represents the amount of the total radio link's aggregate throughput that will be used for downlink resources, and the amount of the total radio link's aggregate throughput that will be used for uplink resources.
<b>Radio Configuration</b>	
Radio 1/2 SSID	Indicates the current configured SSID for each radio interface.
Radio 1/2 Channel Bandwidth (Master Mode only)	Configure the channel size used by the radio for RF transmission. This value may be configured independently for each configured channel on the Master and Slave.
Radio 1/2 Frequency Carrier (Master Mode only)	Configure the frequency carrier for RF transmission. This list is dynamically adjusted to the regional restrictions based on the setting of the <b>Country</b> parameter. Ensure that a thorough spectrum analysis has been completed prior to configuring this parameter.
Radio 1/2 Transmitter Power	The total transmit power of Radio 1 or two. The device has two transmit chains for each channel and total transmit power sums the power from both chains. This does not include antenna gain. Transmitter Output Power may be limited by regulatory rules for the country in use.
Radio 1/2 Uplink Max Rate (Slave Mode only)	Specifies the maximum uplink MCS value that the Rate Adapt algorithm will choose for Radio 1. If a deployment is exhibiting packet loss due to downlink interference, modifying <b>Uplink Max Rate</b> to limit the device maximum MCS rate may result in more reliable packet delivery. This is especially true in deployments among changing and unpredictable interference.
Radio 1/2 Downlink Max Rate (Master Mode only)	Specifies the maximum downlink MCS value that the Rate Adapt algorithm will choose for Radio 1. If a deployment is exhibiting packet loss due to downlink interference, modifying <b>Downlink Max Rate</b> to limit the device maximum MCS rate may result in more reliable packet delivery. This is especially true in deployments among changing and unpredictable interference.

## Configuration > System page

Figure 24 Configuration > System page

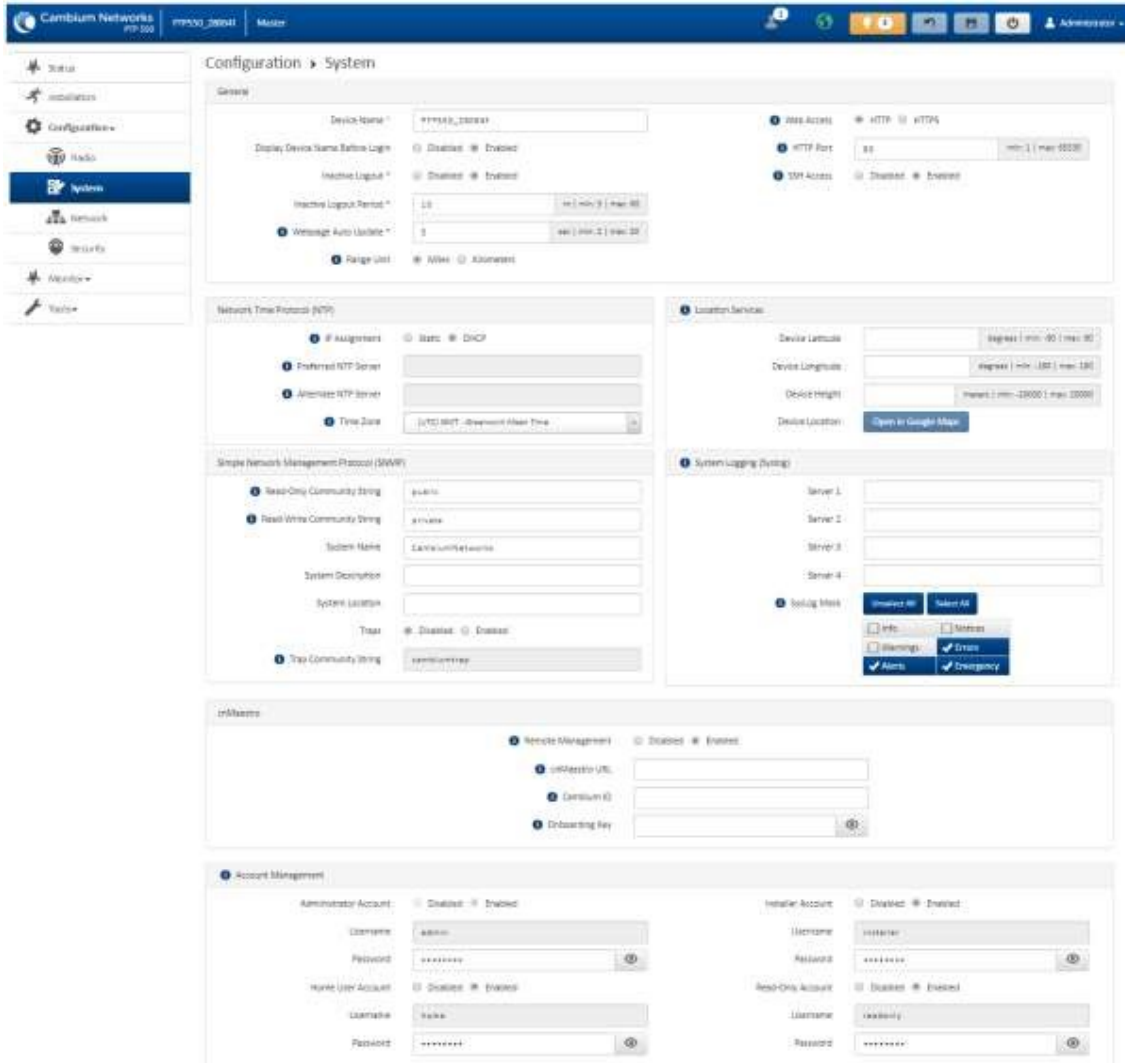







Table 39 Configuration > System page attributes

Attribute	Meaning
<b>General</b>	
Device Name	The configured identifier used in an NMS such as cnMaestro.
Display Device Name Before Login	<b>Disabled:</b> For security, the configured <b>Device Name</b> is hidden on the device login screen. <b>Enabled:</b> The configured <b>Device Name</b> is displayed upper-left on the device login screen.
Inactive Logout	<b>Enabled:</b> The device web management interface will force a logout after the time period configured in <b>Inactive Logout Period</b> has lapsed.

Attribute	Meaning
	<b>Disabled:</b> The device web management interface will not force a logout for the current user.
Inactive Logout Period	When <b>Inactive Logout</b> is set to <b>Enabled</b> , this parameter indicates the number of minutes for which the user will remain logged in to the web management interface. Once the period has lapsed, the user must login again to gain access to the web management interface.
Webpage Auto Update	Configure the interval for which the device retrieves system statistics for display on the management interface. For example, if this setting is configured to 5 seconds, the statistics and status parameters displayed on the management interface will be refreshed every 5 seconds (default). <b>Webpage Auto Update is a session only configuration change. It is updated with the &lt;Enter&gt; key and is not savable when using the save button.</b>
Range Unit	Units of measurement on the device are displayed in either miles (m) or kilometers (km).
Web Access	<b>HTTP:</b> The device web management interface is accessed via HTTP. <b>HTTPS:</b> The device web management interface may only be accessed via secure HTTPS.
HTTP Port	This specifies the TCP/UDP port to be used with HTTP or HTTPS. The default value for HTTP is 80 and for HTTPS is 443.
SSH Access	<b>Disabled:</b> Access to the device through SSH is not possible. <b>Enabled:</b> Cambium engineers can access the device through SSH which enables them to login to the radio and troubleshoot. <b>SSH Access is Enabled</b> by default.
<b>Network Time Protocol (NTP)</b>	
IP Assignment	<b>Static:</b> The device retrieves NTP time data from the servers configured in fields NTP Server IP Address. <b>DHCP:</b> The device retrieves NTP time data from the server IP issued via a network DHCP server.
Preferred NTP Server	Configure the primary NTP server IP addresses from which the device will retrieve time and date information.
Alternate NTP Server	Configure an alternate or secondary NTP server IP addresses from which the device retrieves time and date information.
Time Zone	The Time Zone option may be used to offset the received NTP time to match the operator's local time zone.
<b>Location Services</b>	
Device Latitude	Configure Latitude information for the device in decimal format.
Device Longitude	Configure Longitude information for the device in decimal format.
Device Height	Configure height above sea level for the device in meters.
Device Location	Hyperlink to display the device location in Google Maps
	<a href="#">Open in Google Maps</a>



Attribute	Meaning
<b>Simple Network Management Protocol (SNMP)</b>	
Read-Only Community String	Specify a control string that can allow a Network Management Station (NMS) to read SNMP information. No spaces are allowed in this string. This password will never authenticate an SNMP user or an NMS to read/write access.  The <b>Read-only Community String</b> value is clear text and is readable by a packet monitor.
Read-Write Community String	Specify a control string that can allow a Network Management Station (NMS) to access SNMP information. No spaces are allowed in this string.
System Name	Specify a string to associate with the physical module. This parameter can be polled by the NMS. Special characters are supported.
System Description	Specify a description string to associate with the physical module. This parameter can be polled by the NMS. Special characters are supported.
System Location	Specify a description string to associate with the physical location. This parameter can be polled by the NMS. Special characters are supported.
Traps	<b>Disabled:</b> SNMP traps for system events are not sent from the device. <b>Enabled:</b> SNMP traps for system events are sent to the servers configured in table <b>Trap Servers</b> .
Trap Community String	Configure a SNMP Trap Community String which is processed by the servers configured in <b>Trap Servers</b> . This string is used by the trap server to decide whether or not to process the traps incoming from the device (i.e. for traps to successfully be received by the trap server, the community string must match).
<b>System Logging (Syslog)</b>	
Server 1-4	Specify up to four syslog servers to which the device sends syslog messages.
Syslog Mask	Configure the levels of syslog messages which the devices send to the servers configured in parameters <b>Server 1-4</b> .   <b>Caution</b>  Choose only the syslog levels appropriate for your deployment. Excessive logging can cause the device log file to fill and begin overwriting previous entries.
<b>cnMaestro</b>	
Remote Management	When <b>Enabled</b> , the device will be managed by cnMaestro - the Cambium Remote Management System, which allows all Cambium devices to be managed in the cloud.
cnMaestro URL	Configure the URL of cnMaestro. The default value is <a href="https://cloud.cambiumnetworks.com">https://cloud.cambiumnetworks.com</a> .
Cambium ID	Configure the Cambium ID that the device will use for on-boarding on to cnMaestro.
Onboarding Key	Configure the password/key associated with the <b>Cambium-ID</b> that the device will use for on-boarding on to cnMaestro.

Attribute	Meaning
<b>Account Management</b>	
Administrator Account	<p>The Administrator account has full read and write permissions for the device.</p> <p><b>Disabled:</b> The disabled user is not granted access to the device management interface. The administrator user level cannot be disabled.</p> <p><b>Enabled:</b> The user is granted access to the device management interface.</p>
Username	The username associated with the administrator account, used upon device login.
Password	<p>Configure a custom password to secure the device. Only 'Administrator' account can override this password. The password character display may be toggled using the visibility icon .</p>
Installer Account	<p>The Installer account has permissions to read and write parameters applicable to unit installation and monitoring.</p> <p><b>Disabled:</b> The disabled user is not granted access to the device management interface.</p> <p><b>Enabled:</b> The user is granted access to the device management interface.</p>
Username	The username associated with the installer account, used upon device login.
Password	<p>Configure a custom password to secure the device. Only 'Administrator' account can override this password. The password character display may be toggled using the visibility icon .</p>
Home User Account	<p>The Home User account has permissions to access pertinent information for support purposes.</p> <p><b>Disabled:</b> The disabled user is not granted access to the device management interface.</p> <p><b>Enabled:</b> The user is granted access to the device management interface.</p>
Username	The username associated with the home user account, used upon device login.
Password	<p>Configure a custom password to secure the device. Only 'Administrator' account can override this password. The password character display may be toggled using the visibility icon .</p>
Read-Only Account	<p>The Read-Only account has permissions to view the <b>Monitor</b> page only.</p> <p><b>Disabled:</b> The disabled user is not granted access to the device management interface.</p> <p><b>Enabled:</b> The user is granted access to the device management interface.</p>
Username	The username associated with the read-only account, used upon device login.
Password	<p>Configure a custom password to secure the device. Only 'Administrator' account can override this password. The password character display may be toggled using the visibility icon .</p>

## Configuration > Network page

Figure 25 Configuration > Network page (Master Mode)

The screenshot displays the Cambium Networks PTAC configuration interface for the Network page. The interface is organized into several sections:

- General:**
  - IP Assignment:  Static  DHCP
  - IP Address: 10.122.222.28
  - Subnet Mask: 255.255.252.0
  - Gateway: 10.122.222.254
  - Preferred DNS Server: 10.122.22.169
  - Alternate DNS Server: 10.122.11.11
- Virtual Local Area Network (VLAN):**
  - Management VLAN:  Disabled  Enabled
  - Management VLAN ID: 1000 (min: 0 | max: 4095)
  - Management VLAN Priority: 100 (min: 0 | max: 7)
- Advanced:**
  - IPv6 Support:  Disabled  Enabled
  - Spanning Tree Protocol:  Disabled  Enabled
  - Management Access:  Ethernet  Ethernet And Wireless
  - DHCP Option 82:  Disabled  Enabled
  - LLDP:  Disabled  Enabled
  - LLDP Mode:  Receive and Transmit  Receive only
- Ethernet Port:**
  - Ethernet MTU: 1518 (min: 576 | max: 1518)
  - Port Setting:  Manual  Auto-Negotiate
  - Port Speed:  10M  100M  1000M
  - Port Duplex Mode:  Half  Full
- SPF Port:**
  - SPF Port:  Disabled  Enabled
- Broadcast/Multicast Traffic Forwarding:**
  - Broadcast Packet Limit:  Disabled  Enabled
  - Broadcast Packet Rate: 224 (min: 100 | max: 24000)

Figure 26 Configuration &gt; Network page (Slave Mode)

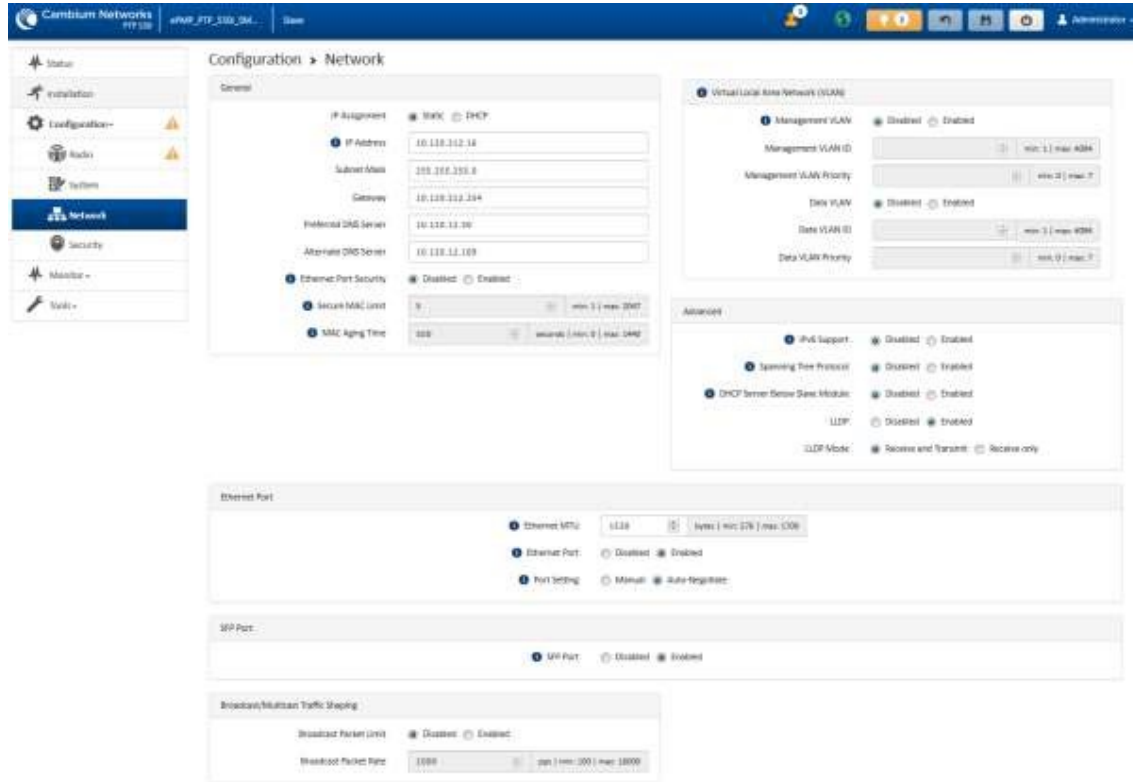



Table 40 Configuration &gt; Network page attributes

Attribute	Meaning
<b>General</b>	
IP Assignment	<p><b>Static:</b> Device management IP addressing is configured manually in fields <b>IP Address</b>, <b>Subnet Mask</b>, <b>Gateway</b>, <b>Preferred DNS Server</b>, and <b>Alternate DNS Server</b>.</p> <p><b>DHCP:</b> Device management IP addressing (IP address, Subnet Mask, Gateway, and DNS Server) is assigned via a network DHCP server, and parameters <b>IP Address</b>, <b>Subnet Mask</b>, <b>Gateway</b>, <b>Preferred DNS Server</b>, and <b>Alternate DNS Server</b> are not configurable.</p>
IP Address	<p>Internet protocol (IP) address. This address is used by the family of Internet protocols to uniquely identify this unit on a network.</p> <p> <b>Note</b> If <b>IP Address Assignment</b> is set to <b>DHCP</b> and the device is unable to retrieve IP address information via DHCP, the device management IP is set to fallback IP 192.168.0.1 (Master) or 192.168.0.2 (Slave).</p>
Subnet Mask	<p>Defines the address range of the connected IP network. For example, if Device IP Address (LAN) is configured to 192.168.2.1 and IP Subnet Mask (LAN) is configured to 255.255.255.0, the device will belong to subnet 192.168.2.X.</p>

Attribute	Meaning
Gateway	Configure the IP address of the device on the current network that acts as a gateway. A gateway acts as an entrance and exit to packets from and to other networks.
Preferred DNS Server	Configure the primary IP address of the server used for DNS resolution.
Alternate DNS Server	Configure the secondary IP address of the server used for DNS resolution.
IPv6 Assignment	<p><b>IPv6 Assignment</b> specifies how the IPv6 address is obtained.</p> <p><b>Static:</b> Device management IP addressing is configured manually in fields <b>IPv6 Address</b> and <b>IPv6 Gateway</b>.</p> <p><b>DHCPv6:</b> Device management IP addressing (IP address and gateway) is assigned via a network DHCP server, and parameters <b>IPv6 Address</b> and <b>IPv6 Gateway</b> are unused. If the DHCPv6 server is not available previous static IPv6 address will be used as a fallback IPv6 address. If no previous static IPv6 address is available, no IPv6 address will be assigned. DHCPv6 will occur over the wireless interface by default.</p>
IPv6 Address	<p>Internet protocol version 6 (IPv6) address. This address is used by the family of Internet protocols to uniquely identify this unit on a network.</p> <p>IPv6 addresses are represented by eight groups of four hexadecimal digits separated by colons.</p>
IPv6 Gateway	Configure the IPv6 address of the device on the current network that acts as a gateway. A gateway acts as an entrance and exit to packets from and to other networks.
Ethernet Port Security (Slave Mode only)	<p><b>Disabled:</b> No MAC address limit / gaining timers are imposed for bridging at the Slave device Ethernet port.</p> <p><b>Enabled:</b> By configuring <b>Secure MAC Limit</b> and <b>MAC Aging Time</b>, a limit is imposed on the number and duration of bridged devices connected to the Slave Ethernet port.</p>
Secure MAC Limit (Slave Mode only)	Configure the number of simultaneous secure MAC addresses that will be allowed at the Ethernet interface of the Slave
MAC Aging Time (Slave Mode only)	Configure the time for which the secure MAC addresses should be allowed to age. Once the Aging timer expires for a MAC address, it will be removed from the internal table and no longer count as an active MAC. Set the time to 0 to disable aging.
<b>Virtual Local Area Newtork (VLAN)</b>	
Management VLAN	<b>Enabled:</b> The device management interface can be assigned to a Management VLAN to separate management traffic (remote module management via SNMP or HTTP) from user traffic (such as internet browsing, voice, or video. Once the management interface is enabled for a VLAN, the management interface can be accessed only by packets tagged with a VLAN ID matching the management VLAN ID.

Attribute	Meaning
	<p>A VLAN configuration establishes a logical group within the network. Each computer in the VLAN, regardless of initial or eventual physical location, has access to the same data based on the VLAN architecture. For the network operator, this provides flexibility in network segmentation, simpler management and enhanced security.</p> <p><b>Disabled:</b> When disabled, all IP management traffic is allowed to the device.</p>
Management VLAN ID	<p>Configure this parameter to include the device's management traffic on a separate VLAN network. For example, if <b>Management VLAN ID</b> is set to 2, GUI access will only be allowed from frames tagged with VLAN ID 2. This parameter only takes effect if the MGMT VLAN parameter is enabled.</p>
Management VLAN Priority	<p>PTP 550 devices can prioritize VLAN traffic based on the eight priorities described in the IEEE 802.1p specification. <b>Management VLAN Priority</b> represents the VLAN Priority or Class of Service (CoS). Operators may use this prioritization field to give precedence to device management traffic.</p> <p><b>This parameter only takes effect if the Management VLAN parameter is enabled. Configure this parameter to set the value of the Priority code point field in the 802.1q tag for traffic on the management VLAN originating from the Slave Module. The default value is 0.</b></p>
Data VLAN (Slave Mode only)	<p><b>Enabled:</b> A VLAN tag will be added to all untagged traffic entering the Slave device LAN port before sending it to the Master and remove tags in the opposite direction from traffic (tagged with Data VLAN ID) entering on the Slave device WAN port before sending to the Slave device LAN port.</p> <p><b>Disabled:</b> When disabled, no changes are made to untagged traffic passing through the Slave device.</p>
Data VLAN ID (Slave Mode only)	<p>Configure this parameter to include this VLAN tag to all untagged traffic entering on the Slave device LAN port before sending it to the Master device and remove tags in the opposite direction from traffic (tagged with Data VLAN ID) entering on the Slave device WAN port before sending to the Slave device LAN port.</p>
Data VLAN Priority (Slave Mode only)	<p>PTP 550 devices can prioritize VLAN traffic based on the eight priorities described in the IEEE 802.1p specification. <b>Data VLAN Priority</b> represents the VLAN Priority or Class of Service (CoS). Operators may use this prioritization field to give precedence to device user data.</p> <p>This parameter only takes effect if the <b>Data VLAN</b> parameter is enabled. Configure this parameter to set the value of the Priority code point field in the 802.1q tag for traffic on the <b>Data VLAN</b> originating from the Slave device. The default value is 0.</p>
<b>Advanced</b>	
IPv6 Support	<p>Systemwide IPv6 Protocol Support. When enabled, appropriate IPv6 modules and services will be loaded.</p>
Spanning Tree Protocol	<p><b>Disabled:</b> When disabled, Spanning Tree Protocol (802.1d) functionality is disabled at the Master.</p> <p><b>Enabled:</b> When enabled, Spanning Tree Protocol (802.1d) functionality is enabled at the Master, allowing for prevention of Ethernet bridge loops.</p>

Attribute	Meaning
DHCP Server Below Slave Module (Slave Mode only)	<p><b>Disabled:</b> This blocks DHCP servers connected to the Slave device LAN side from handing out IP addresses to DHCP clients above the Slave device (wireless side).</p> <p><b>Enabled:</b> This allows DHCP servers connected to the Slave device LAN side to assign IP addresses to DHCP clients above the Slave device (wireless side). This configuration is typical in PTP links.</p>
Management Access (Master Mode only)	<p><b>Ethernet:</b> Only allow access to the Master's web management interface via a local Ethernet (LAN) connection. In this configuration, the Master's web management interface may not be accessed from over the air (i.e. from a device situated below the Slave).</p> <p><b>Ethernet and Wireless:</b> Allow access to the Master's web management interface via a local Ethernet (LAN) connection and from over the air (i.e. from a device situated below the Slave).</p> <hr/> <p> Caution</p> <p>Masters configured with Management Access Interface set to Ethernet and Ethernet and Wireless are susceptible to unauthorized access.</p>
DHCP Option 82 (Master Mode only)	<p><b>Disabled:</b> The device does not insert the "remote-id" (option ID 0x2) and the "circuit-id" (ID 0x01). DHCP Option 82 is 'Disabled' by default.</p> <p><b>Enabled:</b> The device inserts "remote-id" (option ID 0x2) to be the Slave MAC address and the "circuit-id" (ID 0x01) to be the Master's MAC address. Those two fields are used to identify the remote device and connection from which the DHCP request was received.</p>
LLDP	<p>The Link Layer Discovery Protocol (LLDP) is a vendor-neutral link layer protocol (as specified in IEEE 802.1AB) used by the device for advertising its identity, capabilities, and neighbors on the Ethernet/wired interface.</p> <p><b>Disabled:</b> The device does not receive or transmit LLDP packets from/to its neighbors.</p> <p><b>Enabled:</b> The device can receive LLDP packets from its neighbors and send LLDP packets to its neighbors, depending on the LLDP Mode configuration.</p>
LLDP Mode	<p><b>Receive and Transmit:</b> The device sends and receives LLDP packets to/from its neighbors on the Ethernet/LAN interface.</p> <p><b>Receive Only:</b> The device receives LLDP packets from its neighbors on the Ethernet/LAN interface and discovers them.</p>
Ethernet Port	
Ethernet MTU	<p>Specify the device MTU or Maximum Transmission Unit; the size in bytes of the largest data unit that the device is configured to process. Larger MTU configurations can enable the network to operate with greater efficiency, but in the case of retransmissions due to packet errors, efficiency is reduced since large packets must be resent in the event of an error.</p>
Ethernet Port (Slave Mode only)	<p><b>Disabled:</b> The primary Ethernet port is disabled (a mechanism for restricting access for non-payment).</p> <p><b>Enabled:</b> The primary Ethernet port is enabled.</p>

Attribute	Meaning
Port Setting	<p>Allows the Gigabit Ethernet port duplex settings and port speed to be either manually configured or auto-negotiated with the connected ethernet device on the other end of the link.</p> <p>Guidelines for using <b>Port Setting</b>:</p> <ol style="list-style-type: none"> <li>1. When auto-negotiation is turned on, this applies to both <b>Port Speed</b> and <b>Port Duplex Mode</b>.</li> <li>2. If the other end of the ethernet connection supports auto-negotiation, then <b>Auto-Negotiate</b> should be selected.</li> <li>3. If the other end of the ethernet connection does not support auto-negotiation, then <b>Manual</b> should be selected and both ends of the link should manually set the port speed and port duplex mode.</li> </ol>
Port Speed	With <b>Port Setting</b> configured to <b>Manual</b> , the Gigabit Ethernet port speed can be forced to 1000 Mbps, 100 Mbps or 10 Mbps.
Port Duplex Mode	With <b>Port Setting</b> configured to <b>Manual</b> , the Gigabit Ethernet port duplex mode can be forced to <b>Full</b> or <b>Half</b> .
<b>SFP Port</b>	
SFP Port	<p><b>Disabled:</b> The SFP port is inactive.</p> <p><b>Enabled:</b> The SFP port is active.</p>



## Configuration > Security page

The **Security** page is used to configure system security features including authentication and Layer2/Layer3 Firewall rules.



### Caution

If a device firewall rule is added with **Action** set to **Deny** and **Interface** set to **LAN** or **WAN** and no other rule attribute are configured, the device will drop all Ethernet or wireless traffic, respectively. Ensure that all firewall rules are specific to the type of traffic which must be denied, and that no rules exist in the devices with only **Action** set to **Deny** and **Interface** set to **LAN** or **WAN**. To regain access to the device, perform a factory default.

**Figure 27** Configuration > Security page (Master)

The screenshot displays the 'Configuration > Security' page in a web browser. The top navigation bar shows 'Cambium Networks PTP 510' and 'ePMP\_PTP\_510\_AP\_01 Master'. The left sidebar has 'Security' highlighted. The main content area is titled 'Configuration > Security' and contains several sections:

- Security Options:** Includes a radio button for 'Wireless Security' (selected), and options for 'Open', 'WPA2', and 'RADIUS'.
- WPA2:** Features a 'WPA2 Pre-shared key' field with a masked password and a visibility toggle.
- RADIUS:** Contains a 'Servers' table (empty), 'Server Radius' and 'Server Timeout' input fields, and radio buttons for 'All User Authentication' (selected), 'Device Local Only', 'Remote RADIUS Server Only', and 'Remote RADIUS Server and fallback to Local'.
- Firewalls:** Divided into 'Layer 2 Firewall' and 'Layer 3 Firewall'. Each section has 'Add' and 'Show List' buttons and a 'Table is empty' message.

**Figure 28** Configuration > Security page (Slave)

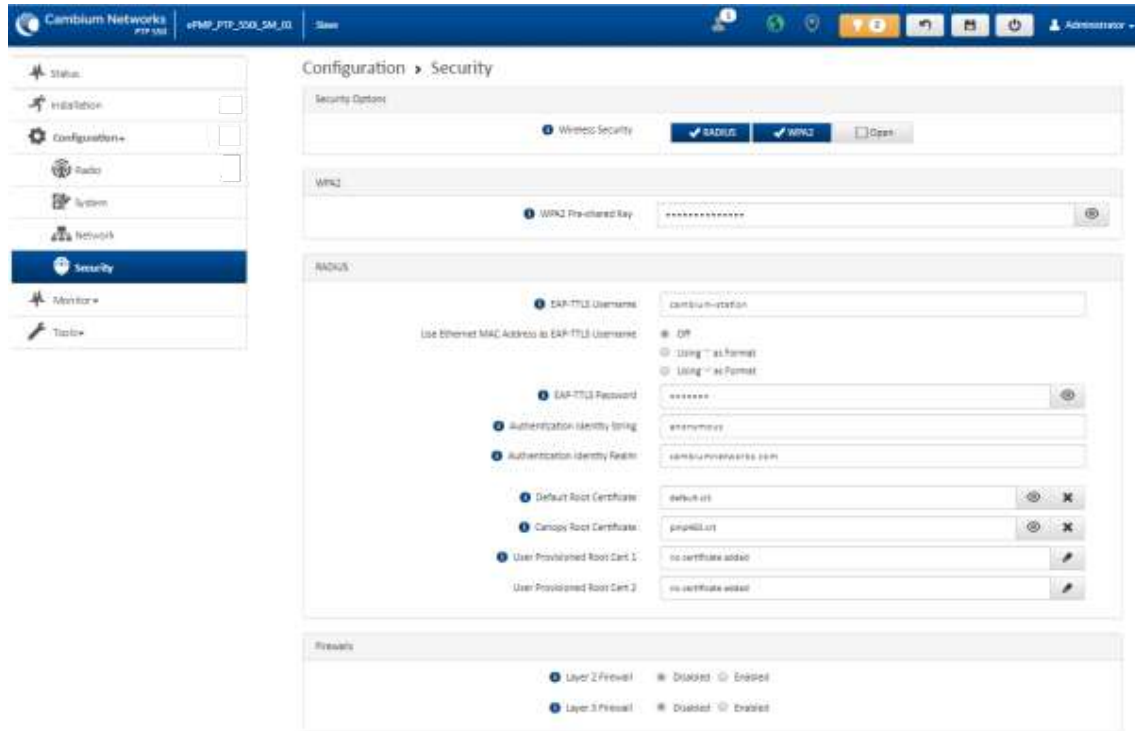

**Table 41** Configuration > Security page attributes

Attribute	Meaning
<b>Security Options</b>	
Wireless Security	<p>For Master mode devices, select the security mode enforced upon network entry.</p> <p>For Slave mode devices, select the security mode utilized upon network entry attempts.</p> <p><b>Open:</b> Slave devices attempting network entry are not subject to security mechanisms.</p> <p><b>WPA2:</b> The WPA2 mechanism provides AES radio link encryption and Slave network entry authentication. When enabled, the Slave must register using the Authentication Pre-shared Key configured on the Master and Slave.</p> <p><b>RADIUS:</b> Enables the connection to a pre-configured RADIUS server.</p>
<b>WPA2</b>	
WPA2 Pre-shared Key	Configure this key on the Master, then configure the Slave with this key to complete the authentication configuration. This key must be between 8 to 128 symbols.
<b>RADIUS</b>	
Servers	For more Radio servers, click <b>Add</b> . Up to 3 Radius servers can be configured on the device with the following attributes:

Attribute	Meaning
	<p><b>IP Address:</b> IP Address of the Radius server on the network.</p> <p><b>Port:</b> The Radius server port. Default is 1812.</p> <p><b>Secret:</b> Secret key that is used to communicate with the Radius server.</p>
Server Retries	Number of times the radio will retry authentication with the configured Radius server before it fails authentication of the Slave.
Server Timeout	Timeout between each retry with the configured Radius server before it fails authentication of the Slave.
GUI User Authentication	<p>This applies to both the Master and its registered Slave.</p> <p><b>Device Local Only:</b> The device's GUI authentication is local to the device using one of the accounts configured under <b>Configuration-&gt;System-&gt;Account Management</b>.</p> <p><b>Remote RADIUS Server Only:</b> The device's GUI authentication is performed using a RADIUS server.</p> <p><b>Remote RADIUS Server and Fallback to Local:</b> The device's GUI authentication is performed using a RADIUS server. Upon failure of authentication through a RADIUS server, the authentication falls back to one of the local accounts configured under <b>Configuration-&gt;System-&gt;Account Management</b>.</p>
EAP-TTLS Username (Slave mode only)	Configure the EAP-TTLS Username to match the credentials on the RADIUS server being used for the network.
Use Ethernet MAC Address as EAP-TTLS Username (Slave mode only)	The device MAC Address can be used as the EAP-TTLS Username in either ":" or "-" delimited format.
EAP-TTLS Password (Slave mode only)	Configure the EAP-TTLS Password to match the credentials on the RADIUS server being used for the network.
Authentication Identity String (Slave mode only)	Configure this Identity string to match the credentials on the RADIUS server being used for the network. Default value for this parameter is "anonymous".
Authentication Identity Realm (Slave mode only)	Configure this Identity string to match the credentials on the RADIUS server being used for the network. Default value for this parameter is "cambiumnetworks.com".
Default Root Certificate (Slave mode only)	Default EAP-TTLS root certificate that must match the certificate on the RADIUS server.
Canopy Root Certificate (Slave mode only)	PMP 450 default EAP-TTLS root certificate to match the certificate on the RADIUS server used with current PMP 450 installations.
User Provisioned Root Cert 1 (Slave mode only)	Import a user certificate if a certificate different from the default certificates is needed.

Attribute	Meaning
User Provisioned Root Cert 2 (Slave mode only)	Import a second user certificate if a certificate different from the default or 1 <sup>st</sup> user provisioned certificate is needed.
<b>Firewalls</b>	
Layer 2 Firewall	<b>Enabled:</b> Modifications to the Layer 2 Firewall Table are allowed and rules are enforced. <b>Disabled:</b> Modifications to the Layer 2 Firewall Table are not allowed and rules are not enforced.
Layer 2 Firewall Rules	The Layer 2 firewall table may be used to configure rules matching layer 2 (MAC layer) traffic which result in forwarding or dropping the traffic over the radio link or Ethernet/SFP interface.
Layer 3 Firewall	<b>Disabled:</b> Modifications to the Layer 3 Firewall Table are not allowed and rules are not enforced. <b>Enabled:</b> Modifications to the Layer 3 Firewall Table are allowed and rules are enforced.
Layer 3 Firewall Rules	The Layer 3 firewall table may be used to configure rules matching layer 3 (IP layer) traffic which result in forwarding or dropping the traffic over the radio link or Ethernet/SFP interface.

## Monitor menu

Use the **Monitor** menu to access device and network statistics and status information. This section may be used to analyze and troubleshoot network performance and operation.

## Monitor > Performance page

Figure 29 Monitor > Performance page

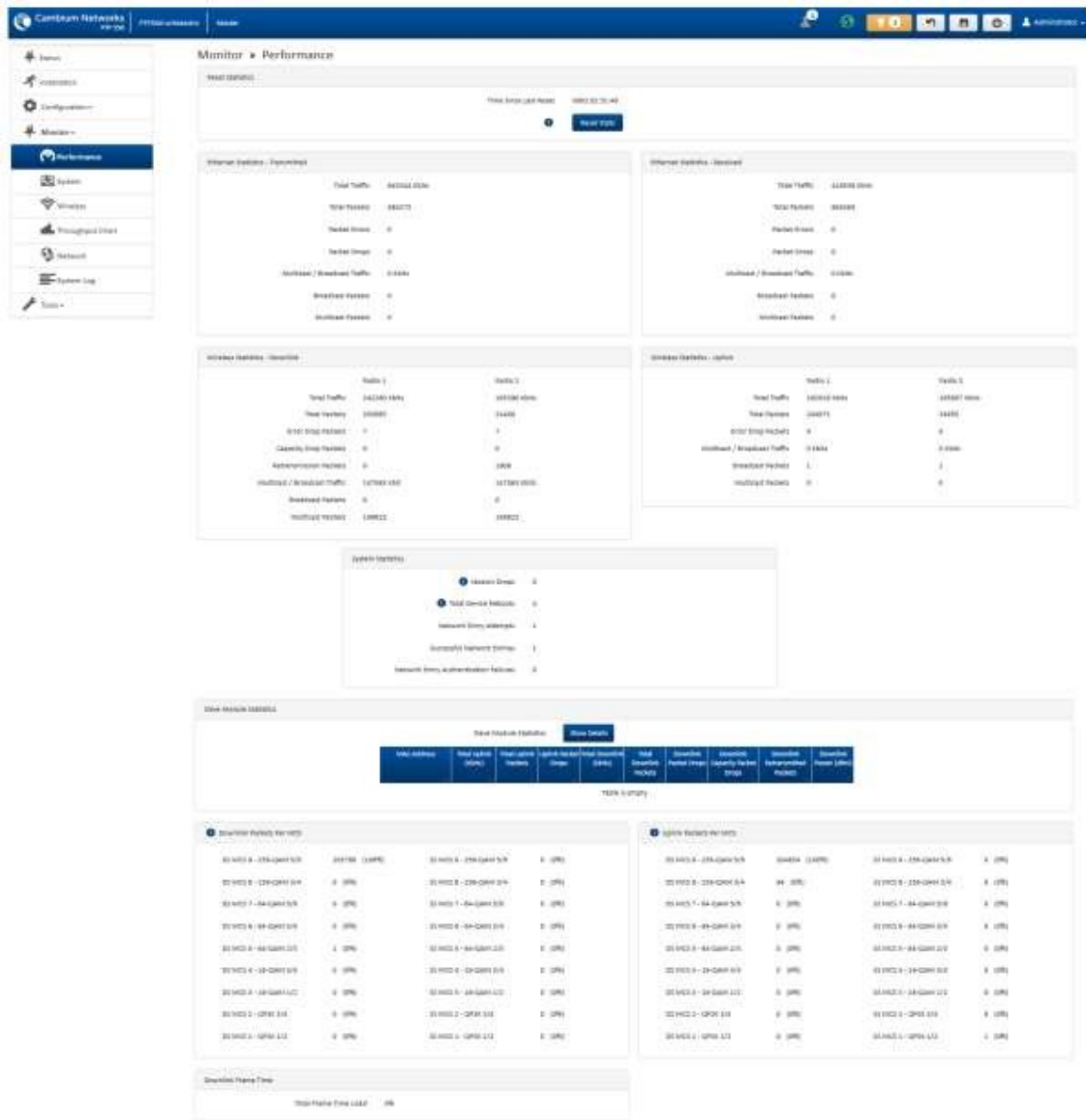

Table 42 Monitor > Performance page attributes

Attribute	Meaning
<b>Reset Statistics</b>	
Time Since Last Reset	Time since the stats were last reset.
<b>Ethernet Statistics – Transmitted</b>	
<i>Does not apply to SFP interface</i>	
Total Traffic	Total amount of traffic in Kbits transferred from the device Ethernet interface.

Attribute	Meaning
Total Packets	Total number of packets transferred from the device Ethernet interface.
Packet Errors	Total number of packets transmitted out of the device Ethernet interface with errors due to collisions, CRC errors, or irregular packet size.
Packet Drops	Total number of packets dropped prior to sending out of the device Ethernet interface due to Ethernet setup or filtering issues.
Multicast / Broadcast Traffic	Total amount of multicast and broadcast traffic in Kbits sent via the device Ethernet interface.
Broadcast Packets	Total number of broadcast packets sent via the device Ethernet interface.
Multicast Packets	Total number of multicast packets sent via the device Ethernet interface.
<b>Ethernet Statistics – Received</b>	
<i>Does not apply to SFP interface</i>	
Total Traffic	Total amount of traffic in Kbits received by the device Ethernet interface.
Total Packets	Total number of packets received by the device Ethernet interface.
Packet Errors	Total number of packets received by the device Ethernet interface with errors due to collisions, CRC errors, or irregular packet size.
Packet Drops	Total number of packets dropped prior to sending out of the device wireless interface due to Ethernet setup or filtering issues.
Multicast / Broadcast Traffic	Total amount of multicast and broadcast traffic in Kbits received by the device Ethernet interface.
Broadcast Packets	Total number of broadcast packets received via the device Ethernet interface.
Multicast Packets	Total number of multicast packets received via the device Ethernet interface.
<b>Wireless Statistics – Downlink</b>	
Total Traffic	Total amount of traffic transmitted out of the device wireless interface in Kbits.
Total Packets	Total number of packets transmitted out of the device wireless interface.
Error Drop Packets	Total number of packets dropped after transmitting out of the device Wireless interface due to RF errors (No acknowledgement and other RF related packet error).
Capacity Drop Packets (Master Mode Only)	Total number of packets dropped after transmitting out of the device Wireless interface due to capacity issues (data buffer/queue overflow or other performance or internal packet errors).
Retransmission Packets (Master Mode Only)	Total number of packets re-transmitted after transmitting out of the device Wireless interface due to the packets not being received by the Slave device.
Multicast / Broadcast Traffic	Total amount of multicast and broadcast traffic transmitted out of the device wireless interface in Kbits.
Broadcast Packets	Total number of broadcast packets transmitted out of the device wireless interface.
Multicast Packets	Total number of multicast packets transmitted out of the device wireless interface.

Attribute	Meaning
<b>Wireless Statistics – Uplink</b>	
Total Traffic	Total amount of traffic received via the device wireless interface in Kbits.
Total Packets	Total number of packets received via the device wireless interface.
Error Drop Packets	Total number of packets dropped prior to sending out of the device Ethernet interface due to RF errors (packet integrity error and other RF related packet error).
Capacity Drop Packets (Slave Mode Only)	Total number of packets dropped after transmitting out of the device Wireless interface due to capacity issues (data buffer/queue overflow or other performance or internal packet errors).
Retransmission Packets (Slave Mode Only)	Total number of packets re-transmitted after transmitting out of the device Wireless interface due to the packets not being received by the Slave device.
Multicast / Broadcast Traffic	Total amount of multicast and broadcast traffic received on the device wireless interface in Kbits.
Broadcast Packets	Total number of broadcast packets received on the device wireless interface.
Multicast Packets	Total number of multicast packets received on the device wireless interface.
Link Quality (Uplink) (Slave Mode only)	<p>Defines the Packet Error Rate (PER) in the uplink direction by percentage. A background color corresponds to a percentage range.</p> <p>Blue is between 80 and 100%.</p> <p>Green is between 50 and 80%.</p> <p>Yellow is between 30 and 50%.</p> <p>Red is between 0 and 30%.</p>
Link Capacity (Uplink) (Slave Mode only)	<p>Defines the capacity of the uplink as defined by MCS. DS MCS 9 provides the greatest capacity. SS MCS 1 provides the least. Capacity of the link is defined as the percentage throughput of the actual link as compared to a link that was always running at DS MCS 9. A background color corresponds to a percentage range.</p> <p>Blue is between 80 and 100%.</p> <p>Green is between 50 and 80%.</p> <p>Yellow is between 30 and 50%.</p> <p>Red is between 0 and 30%.</p>
<b>System Statistics</b>	
Session Drops	Indicates the number of times the Slave has disassociated with the Master since it was last reset. A link with many session drops indicates that something is causing the connection to be unstable.
Device Reboots	Indicates the number of times the device has rebooted since the statistics were last reset from the GUI, CLI, or SNMP.
Network Entry Attempts (Master Mode only)	Total number of Network Entry Attempts by Slave devices.

Attribute	Meaning
Successful Network Entries (Master Mode only)	Total number of successful network entry attempts.
Network Entry Authentication Failures (Master Mode only)	Total number of failed Network Entry Attempts by Slave devices.
<b>Slave Module Statistics</b>	
MAC Address	MAC Address of the Slave connected to the Master.
Total Uplink (Kbits)	Total amount of traffic received via the Master wireless interface from the Slave in Kbits.
Total Uplink Packets	Total number of packets received via the Master wireless interface from this Slave.
Uplink Packet Drops	Total number of packets dropped prior to sending out of the Master Ethernet interface due to RF errors (packet integrity error and other RF related packet error) from the Slave.
Total Downlink (Kbits)	Total amount of traffic transmitted out of the Master wireless interface in Kbits.
Total Downlink Packets	Total number of packets transmitted out of the Master wireless interface.
Downlink Packet Drops	Total number of packets dropped after transmitting out of the Master Wireless interface due to RF errors (No acknowledgement and other RF related packet error).
Downlink Capacity Packet Drops	Total number of packets dropped after transmitting out of the Master Wireless interface due to capacity issues (data buffer/queue overflow or other performance or internal packet errors).
Downlink Retransmitted Packets	Total number of packets re-transmitted after transmitting out of the Master Wireless interface due to the packets not being received by the Slave.
Downlink Power (dBm)	The transmit power of the Master for the downlink packets to the Slave.
<b>Downlink Packets Per MCS</b>	
MCS 1 – MCS 9 DS / SS	<p>Number of packets (and percentage of total packets) transmitted out of the device wireless interface for every modulation mode used by the device transmitter, based on radio conditions.</p> <p>DS represents dual-stream transmissions and SS represents single-stream transmissions.</p>
<b>Uplink Packets Per MCS</b>	
MCS 1 – MCS 9 DS / SS	<p>Number of packets (and percentage of total packets) received on the device wireless interface for every modulation mode, based on radio conditions.</p> <p>DS represents dual-stream transmissions and SS represents single-stream transmissions.</p>



Attribute	Meaning
<b>Downlink Frame Time</b>	
Total Frame Time Used	Percentage of frame time used in the uplink.
(Master Mode only)	

## Monitor > System page

Figure 30 Monitor > System page

The screenshot displays the 'Monitor > System' page in the Camblum Networks PTP550 web interface. The left sidebar contains navigation options: Status, Installation, Configuration, Monitor, Performance, System (selected), Wireless, Throughput Chart, Network, System Log, and Tools. The main content area shows the following system attributes:

Attribute	Value
Hardware Version	5 Dito PTP 550 Integrated Radio
Unit MSN	54T00046143
Firmware Version	U-Boot 2012.07 (PQ865) 4.1.0-RC1 (Jan 18 2018) 11:25:31
Software Version	4.1-RC1
Software Version (Active Bank)	4.1-RC1
Software Version (Inactive Bank)	4.0.1-RC3
Device-Agent Version	2.08
Date and Time	23 Jan 2018, 13:40:38 GMT
System Uptime	4 days, 23 hours, 42 minutes, 46 seconds
Wireless MAC Address	00:04:58:28:06:51
Ethernet MAC Address	00:04:58:28:06:4F
SIP Port MAC Address	00:04:58:28:06:50
Certificates FCI (Dial)	2848979038
Read-Only Users	0
Read-Write Users	1
GUI User Authentication	—
Factory Reset Via Power Sequence	Disabled
cnMaestro Core object Status	Connecting
cnMaestro Account ID	—

Table 43 Monitor > System page attributes

Attribute	Meaning
Hardware Version	Board hardware version information.
Unit MSN	Serial Number information.
Firmware Version	U-Boot version information.
Software Version	The currently operating version of software on the device.
Software Version (Active Bank)	The currently operating version of software on the device.
Software Version (Inactive Bank)	The backup software version on the device, used upon failure of the active bank. Two software upgrades in sequence will update both the <b>Active Software Bank Version</b> and the <b>Inactive Software Bank Version</b> .
Device-Agent Version	The operating version of the device agent, which is used for communication with cnMaestro.
Date and Time	Current date and time, subject to time zone offsets introduced by the configuration of the device <b>Time Zone</b> parameter. Until a valid NTP server is configured, this field will display the time configured from the factory.

Attribute	Meaning
System Uptime	The total system uptime since the last device reset.
Wireless MAC Address	The hardware address of the device wireless interface.
Ethernet MAC Address	The hardware address of the device LAN (Ethernet) interface.
SFP Port MAC Address	The hardware address of the device LAN (SFP) interface.
Contains FCC ID(s)	The device FCC ID.
Read-Only Users	Displays the number of active Read-Only users logged into the radio.
Read-Write Users	Displays the number of active Read-Write users logged into the radio.
GUI User Authentication	Indicates the method by which the user has been authenticated to access the device web management interface (GUI).
Factory Reset Via Power Sequence	<p><b>Enabled:</b> When Enabled under <b>Tools-&gt;Backup/Restore-&gt;Reset Via Power Sequence</b>, it is possible to reset the radio's configuration to factory defaults using the power cycle sequence explained under <a href="#">Resetting ODU to factory defaults by power cycling</a> on page 7-69.</p> <p><b>Disabled:</b> When Disabled, it is not possible to factory default the radio's configuration using the power cycle sequence.</p>
cnMaestro Connection Status	The current management status of the device with respect to the Cambium Cloud Server. When Enabled under <b>Configuration-&gt;System</b> , the device will be managed by the Cambium Remote Management System, which allows all Cambium devices to be managed from the Cambium Cloud Server.
cnMaestro Account ID	The ID that the device is currently using to be managed by the Cambium Cloud Server.

## Monitor > Wireless Page

Figure 31 Monitor > Wireless page (Master Mode)

The screenshot shows the 'Monitor > Wireless' page in Master Mode. The left sidebar contains navigation options: Status, Installation, Configuration, Monitor, Performance, System, **Wireless**, Throughput Chart, Network, System Log, and Tools. The main content area displays the following information:

- Radio 1** and **Radio 2** status: Wireless status is 'Up' for both.
- Operating frequency: 8640 MHz (Radio 1) and 8600 MHz (Radio 2).
- Operating channel bandwidth: 20 MHz (Radio 1) and 20 MHz (Radio 2).
- Transmit Power: 28 dBm (Radio 1) and 28 dBm (Radio 2).
- Registered Slave Modules: 0.
- Max PSU Port: 2000 Mbps / Full.
- Country: Other.

A table titled 'Registered Slave Modules' is shown below, with a 'Show Details' button. The table has the following data:

	MAC Address	System Time (hh:mm:ss)	RSSI (dBm) Uplink	SNR (dB) Uplink	MCS Downlink / Uplink	Connection Interface
Unregistered	00:04:50:20:00:78	1 days 02:55:20	-50	28	03 M/05 B	Radio 1
Registered	00:04:50:20:00:78	2 days 02:55:25	-66	28	03 M/05 B	Radio 2

Figure 32 Monitor > Wireless page (Slave Mode)

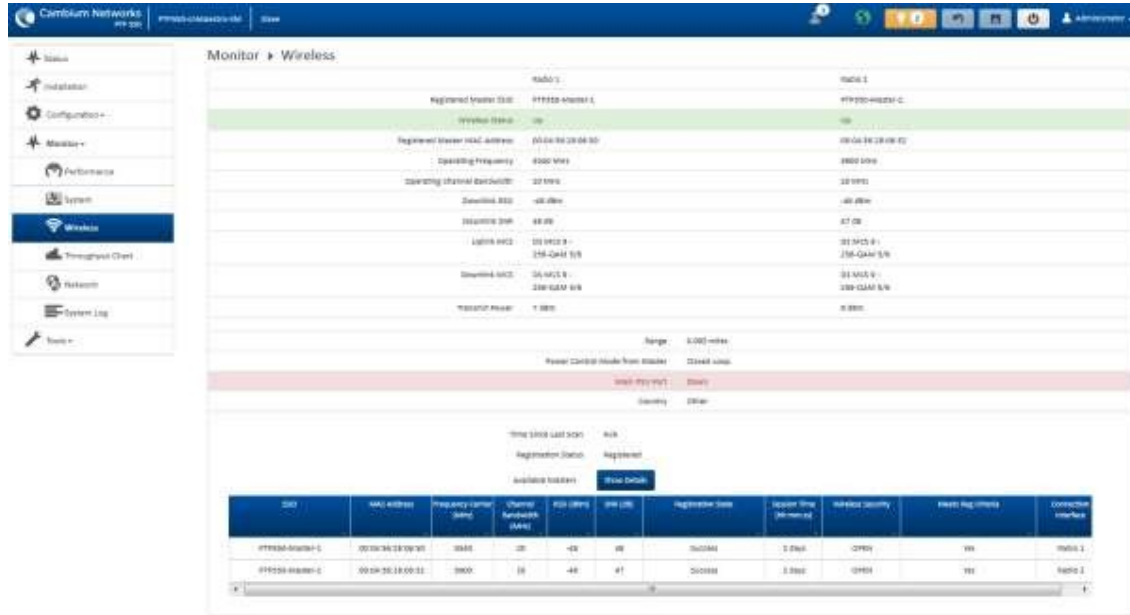



Table 44 Monitor > Wireless page attributes

Attribute	Meaning
Registered Master SSID (Slave Mode only)	SSID of the Master to which the Slave is registered.
Wireless Status (Master Mode)	<b>Up:</b> The device wireless interface is functioning and sending beacons. <b>Down:</b> The device wireless interface has encountered an error disallowing full operation. Reset the device to reinitiate the wireless interface.
Wireless Status (Slave Mode)	<b>Up:</b> The device wireless interface is functioning and the device has completed network entry. <b>Down:</b> The device wireless interface has encountered an error disallowing full operation. Evaluate radio and security configuration on the Master and Slave device to determine the network entry failure.
Registered Master MAC Address (Slave Mode only)	Wireless MAC address of the Master to which the Slave is registered.
Range (Slave Mode only)	The calculated distance from the Master, determined by radio signal propagation delay.
Operating Frequency	The current frequency at which the device is operating.
Operating Channel Bandwidth	The current channel size at which the device is transmitting and receiving.
Downlink RSSI (Slave Mode only)	The level of signal being received from the Master.

Attribute	Meaning
Downlink SNR (Slave Mode only)	The Signal-to-Noise Ratio of the signal being received from the Master.
Uplink MCS (Slave Mode only)	Specifies the current MCS utilized for uplink transmission.
Downlink MCS (Slave Mode only)	Specifies the current MCS utilized for downlink transmission.
Transmit Power	The current power level at which the device is transmitting.
Range	Indicates the calculated distance between the Master and Slave.
Power Control Mode from Master	<p><b>Open Loop:</b> In this mode, the Slave will not receive any power change information in the Group Poll Frame. The Slave calculates the uplink transmit power based on path loss calculations only.</p> <p><b>Closed Loop:</b> In closed loop uplink power control, the Slave will get the Master actual transmit power of beacon frame and <b>Slave Target Receive Power Level</b> in the beacon. Based on these two values, Slave calculates the path loss. Based on path loss and target receive level values it calculates the transmit power such that the signal from Slave arrives at Master at the configured target level. Path loss calculation will be updated by the Slave every time there is a change in values of Master actual transmit power or transmit receive level in the beacon.</p>
Registered Slave Modules (Master Mode only)	The count of registered Slave modules.
Main PSU Port	The speed and duplex at which the configured LAN port is operating.
Wireless Status (Master Mode)	<p><b>Up:</b> The device wireless interface is functioning and sending beacons.</p> <p><b>Down:</b> The device wireless interface has encountered an error disallowing full operation. Reset the device to reinitiate the wireless interface.</p>
Wireless Status (Slave Mode)	<p><b>Up:</b> The device wireless interface is functioning and the device has completed network entry.</p> <p><b>Down:</b> The device wireless interface has encountered an error disallowing full operation. Evaluate radio and security configuration on the Master and Slave device to determine the network entry failure.</p>
Country	Defines the country code being used by the device. The country code of the Slave follows the country code of the associated BHM, unless it is an FCC SKU in which case the country code is United States or Canada. Country code defines the regulatory rules in use for the device.
Registered Slave Modules (Master Mode only)	<p>Use the <b>Registered Slave Modules</b> table to monitor the registered Slave device, their key RF status and statistics information.</p> <p>Click the <b>Deregister</b> button to disassociate the Slave device from the Master.</p>
MAC Address	The MAC address of the Slave wireless interface.

Attribute	Meaning
(Master Mode only)	
Session Time (hh:mm:ss) (Master Mode only)	Time duration for which the Slave has been registered and in session with the Master.
MCS Downlink (Master Mode only)	Current MCS at which the Slave is operating on the downlink.
Add As Preferred (Slave Mode only)	Click the <b>Add</b>  button to add the Master to the <b>Preferred Masters List</b> under <b>Configuration&gt;Radio</b> .
SSID (Slave Mode only)	The SSID of the visible Master.
MAC Address (Slave Mode only)	The MAC address of the visible Master.
Frequency Carrier (MHz) (Slave Mode only)	The current operating frequency of the visible Master.
Channel Bandwidth (MHz) (Slave Mode only)	The current operating channel bandwidth of the visible Master.
RSSI (dBm) (Slave Mode only)	The current measured Received Signal Strength Indicator at the Master.
SNR (dB) (Slave Mode only)	The current measured Signal-to-Noise Ratio of the Slave to Master link.
Registration State (Slave Mode only)	The indication of the result of the Slave device network entry attempt: <b>Successful:</b> Slave registration is successful <b>Failed: Out of Range:</b> The Slave is out of the Master's configured maximum range ( <b>Max Range</b> parameter) <b>Failed: Capacity limit reached at Master:</b> The Master is no longer allowing Slave network entry due to capacity reached <b>Failed: No Allocation on Master:</b> The Slave to Master handshaking failed due to a misconfigured pre-shared key between the Slave and Master <b>Failed: SW Version Incompatibility:</b> The version of software resident on the Master is older than the software version on the Slave <b>Failed: PTP Mode: ACL Policy:</b> The Master is configured with <b>PTP Access</b> set to <b>MAC Limited</b> and the Slave's MAC address is not configured in the Master's <b>PTP MAC Address</b> field <b>Failed: Other:</b> The Master does not have the required available memory to allow network entry
Session Time (hh:mm:ss)	This timer indicates the time elapsed since the Slave registered to the Master.

Attribute	Meaning
(Slave Mode only)	
Wireless Security (Slave Mode only)	This field indicates the security state of the Master to Slave link.
Meets Reg Criteria (Slave Mode only)	<b>Yes:</b> The scanned Master meets the Network Entry criteria defined by the internal Network Algorithm. <b>No:</b> The scanned Master does not meet the Network Entry criteria defined by the internal Network Algorithm.
Connection Interface	Indicates the radio interface (Radio 1 or Radio 2) for which connection information is displayed.

## Monitor > Throughput Chart page

Use the Throughput Chart page to reference a line chart visual representation of system throughput over time. The blue line indicates downlink throughput and the orange line indicates uplink throughput. The X-axis may be configured to display data over seconds, minutes, or hours, and the Y-axis is adjusted automatically based on average throughput. Hover over data points to display details.

**Figure 33** Monitor > Throughput Chart page

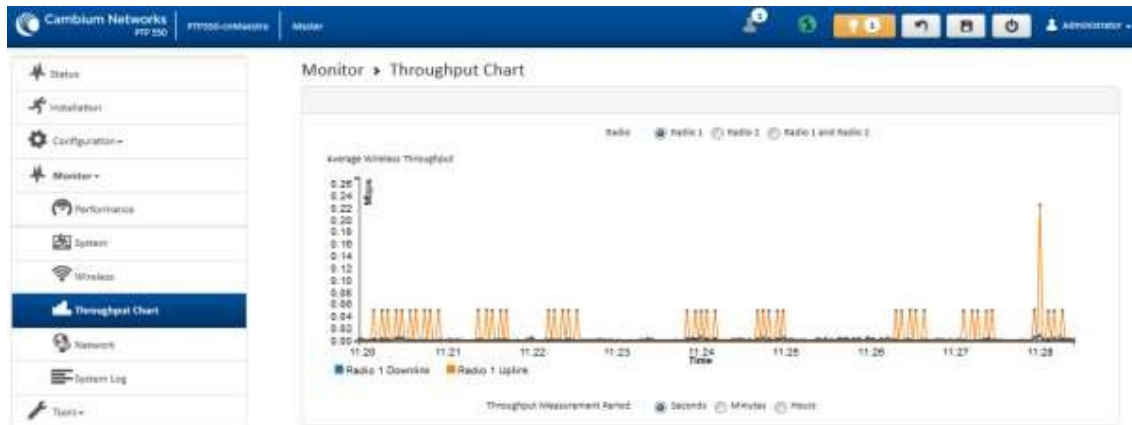

**Table 45** Monitor > Throughput Chart page attributes

Attribute	Meaning
Throughput Measurement Period	Adjust the X-axis to display throughput intervals in seconds, minutes, or hours

## Monitor > Network page

Use the Network Status page to reference key information about the device network status.

Figure 34 Monitor &gt; Network page

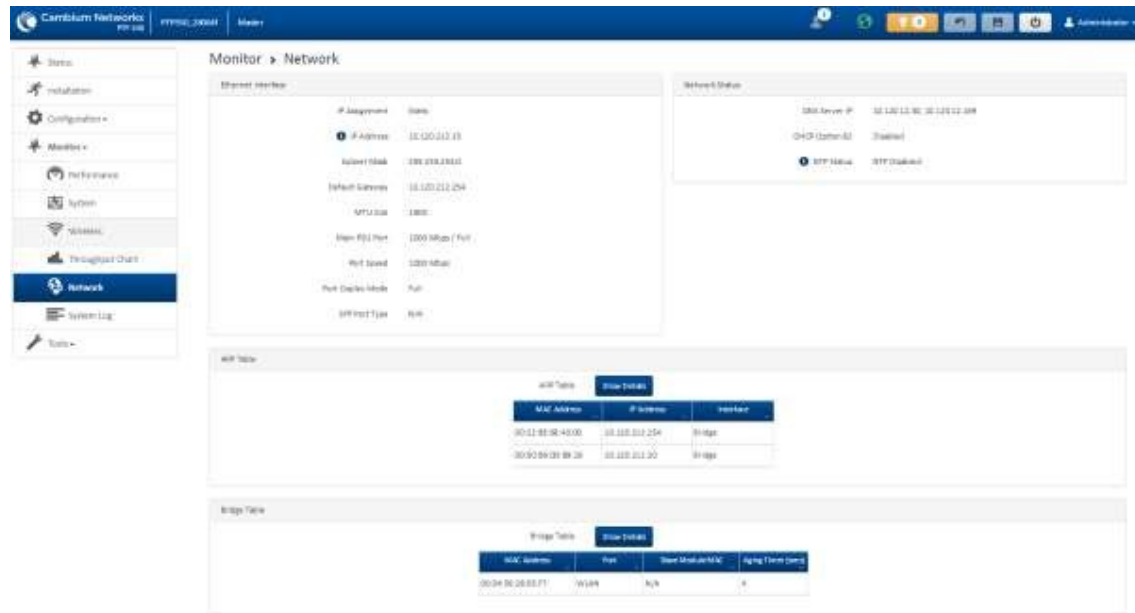



Table 46 Monitor &gt; Network page attributes

Attribute	Meaning
<b>Ethernet Interface</b>	
IP Assignment	<p><b>Static:</b> Device management IP addressing is configured manually in fields <b>IP Address</b>, <b>Subnet Mask</b>, <b>Gateway</b>, <b>Preferred DNS Server</b>, and <b>Alternate DNS Server</b>.</p> <p><b>DHCP:</b> Device management IP addressing (IP address, Subnet Mask, Gateway, and DNS Server) is assigned via a network DHCP server, and parameters <b>IP Address</b>, <b>Subnet Mask</b>, <b>Gateway</b>, <b>Preferred DNS Server</b>, and <b>Alternate DNS Server</b> are not configurable.</p>
IP Address	<p>Internet protocol (IP) address. This address is used by the family of Internet protocols to uniquely identify this unit on a network.</p> <p> <b>Note</b></p> <p>If <b>IP Address Assignment</b> is set to <b>DHCP</b> and the device is unable to retrieve IP address information via DHCP, the device management IP is set to fallback IP 169.254.1.1.</p>
Subnet Mask	<p>Defines the address range of the connected IP network. For example, if Device IP Address (LAN) is configured to 192.168.2.1 and IP Subnet Mask (LAN) is configured to 255.255.255.0, the device will belong to subnet 192.168.2.X.</p>
Default Gateway	<p>Configure the IP address of the device on the current network that acts as a gateway. A gateway acts as an entrance and exit to packets from and to other networks.</p>
MTU Size	<p>The currently configured Maximum Transmission Unit for the device Ethernet (LAN) interface. Larger MTU configurations can enable the network to operate with greater efficiency, but in the case of retransmissions due to packet errors, efficiency is reduced since large packets must be resent in the event of an error.</p>

Attribute	Meaning
Main PSU Port	The speed and duplex at which the configured LAN port is operating.
Port Speed	The speed at which the configured LAN port is operating.
Port Duplex Mode	The duplex at which the configured LAN port is operating.
SFP Port Type	Details of the SFP port connection.
<b>Network Status</b>	
Network Mode (Slave Mode only)	Indicates the mode of operation for the device on the network. <b>Bridge:</b> The Slave acts as a switch, and packets are forwarded or filtered based on their MAC destination address.
DNS Server IP	The configured IP address(es) of the network DNS servers.
DHCP Option 82 (Master Mode only)	Status of DHCP Option 82 operation in the network.
NTP Status	Represents the status of NTP retrieval in the network.
<b>ARP Table</b>	
MAC Address	MAC Address of the devices on the bridge.
IP Address	IP Address of the devices on the bridge.
Interface	Interface on which the PTP 550 identified the devices on.
<b>Bridge Table</b>	
MAC Address	The hardware address of devices on the network.
Port	The port to which the device is connected.
Slave Module MAC	MAC Address for the connected Slave device.
Aging Timer (secs)	Time set for the MAC addresses in the Bridge table before renewal.

## Monitor > System Log Page

Use the System Log page to view the device system log and to download the log file to the accessing PC/device.

Figure 35 Monitor > System Log page

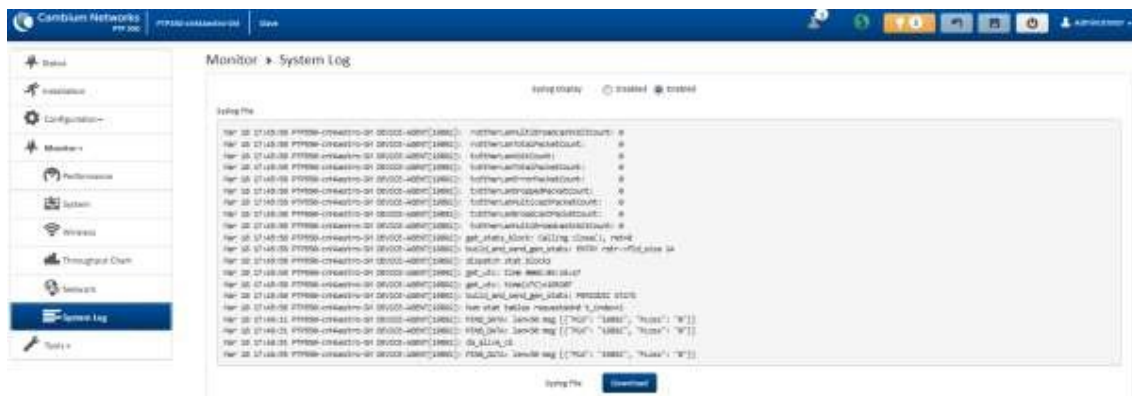



**Table 47** Monitor > System Log page attributes

Attribute	Meaning
Syslog Display	<b>Enabled:</b> The system log file is displayed on the management GUI. <b>Disabled:</b> The system log file is hidden on the management GUI.
Download	Use this button to download the full system log file to a connected PC or device.

## Tools menu

The **Tools** menu provides several options for upgrading device software, configuration backup/restore, analyzing RF spectrum, and analyzing interferers.

### Tools > Software Upgrade page

Use the **Software Upgrade** page to update the device radio software to take advantage of new software features and improvements.



#### Caution

Please read the Release Notes associated with each software release for special notices, feature updates, resolved software issues, and known software issues.

The Release Notes may be accessed at the [Cambium Support Center](#).

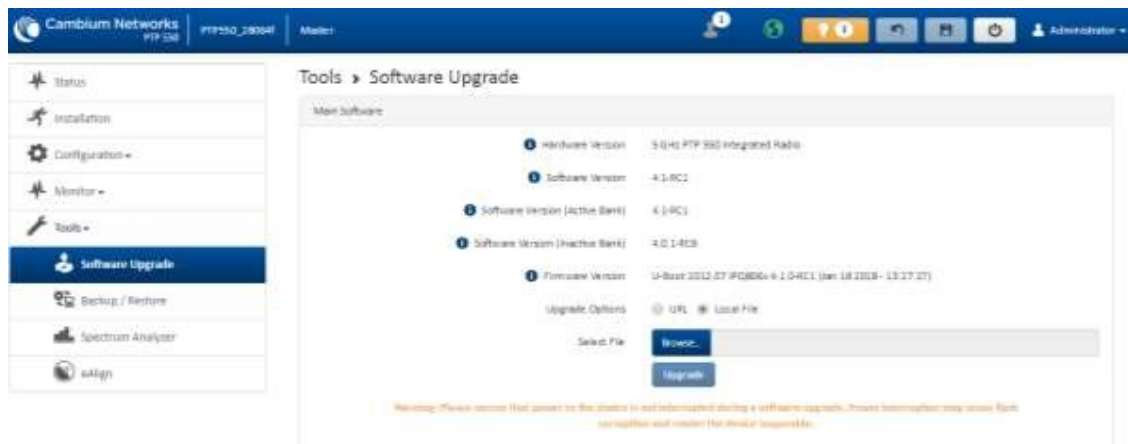
**Figure 36** Tools > Software Upgrade page**Table 48** Tools > Software Upgrade page attributes

Attribute	Meaning
<b>Main Software</b>	
Hardware Version	Defines the board type and frequency band of operation.
Software Version	Defines the current operating software version.

Attribute	Meaning
Software Version (Active Bank)	PTP 550 devices two banks of flash memory which each contain a version of software. The version of software last upgraded onto the Flash memory is made the Active Bank. This software will be used by the device when rebooted.
Software Version (Inactive Bank)	The version of software that was the Active Bank is made the Inactive Bank when another version of software is upgraded onto the Flash memory. The Inactive Bank of software will be used by the device in case the Active Bank cannot be used due to a failure condition.
Firmware Version	The current U-boot version.
Upgrade Options	<p><b>URL:</b> A webserver may be used to retrieve software upgrade packages (downloaded to the device via the webserver). For example, if a webserver is running at IP address 192.168.2.1 and the software upgrade packages are located in the home directory, an operator may select option <b>From URL</b> and configure the <b>Software Upgrade Source</b> field to <b>http://192.168.2.1/&lt;software_upgrade_package&gt;</b>.</p> <p><b>Local File:</b> Click Browse to select the local file containing the software upgrade package.</p>
Select File	Click <b>Browse</b> to select a local file (located on the device accessing the web management interface) for upgrading the device software.
Upgrade	<p>Click the <b>Upgrade</b> button to begin the software upgrade process.</p> <p> <b>Caution</b></p> <p>Please ensure that power to the device is not interrupted during a software upgrade. Power interruption may cause flash corruption and render the device inoperable.</p>



## Tools > Backup/Restore page

Use the **Backup/Restore** page to update the device radio software to take advantage of new software features and improvements.

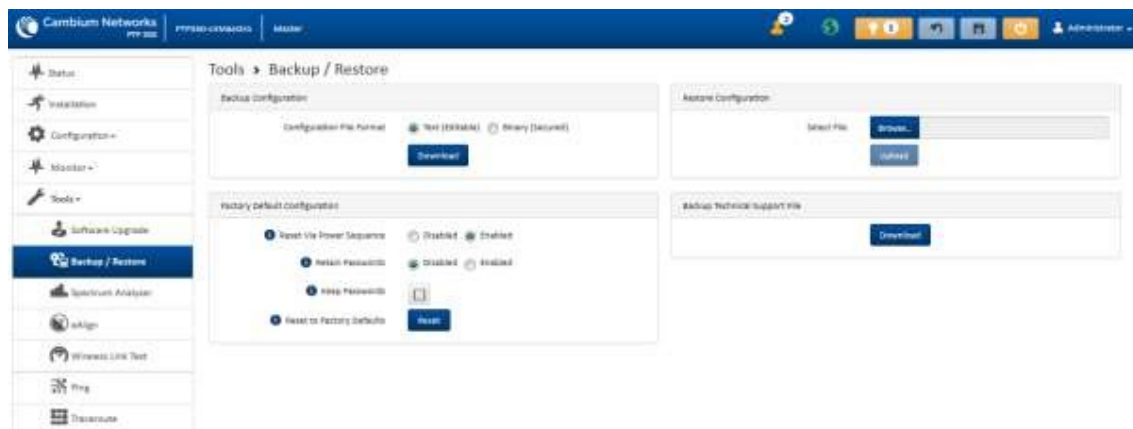
**Figure 37** Tools > Backup/Restore page



**Table 49** Tools > Backup/Restore page attributes

Attribute	Meaning
<b>Backup Configuration</b>	
Configuration File Format	<p><b>Text (Editable):</b> Choosing this option will download the configuration file in the .json format, and can be viewed and/or edited using a standard text editor.</p> <p><b>Binary (Secured):</b> Choosing this option will download the configuration file in the .bin format, and cannot be viewed and/or edited using an editor. Use this format for a secure backup.</p>
<b>Restore Configuration</b>	
Select File	Click <b>Browse</b> to select a local file (located on the device accessing the web management interface) for restoring the device configuration.
<b>Factory Default Configuration</b>	
Reset Via Power Sequence	<p><b>Enabled:</b> When Enabled, it is possible to reset the radio's configuration to factory defaults using the power cycle sequence explained under <a href="#">Resetting ODU to factory defaults by power cycling</a> on page 7-69.</p> <p><b>Disabled:</b> When Disabled, it is not possible to factory default the radio's configuration using the power cycle sequence.</p>
Retain Passwords	<p>When set to <b>Enabled</b>, then after a factory default of the radio for any reason, the passwords used for GUI and CLI access will not be defaulted and will remain unchanged. The default value of this field is <b>Disabled</b>.</p> <hr/> <p> Caution</p> <p>If the passwords cannot be retrieved after the factory default, access to the radio will be lost/unrecoverable. This feature prevents unauthorized users from gaining access to the radio for any reason, including theft.</p>
Keep Passwords	When the <b>Keep Passwords</b> checkbox is selected, the passwords used for GUI and CLI access will not be defaulted and will remain unchanged. This is one-time option, and it does not apply to factory default procedures completed by power cycling (Reset Via Power Sequence).
Reset to Factory Defaults	<p>Use this button to reset the device to its factory default configuration.</p> <hr/> <p> Caution</p> <p>A reset to factory default configuration resets all device parameters. With the Slave device in default configuration it may not be able to register to a Master device configured for your network.</p>
<b>Backup Technical Support File</b>	
Download	The Backup Technical Support File is a compressed archive of the applicable statistics and configuration parameters used by Cambium Support for troubleshooting. This file is downloaded from the PTP 550 device to the accessing device.

## Tools > Spectrum Analyzer page

Use the **Spectrum Analyzer** page to measure signal levels of frequencies across the full range of the device or in a custom range.

Figure 38 Tools &gt; Spectrum Analyzer page

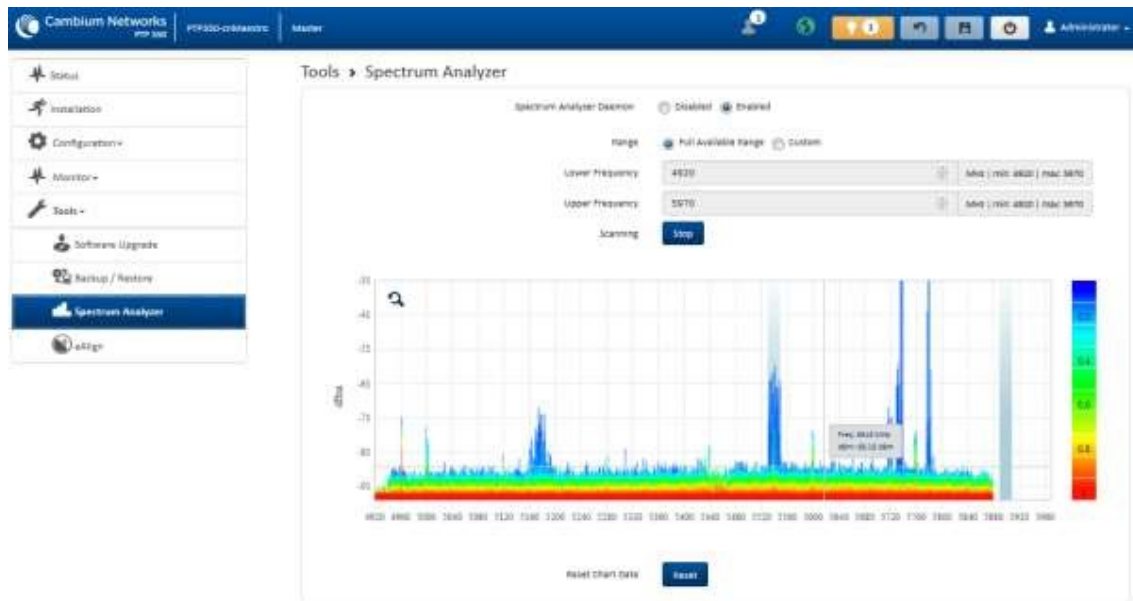

Table 50 Tools &gt; Spectrum Analyzer page attributes

Attribute	Meaning
Spectrum Analyzer Daemon	<b>Disabled:</b> The Spectrum Analyzer process is not running on the device. <b>Enabled:</b> The Spectrum Analyzer process is running on the device, necessary for displaying results in the web management interface.
Range	<b>Full Available:</b> The entire operating range of the device will be scanned. <b>Custom:</b> The device scans only the range defined by <b>Lower Frequency</b> and <b>Upper Frequency</b> .
Lower / Upper Frequency	When <b>Range</b> is configured to <b>Custom</b> , indicates the range in MHz for which the device will scan.
Scanning	Click <b>Start</b> to begin scanning, and <b>Stop</b> to terminate scanning.

## Tools > eAlign page

Use the eAlign page to aid with link alignment.

Figure 39 Tools &gt; eAlign page

**Note**

A valid link between the Master and Slave is required to provide meaningful RSSI measurements.

**Caution**

PTP 550 supports Automatic Transmit Power Control (ATPC) where the Slave devices are instructed by the Master to adjust their Tx power in order for the Slave device signal (UL RSSI) to arrive at the Master at a predetermined RSSI level (configurable on the Master under **Configuration>Radio>Power Control>Slave Module Target Receive Level**). This feature is beneficial to keep the overall noise floor in the sector to an acceptable level. However, the feature negates the purpose of eAlign measurements on the Master device since, during the alignment, the Slave may constantly change its Tx power. It is recommended to turn off ATPC and set the Slave Tx power to maximum allowable power during alignment.

While aligning the link using eAlign, please follow these steps:

**Procedure:**

- 1 On the Slave, set **Configuration>Radio>Power Control>Max Tx Power** to **Manual**.
- 2 Set **Configuration>Radio>Power Control>Transmitter Power** to **30 dBm** (or maximum value allowed by regulations).
- 3 Click the **Save** button
- 4 Perform link alignment using **eAlign**
- 5 Once alignment is complete, set **Configuration>Radio>Power Control>Max Tx Power** back to **Auto**
- 6 Click the **Save** button

## Tools > Wireless Link Test page

Use the Wireless Link Test page to conduct a simple test of wireless throughput. This allows user to determine the throughput that can be expected on a particular link without having to use external tools.

Figure 40 Tools > Wireless Link Test page

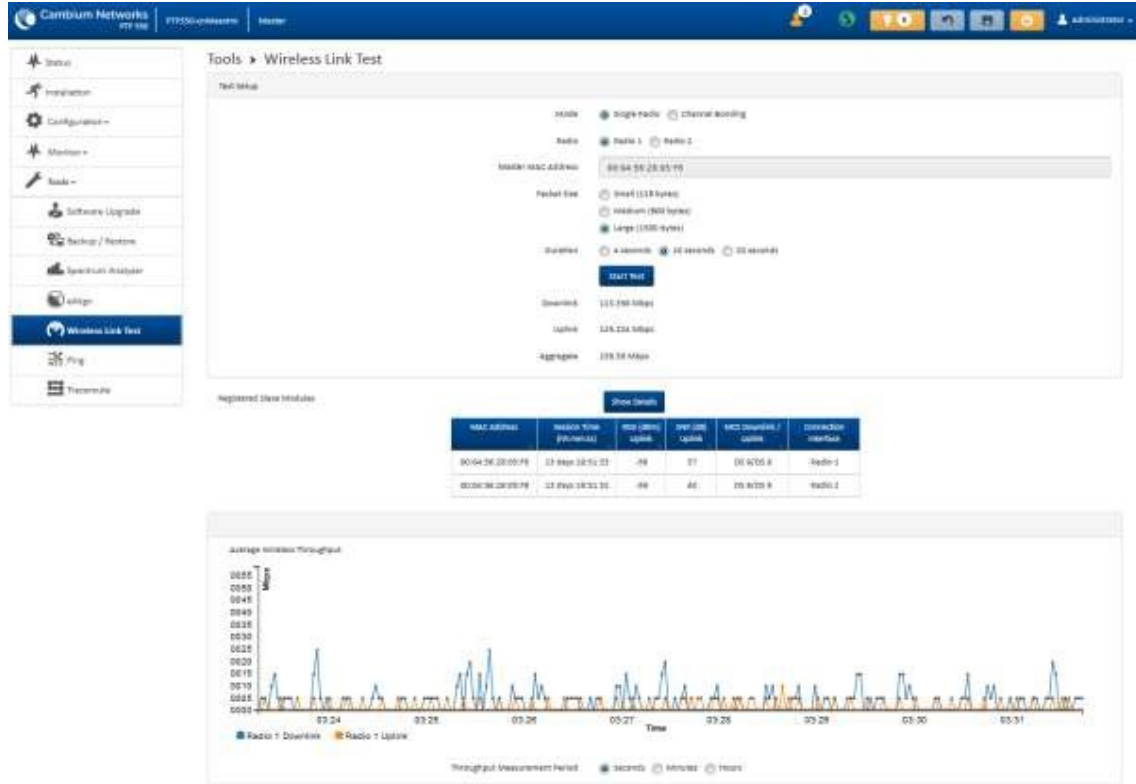

Table 51 Tools > Wireless Link Test page attributes

Attribute	Meaning
<b>Test Setup</b>	
Mode	<b>Single Radio:</b> One radio interface is used for the link test, specified in the <b>Radio</b> parameter <b>Channel Bonding:</b> The wireless link test is conducted with both radio interfaces
Radio	<b>Radio 1:</b> Radio 1 is utilized for the wireless link test <b>Radio 2:</b> Radio 2 is utilized for the wireless link test
Master MAC Address	Displays the MAC address of the registered device
Packet Size	Choose the Packet Size to use for the throughput test
Duration	Choose the time duration in seconds to use for the throughput test
Downlink	This field indicates the result of the throughput test on the downlink, in Mbps
Uplink	This field indicates the result of the throughput test on the uplink, in Mbps

Attribute	Meaning
Aggregate	This field indicates the total aggregate uplink and downlink capacity of the link, in Mbps
Registered Slave Modules	This table lists the connected radio interfaces for the slave device, as well as applicable RSSI, SNR, MCS statistics.
Average Wireless Throughput	Auto-adjusting chart displaying the average throughput of the link

## Tools > Ping page

Use the Ping page to conduct a simple test of IP connectivity to other devices which are reachable from the network. If no ping response is received or if “Destination Host Unreachable” is reported, the target may be down, there may be no route back to the device, or there may be a failure in the network hardware (i.e. DNS server failure).

**Figure 41** Tools > Ping page

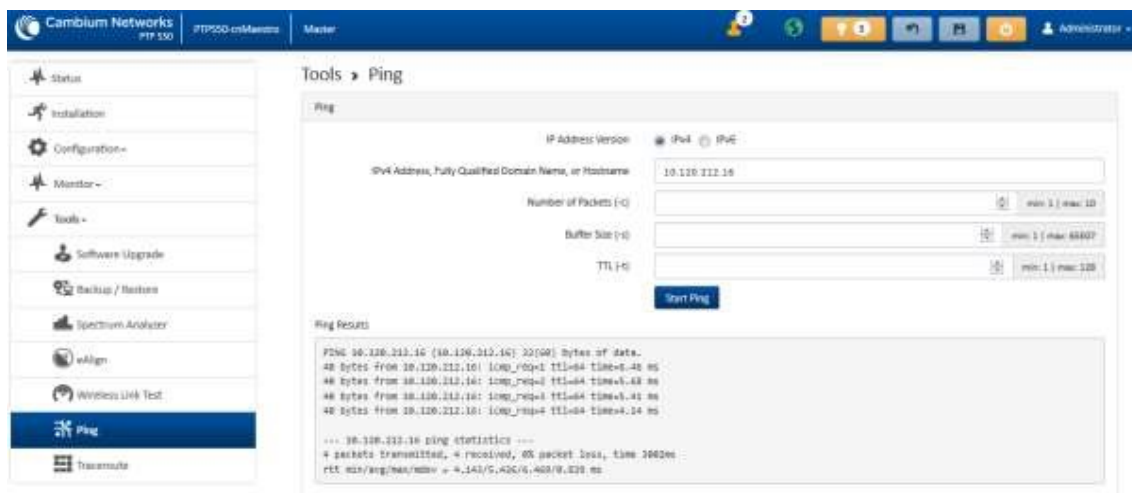

**Table 52** Tools > Ping page attributes

Attribute	Meaning
<b>Ping</b>	
IP Address Version	<b>IPv4:</b> The ping test is conducted via IPv4 protocol. <b>IPv6:</b> The ping test is conducted via IPv6 protocol.
IPv4 Address, Fully Qualified Domain Name, or Hostname	Enter the ping target IP address, FQDN, or Hostname.
Number of packets (-c)	Enter the total number of ping requests to send to the target.

Attribute	Meaning
Buffer size (-s)	Enter the number of data bytes to be sent.
TTL (-t)	Set the IP Time-To-Live (TTL) for multicast packets. This flag applies if the ping target is a multicast address.
Ping results	Results of the Ping test are displayed in the box.

## Tools > Traceroute page

Use the Traceroute page to display the route (path) and associated diagnostics for IP connectivity between the device and the destination specified.

**Figure 42** Tools > Traceroute page

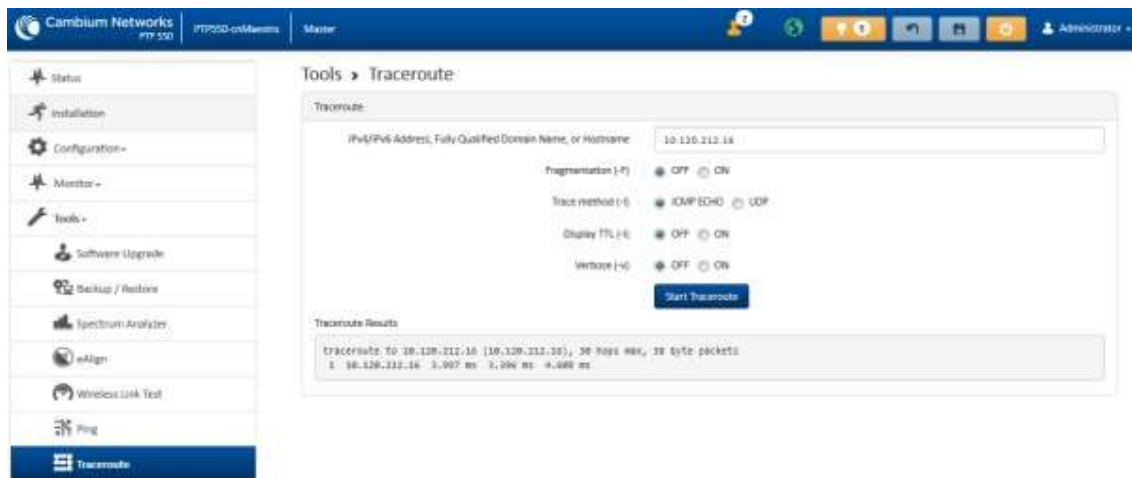

**Table 53** Tools > Traceroute page attributes

Attribute	Meaning
<b>Traceroute</b>	
IPv4 Address, Fully Qualified Domain Name, or Hostname	Enter the traceroute target IP address, FQDN, or Hostname.
Fragmentation (-F)	<b>ON:</b> Allow source and target to fragment probe packets. <b>OFF:</b> Do not fragment probe packets (on source or target).
Trace method (-l)	<b>ICMP ECHO:</b> Use ICMP ECHO for traceroute probes. <b>UDP:</b> Use UDP for traceroute probes.
Display TTL (-l)	<b>ON:</b> Display TTL values for each hop on the route. <b>OFF:</b> Suppress display of TTL values for each hop on the route.
Verbose (-v)	<b>ON:</b> ICMP packets other than TIME_EXCEEDED and UNREACHABLE are displayed in the output.



<b>Attribute</b>	<b>Meaning</b>
	OFF: Suppress display of extraneous ICMP messaging.
Traceroute Results	Traceroute test results are displayed in the box.

## Other configuration tasks

---

This section describes other configuration tasks.

### Connecting to the network

Use this procedure to complete and test network connections.

**Procedure:**

- 1 If a management PC is connected directly to the PTP 550, disconnect it.
- 2 Confirm that all ODU Ethernet interface cables (PSU, SFP) are connected to the correct network terminating equipment or devices.
- 3 Test that the unit is reachable from the network management system by opening the web interface to the management agent, or by requesting ICMP echo response packets using the Ping application. For in-band management, test that both units are reachable from one PC.  
If the network management system is remote from the sites, either ask co-workers at the management center to perform this test, or use remote login to the management system.
- 4 Test the data network for correct operation across the wireless link. This may be by requesting ICMP echo response packets between hosts in the connected network segments, or by some more structured use of network testing tools.
- 5 Monitor the Ethernet ports and wireless link to confirm that they are running normally.

---

# Chapter 7: Operation and Troubleshooting

---

This chapter provides instructions for operators of PTP 550 networks. The following topics are described:

- [General Planning for Troubleshooting](#) on page 7-61
- [Upgrading device software](#) on page 7-63
- [Testing hardware](#) on page 7-64
- [Troubleshooting the radio link](#) on page 7-67
- [Using the device external reset button](#) on page 7-68
- [Resetting ODU to factory defaults by power cycling](#) on page 7-69

# General Planning for Troubleshooting

---

Effective troubleshooting depends in part on measures that you take before you experience trouble in your network. Cambium recommends the following measures for each site:

**Procedure:**

- 1 Identify troubleshooting tools that are available at your site (such as a protocol analyzer).
- 2 Identify commands and other sources that can capture baseline data for the site. These may include:
  - Ping
  - tracert or traceroute
  - Throughput Test results
  - Throughput data
  - Configure GUI page captures
  - Monitor GUI page captures
  - Session logs
- 3 Start a log for the site, including:
  - Operating procedures
  - Site-specific configuration records
  - Network topology
  - Software releases
  - Types of hardware deployed
  - Site-specific troubleshooting process
  - Escalation procedures
  - GPS latitude/longitude of each network element

## General Fault Isolation Process

Effective troubleshooting also requires an effective fault isolation methodology that includes

- Attempting to isolate the problem to the level of a system, subsystem, or link, such as
  - Master to Slave
  - Master to CMM
  - CMM to GPS
  - power
- Researching System Logs of the involved equipment.
- Answering the questions listed in the following section.
- Reversing the last previous corrective attempt before proceeding to the next.
- Performing only one corrective attempt at a time.

## Questions to Help Isolate the Problem

When a problem occurs, attempt to answer the following questions:

- 1 What is the history of the problem?
  - Have we changed something recently?
  - Have we seen other symptoms before this?
- 2 How wide-spread is the symptom?
- 3 Based on data in the System Log
  - Is intermittent connectivity indicated? (If so, verify your configuration, power level, CINR, cables and connections, and the speed duplex of both ends of the link).
- 4 Are connections made via *shielded* cables?
- 5 Does the GPS antenna have an *unobstructed* view of the entire horizon?

# Upgrading device software

To take advantage of new features and software improvements for the PTP 550 system, monitor the Cambium Networks Software website:

<http://support.cambiumnetworks.com>

To upgrade the device software:

## Procedure:

- 1 Log in to the device GUI via the management IP
- 2 Navigate to page **Tools, Software Upgrade**

- 3 Under the **Main Software** section, set the **Upgrade Option** to **URL** to pull the software file from a network software server or select **Local File** to upload a file from the accessing device.  
If **URL** is selected, enter the server IP address, Server Port, and File path.

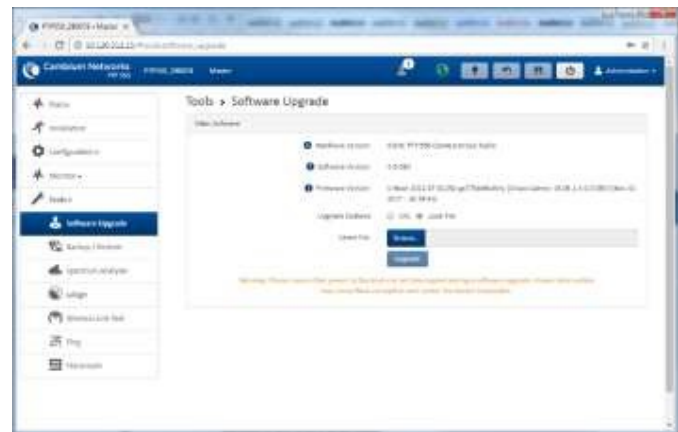

- 4 If **Local File** is selected, click **Browse** to launch the file selection dialogue
- 5 Click **Upgrade**



### Caution

Do not power off the unit in the middle of a software upgrade.

- 6 Once the software upgrade is complete, click the **Reset** icon.

# Testing hardware

---

This section describes how to test the hardware when it fails on startup or during operation.

Before testing hardware, confirm that all outdoor cables, that is those that connect the ODU to equipment inside the building, are of the supported type, as defined in [Ethernet cabling](#) on page 2-13

## Checking the power supply LED

When the power supply is connected to the main power supply, the expected LED behavior is:

- The Power (green) LED illuminates steadily.

If the expected LED operation does not occur, or if a fault is suspected in the hardware, check the LED states and choose the correct test procedure:

- [Power LED is off](#) on page 7-64
- [Ethernet LED is off](#) on page 7-64

## Power LED is off

**Meaning:** Either the power supply is not receiving power from the AC/DC outlet, or there is a wiring fault in the unit.

**Action:** Remove the Ethernet cable from the PSU and observe the effect on the Power LED. If the Power LED does not illuminate, confirm that the mains power supply is working, for example, check the plug. If the power supply is working, report a suspected power supply fault to Cambium Networks.

## Ethernet LED is off

**Meaning:** There is no Ethernet traffic between the device and power supply.

**Action:** The fault may be in the LAN or device cable:

- Remove the LAN cable from the power supply, examine it and confirm it is not faulty.
- If the PC connection is working, remove the device cable from the power supply, examine it, and check that the wiring to pins 1&2 and 3&6 is correct and not crossed.

## Test Ethernet packet errors reported by ODU

Log into the device and click **Monitor, Performance**. Click **Reset System Counters** at the bottom of the page and wait until **LAN RX – Total Packet Counter** has reached 1 million. If the counter does not increment or increments too slowly, because for example the system is newly installed and there is no offered Ethernet traffic, then abandon this procedure and consider using the procedure [Test ping packet loss](#) on page 7-65.

Check the **LAN RX – Error Packet Counter** statistic. The test has passed if this is less than 10.

## Test Ethernet packet errors reported by managed switch or router

If the device is connected to a managed Ethernet switch or router, it may be possible to monitor the error rate of Ethernet packets. Please refer to the user guide of the managed network equipment. The test has passed if the rate of packet errors reported by the managed Ethernet switch or router is less than 10 in 1 million packets.

## Test ping packet loss

Using a computer, it is possible to generate and monitor packets lost between the power supply and the device. This can be achieved by executing the Command Prompt application which is supplied as standard with Windows and Mac operating systems.



### Caution

This procedure disrupts network traffic carried by the AP or SM under test.

---

### Procedure:

1. Ensure that the IP address of the computer is configured appropriately for connection to the ODU under test, and does not conflict with other devices connected to the network.
2. If the power supply is connected to an Ethernet switch or router then connect the computer to a spare port, if available.
3. If it is not possible to connect the computer to a spare port of an Ethernet switch or router, then the power supply must be disconnected from the network in order to execute this test:
  - Disconnect the power supply from the network.
  - Connect the computer directly to the LAN port of the power supply.
4. On the computer, open the Command Prompt application.
5. Send 1000 ping packets of length 1500 bytes. The process will take 1000 seconds, which is approximately 17 minutes.

If the computer is running a Windows operating system, this is achieved by typing (for an IPv6 address, use the ping6 command):

```
ping -n 1000 -l 1500 <ipaddress>
```

where <ipaddress> is the IP address of the AP or SM under test.

If the computer is running a MAC operating system, this is achieved by typing:

```
ping -c 1000 -s 1492 <ipaddress>
```

where <ipaddress> is the IP address of the ODU under test.

6. Record how many Ping packets are lost. This is reported by Command Prompt on completion of the test.



The test has passed if the number of lost packets is less than 2.

# Troubleshooting the radio link

---

This section describes how to test the link when there is no radio communication, when it is unreliable, or when the data throughput rate is too low. It may be necessary to test ODUs at both ends of the link.

## Module has lost or does not establish radio connectivity

If there is no wireless activity, follow this:

**Procedure:**

- 1 Check that the ODUs are configured with the same **Frequency Carrier**.
- 2 Verify the authentication settings on the ODU. If **Authentication Type** is set to **WPA2**, verify that the **Pre-shared Key** matches between the ODUs.
- 3 Check that the software at each end of the link is the same version.
- 4 Check that the desired Master ODU SSID is configured in the Slave **Preferred Masters List**.
- 5 On the Slave ODU, check the **DL RSSI** and **DL CINR** values. Verify that for the ODU installed distance, that the values are consistent with the values reported by the LINKPlanner tool.
- 6 Check Tx Power on the ODUs
- 7 Check that the link is not obstructed or the ODUs misaligned.
- 8 If there are no faults found in the configuration and there is absolutely no wireless signal, retry the installation procedure.
- 9 If this does not work then report a suspected ODU fault to Cambium Networks.

## Link is unreliable or does not achieve data rates required

If there is some activity but the link is unreliable or does not achieve the data rates required, proceed as follows:

**Procedure:**

- 1 Check that the interference has not increased by monitoring the uplink and downlink CINR values reported in the ODU page **Monitor, Wireless Status**
- 2 Check that the RSSI values reported at the ODU are proper based on the distance of the link – the LINKPlanner tool is designed to estimate these values.
- 3 Check that the path loss is low enough for the communication rates required.
- 4 Check that the ODU has not become misaligned.
- 5 Review your Quality of Service configuration and ensure that traffic is properly classified and prioritized.

## Using the device external reset button

---

PTP 550 ODUs feature an external button which serves two purposes:

- To reset the device (briefly depress the button for more than two seconds but less than ten seconds then release)



**Caution**

If the reset button is pressed for more than ten seconds while powered on, the device will reset back to its factory default configuration

---

- To reset the device to its factory default configuration (depress the button for more than ten seconds then release)

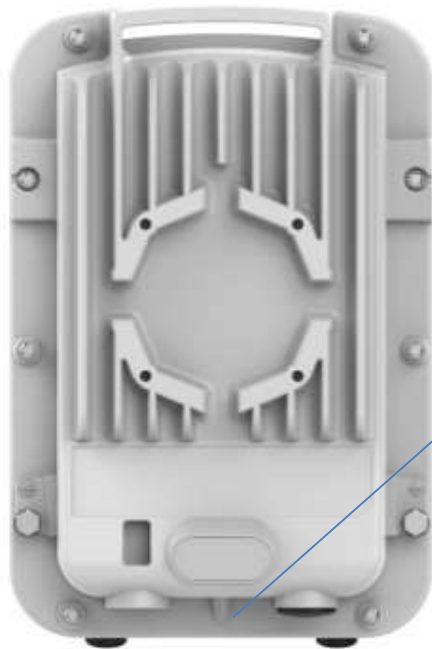

PTP 550 Reset Button

## Resetting ODU to factory defaults by power cycling

Operators may reset a PTP 550 radio to default factory configuration by a sequence of power cycling (removing and re-applying power to the device). This procedure allows operators to perform a factory default reset without a tower climb or additional tools. The procedure is depicted in Figure 53.

### Procedure:

- 1 Remove the Ethernet cable from PoE jack of the power supply for at least 10 seconds.
- 2 Reconnect the Ethernet cable to re-supply power to the ODU for **3-5 seconds** and disconnect cable to power off the ODU for **3-5 seconds**. (1<sup>st</sup> power cycle)
- 3 Reconnect the Ethernet cable to re-supply power to the ODU for **3-5 seconds** and disconnect cable to power off the ODU for **3-5 seconds**. (2<sup>nd</sup> power cycle)
- 4 Reconnect the Ethernet cable to re-supply power to the ODU for **3-5 seconds** and disconnect cable to power off the ODU for **3-5 seconds**. (3<sup>rd</sup> power cycle)
- 5 Reconnect the Ethernet cable to re-supply power to the ODU for **3-5 seconds** and disconnect cable to power off the ODU for **3-5 seconds**. (4<sup>th</sup> power cycle)
- 6 Reconnect the Ethernet cable to re-supply power to the ODU for at least **30 seconds** and allow it to go through the boot up procedure (Note: Device will go through an additional reset automatically). This will reset the current configuration files to factory default configuration (e.g. IP addresses, Device mode, RF configuration etc.). The device can be pinged from a PC to check if boot up is complete (Successful ping replies indicates boot up is complete).
- 7 Access the ODU e using the default IP address of 192.168.0.1.

**Figure 43** Power cycle timings

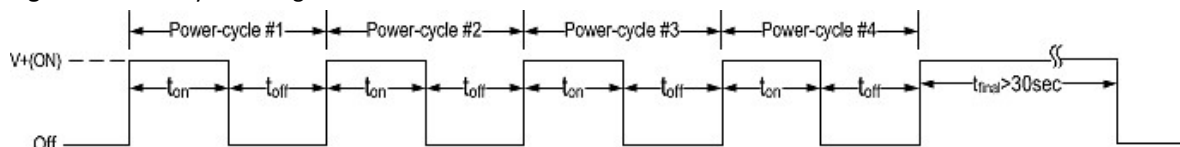

### Where:

V+(ON)

### Is:

Power through PoE has been applied to the device

Off

Power through PoE has been removed from the device

$t_{on}$

Time duration for which the device has been powered on. This should be 3-5 seconds.

$t_{off}$

Time duration for which the device has been powered off. This should be 3-5 seconds.

---

## Glossary

---

Term	Definition
AES	Advanced Encryption Standard
ANSI	American National Standards Institution
ARP	Address Resolution Protocol
ATPC	Automatic Transmit Power Control
Aux	Auxiliary
BW	Bandwidth
DC	Direct Current
DFS	Dynamic Frequency Selection
DHCP	Dynamic Host Configuration Protocol
EIRP	Equivalent Isotropic Radiated Power
EMC	Electromagnetic Compatibility
EMD	Electro-Magnetic Discharge
ETSI	European Telecommunications Standards Institute
EU	European Union
FCC	Federal Communications Commission
GUI	Graphical User Interface
HTTP	Hypertext Transfer Protocol
IC	Industry Canada
ICMP	Internet Control Message Protocol
IEEE	Institute of Electrical and Electronic Engineers
IP	Internet Protocol
ISM	Industrial Scientific and Medical
LLDP	Link Layer Discovery Protocol
LAN	Local Area Network
LOS	Line-of-Sight (clear line-of-sight, and Fresnel zone is clear)
MAC	Medium Access Control Layer
MIB	Management Information Base
MIMO	Multiple-Input Multiple-Output

<b>Term</b>	<b>Definition</b>
MTU	Maximum Transmission Unit
NLOS	Non-Line-of-Sight
NTP	Network Time Protocol
ODU	Outdoor Unit
OFDM	Orthogonal Frequency Division Multiplex
PC	Personal Computer
POE	Power over Ethernet
PSU	Power Supply Unit
PTP	Point-to-Point
QAM	Quadrature Amplitude Modulation
QoS	Quality of Service
QPSK	Quadrature Phase Shift Keying
RADIUS	Remote Authentication Dial-In Service
RAM	Random Access Memory
RF	Radio Frequency
RFC	Request for Comments
RoW	Rest of World
RMA	Return Material Authorization
RSSI	Received Signal Strength Indication
SFP	Small Form-factor Pluggable
SNMP	Simple Network Management Protocol
Syslog	System Logging
TCP	Transmission Control Protocol
TDD	Time Division Duplexing
TDWR	Terminal Doppler Weather Radar
TLS	Transport Layer Security
UNII	Unlicensed National Information Infrastructure
URL	Universal Resource Location
UTC time	Coordinated Universal Time
VLAN	Virtual Local Area Network
WEEE	Waste Electrical and Electronic Equipment