

QSG TRB143

[Main Page](#) > [TRB Gateways](#) > [TRB143](#) > **QSG TRB143**

This Wiki page contains the online version of the **Quick Start Guide (QSG)** for the **TRB143 M-Bus LTE Gateway**. Here you will find an overview of the various components on the front and back of a TRB143 device, hardware installation instructions, first login information, device specifications, and general safety information. It is highly recommended to acquaint yourself with the Quick Start Guide before using the device. You can also locate a printed version of the Quick Start Guide in the packaging box of your device.



Contents

- [1 Safety information](#) 
- [1.1 General](#)
- [1.2 RF exposure](#)  
- [1.3 Operating conditions](#)
- [1.4 Faulty and damaged products](#)
- [1.5 Electrical safety](#)
- [1.6 Product handling](#)
- [2 Front view](#)
- [3 Back view](#)
- [4 Connectors](#)
- [5 Video Quick Start Guide](#)
- [6 Hardware installation](#)
- [7 Configure your computer \(Windows\)](#)
- [8 Login to device](#)
- [9 SIM card recommendations](#)

Safety information

Before starting operating the device, please review recommendations and precautions to minimize the possibility of accidents. Safety precautions presented are supplementary and subject to the local safety regulations. When various operations are executed on the device, the user must fully follow the safety instructions and recommendations provided with the device.

General

Radio specifications

RF technologies 2G, 3G, 4G

Max RF power 33 dBm@GSM, 24 dBm@WCDMA, 23 dBm@LTE

Bundled accessories specifications*

Power adapter Input: 0.6 A@100-240 VAC, Output: 12VDC, 1.5 A, 4-pin plug

Mobile antenna 699-868/1850-2690 MHz, 50 Ω, VSWR<3, gain** 1 dBi, omnidirectional, SMA male connector

* Order code dependant.

** Higher gain antenna can be connected to compensate for cable attenuation when a cable is used. The user is responsible for the compliance with the legal regulations.





TRB143 gateway must be used in compliance with any and all applicable national and international laws and with any special restrictions regulating the utilization of the communication module in prescribed applications and environments.

CE Declaration of Conformity

[BG] Bulgarian	С настоящето, TELTONIKA NETWORKS декларира, че TRB143 е в съответствие със съществените изисквания и другите приложими разпоредби на Директива 2014/53/EU
[HR] Croatian	Ovim TELTONIKA NETWORKS izjavljuje da je ovaj TRB143 u skladu s bitnim zahtjevima i ostalim relevantnim odredbama Direktive 2014/53/EU
[CZ] Czech	TELTONIKA NETWORKS tímto prohlašuje, že TRB143 splňuje základní požadavky a všechna příslušná ustanovení Směrnice 2014/53/EU
[DK] Danish	Undertegnede TELTONIKA NETWORKS erklærer herved, at følgende udstyr TRB143 overholder de væsentlige krav og øvrige relevante krav i direktiv 2014/53/EU
[NL] Dutch	Hierbij verklaart TELTONIKA NETWORKS dat het toestel I TRB143 in overeenstemming is met de essentiële eisen en de andere relevante bepalingen van richtlijn 2014/53/EU
[EE] Estonian	Käesolevaga kinnitab TELTONIKA NETWORKS seadme TRB143 vastavust direktiivi 2014/53/EU põhinõuetele ja nimetatud direktiivist tulenevatele teistele asjakohastele sätetele
[FI] Finish	TELTONIKA NETWORKS vakuuttaa täten että TRB143 tyyppinen laite on direktiivin 2014/53/EU oleellisten vaatimusten ja sitä koskevien direktiivin muiden ehtojen mukainen
[FR] French	TELTONIKA NETWORKS déclare que cette TRB143 est conforme aux exigences essentielles et aux autres dispositions pertinentes de la directive 2014/53/EU
[DE] German	Hiermit erklärt TELTONIKA NETWORKS, dass dieser TRB143 den grundlegenden Anforderungen und anderen relevanten Bestimmungen der Richtlinie 2014/53/EU entspricht
[GR] Greek	ΜΕ ΤΗΝ ΠΑΡΟΥΣΑ Ο ΚΑΤΑΣΚΕΥΑΣΤΗΣ TELTONIKA NETWORKS ΔΗΛΩΝΕΙ ΟΤΙ ΤΗΝ ΤΡΒ143 ΣΥΜΜΟΡΦΩΝΕΤΑΙ ΠΡΟΣ ΤΙΣ ΟΥΣΙΩΔΕΙΣ ΑΠΑΙΤΗΣΕΙΣ ΚΑΙ ΤΙΣ ΛΟΙΠΕΣ ΣΧΕΤΙΚΕΣ ΔΙΑΤΑΞΕΙΣ ΤΗΣ ΟΔΗΓΙΑΣ 2014/53/EU
[HU] Hungarian	A TELTONIKA NETWORKS ezzenel kijelenti, hogy a TRB143 típusú berendezés teljesíti az alapvető követelményeket és más 2014/53/EU irányelvben meghatározott vonatkozó rendelkezéseket
[IE] Irish	Leis seo, dearbhaíonn TELTONIKA NETWORKS go gcomhlíonann an TRB143 seo bunriachtanais agus forálacha ábhartha eile Threoir 2014/53/EU
[IT] Italian	Con la presente, TELTONIKA NETWORKS dichiara che questo TRB143 è conforme ai requisiti essenziali e ad altre disposizioni pertinenti della Direttiva 2014/53/EU
[LV] Latvian	Ar šo TELTONIKA NETWORKS deklarē, ka TRB143 atbilst Direktīvas 2014/53/EU būtiskajām prasībām un citiem ar to saistītajiem noteikumiem
[LT] Lithuanian	Šiuo dokumentu UAB TELTONIKA NETWORKS deklaruoja, kad šis TRB143 atitinka esminius reikalavimus ir kitas 2014/53/EU Direktyvos nuostatas

[MT] Maltese	Hawnhekk, TELTONIKA NETWORKS tiddikjara li dan l-TRB143 huwa konformi mar-rekwiżiti essenzjali u dispozizzjonijiet rilevanti oħra tad Direttiva 2014/53/EU
[NO] Norwegian	TELTONIKA NETWORKS Erklærer herved at TRB143 er i samsvar med de grunnleggende krav og øvrige relevante krav i direktiv 2014/53/EU
[PL] Polish	Niniejszym TELTONIKA NETWORKS deklaruje że TRB143 jest zgodny z zasadniczymi wymaganiami i innymi właściwymi postanowieniami Dyrektywy 2014/53/EU
[PT] Portuguese	Eu, TELTONIKA NETWORKS declaro que o TRB143 cumpre os requisitos essenciais e outras provisões relevantes da Directiva 2014/53/EU
[RO] Romanian	Prin prezenta, TELTONIKA NETWORKS declară că aparatul TRB143 este în conformitate cu cerințele esențiale și cu alte prevederi pertinente ale Directivei 2014/53/EU
[SK] Slovak	Spoločnosť TELTONIKA NETWORKS týmto vyhlasuje, že smerovač TRB143 je v súlade so základnými požiadavkami a ďalšími príslušnými ustanoveniami smernice 2014/53/EU
[SI] Slovenian	TELTONIKA NETWORKS izjavlja, da je ta TRB143 v skladu z bistvenimi zahtevami in drugimi relevantnimi določili direktive 2014/53/EU
[ES] Spanish	Por la presente, TELTONIKA NETWORKS declara que este TRB143 cumple con los requisitos esenciales y otras exigencias relevantes de la Directiva 2014/53/EU
[SE] Swedish	Härmed intygar TELTONIKA NETWORKS att denna TRB143 är i överensstämmelse med de väsentliga egenskapskrav och övriga relevanta bestämmelser som framgår av direktiv 2014/53/EU

Detailed compliance information is available at the following internet address: wiki.teltonika-networks.com/view/Certificates.

-  This sign on the package means that it is necessary to read the User's Manual before you start using the device.
-  This sign on the package means that all used electronic and electric equipment should not be mixed with general household waste.
-  Hereby, TELTONIKA NETWORKS declares that this TRB143 is in compliance with the essential requirements and other relevant provisions of Directive 2014/53/EU. The full text of the EU declaration of conformity is available at the following internet address: https://wiki.teltonika-networks.com/view/TRB143_CE/RED.
-  Hereby, TELTONIKA NETWORKS declares that the radio equipment type TRB143 is in compliance with Radio Equipment Regulations 2017. The full text of the UK declaration of conformity is available at the following internet address: https://wiki.teltonika-networks.com/view/TRB143_UKCA.

RF exposure

This device meets the official requirements for exposure to radio waves. This device is designed and manufactured not to exceed the emission limits for exposure to radio frequency (RF) energy set by authorized agencies. The device must be used with a minimum separation of 20 cm from a person's

body to ensure compliance with RF exposure guidelines. Failure to observe these instructions could result in your RF exposure exceeding the applicable limits.

External antennas used with TRB143 must be installed to provide a distance of at least 20 cm from any people and must not be co-located or operated in conjunction with any other antenna or transmitter.

Any external antenna gain must meet RF exposure and maximum radiated output power limits of the applicable rule section.

Maximum transmission power

GSM	33 dBm
WCDMA	24 dBm
LTE	23 dBm

Operating conditions

- Operating temperature: -40° to +75° Celsius
- Humidity should be in the range of 10% to 90% (non-condensing). Only use the device in dry environments.
- Out of direct sunlight
- Away from heat source, corrosive substances, salts, and flammable gases

Attention: operation outside the permissible range can considerably shorten the service life of the device.

Faulty and damaged products

- Do not attempt to disassemble the device or its accessories.
- Only qualified personnel must service or repair the device or its accessories.
- If your device or its accessories have been submerged in water punctured or subjected to a severe fall, do not use until they have been checked at an authorized service center.

Electrical safety

- Only use approved accessories.
- Do not connect with incompatible products or accessories.
- It is recommended to ground devices with grounding terminals before connecting them to power. Failure to ground appropriately might result in a shock hazard. The cross-sectional area of the protective grounding conductor should be at least 1mm².

Product handling

- You alone are responsible for how you use your device and any consequences related to its

use.

- Use of your device is subject to safety measures designed to protect users and their environment.
- Always treat your device and its accessories with care and keep it in a clean and dust-free place.
- Do not expose your device or its accessories to open flames, lit tobacco products, liquid, moisture, or high humidity.
- Do not drop, throw or try to bend your device or its accessories.
- Do not use harsh chemicals, cleaning solvents, or aerosols to clean the device or its accessories.
- Do not paint your device or its accessories.
- Do not attempt to disassemble your device (exemptions for devices that require disassembly for SIM insertion) or its accessories: it does not contain any user-serviceable parts. For safety reasons, the equipment should be opened only by qualified personnel.
- Make sure to use ESD personal protective equipment while the equipment is serviced.
- Do not use your device in an enclosed environment where heat dissipation is poor.
- Prolonged use in such space may cause excessive heat and raise ambient temperature, which will lead to the automatic shutdown of your device or the disconnection of the mobile network connection for your safety. To use your device again after such a shutdown, cool it in a well-ventilated place before turning it on.
- Please check all national laws and local regulations for the disposal of electronic products.
- Do not operate the device where ventilation is restricted.
- Do not use or install this product near water to avoid fire or shock hazards.
- Avoid exposing the equipment to rain or damp areas.
- Arrange power and Ethernet cables so that they are not likely to be stepped on or have items placed on them.
- Ensure that the voltage and the rated current of the power source match the device's requirements. Do not connect the device to an inappropriate power source.
- During a thunderstorm, no operations should be carried out on the device and cables.
- The unit must be powered off where blasting is in progress and explosive atmospheres are present or near medical life support equipment.
- Do not leave your device and its accessories within reach of small children or allow them to play with it. They could hurt themselves or others and could accidentally damage the device. Your device contains small parts with sharp edges that may cause an injury choking hazard.
- Like any wireless device, this device operates using radio signals, which cannot guarantee connection in all conditions. Therefore, you must never rely solely on any wireless device for emergency communications or otherwise use the device in situations where the interruption of data connectivity could lead to death, personal injury, property damage, data, or other loss.
- The device may become warm during regular use.

Front view

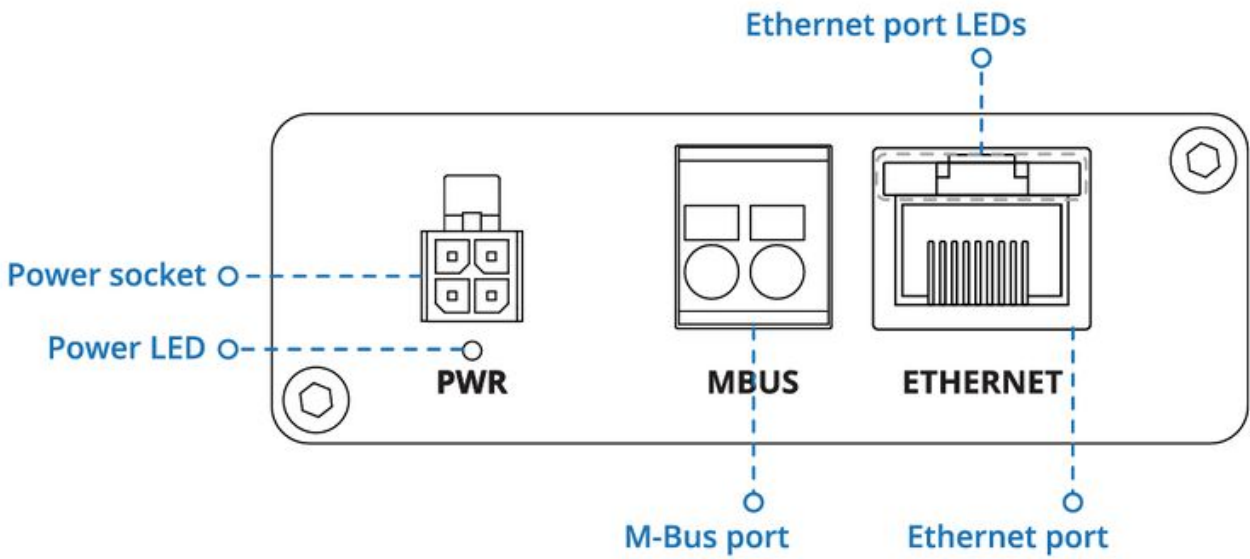

Back view

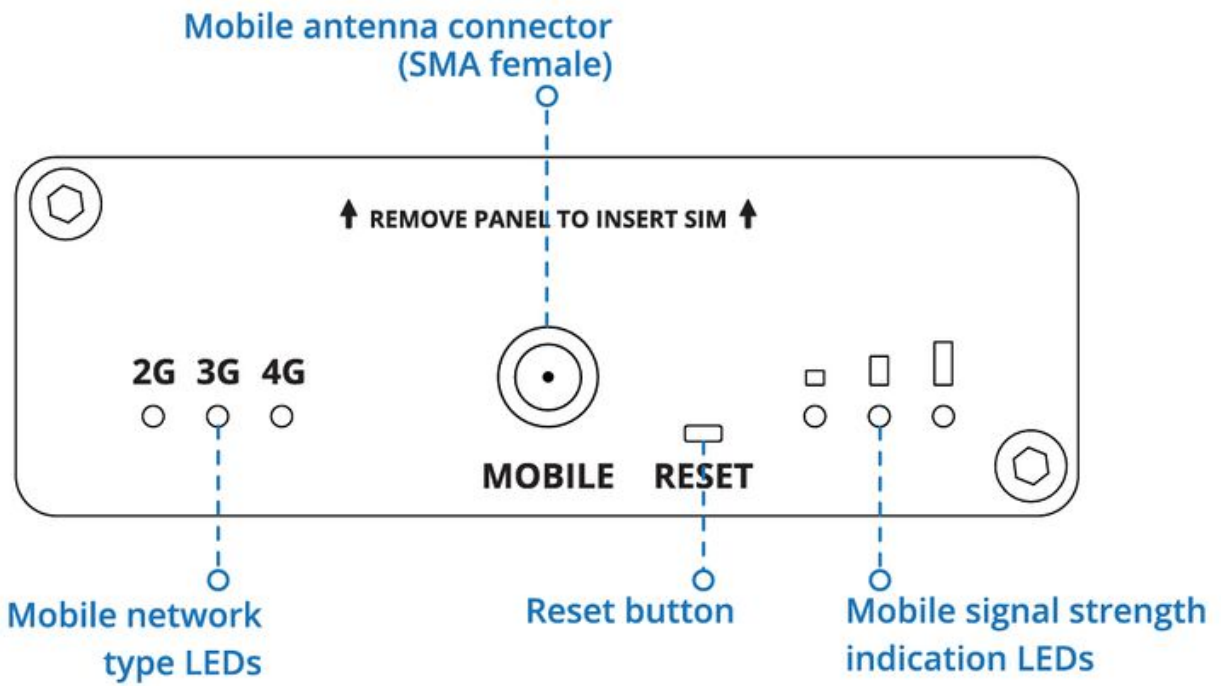

Connectors

POWER SOCKET PINOUT



Video Quick Start Guide

Need some help setting up your Teltonika Networks TRB143 M-BUS cellular gateway? Watch our quick start guide video and follow the step-by-step instructions to easily set up your new device for operation.

Hardware installation

1. Unscrew the two hex bolts and remove the back panel.

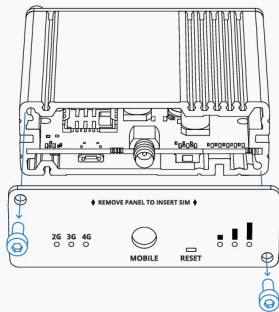

2. Insert your SIM card into the SIM socket.

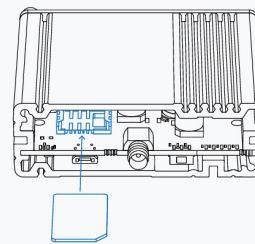

3. Re-attach the back panel and screw in the hex bolts.

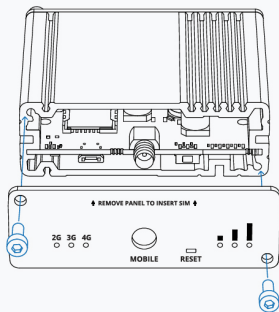

4. Attach the Mobile antenna to the connector labeled "MOBILE".

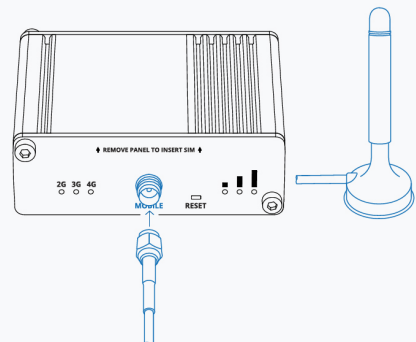

5. Connect the 4-pin connector to the power socket on the front of the device. Then plug the power adapter into an electric outlet.

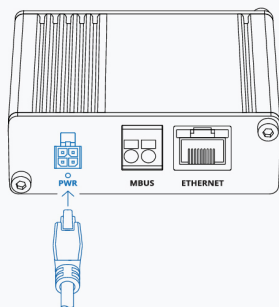

6. Connect to the device with an Ethernet cable connected to the LAN port.

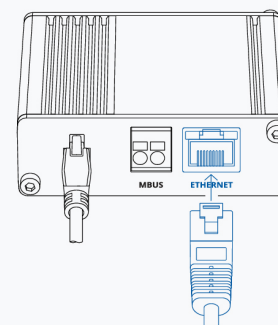

Configure your computer (Windows)

1. Ensure the Network connection is Enabled. Go to Start — Control Panel — Network and Internet — Network and Sharing Center. Click on the **Change adapter settings** in the left panel, then right-click on Network Adapter, and select Enable.

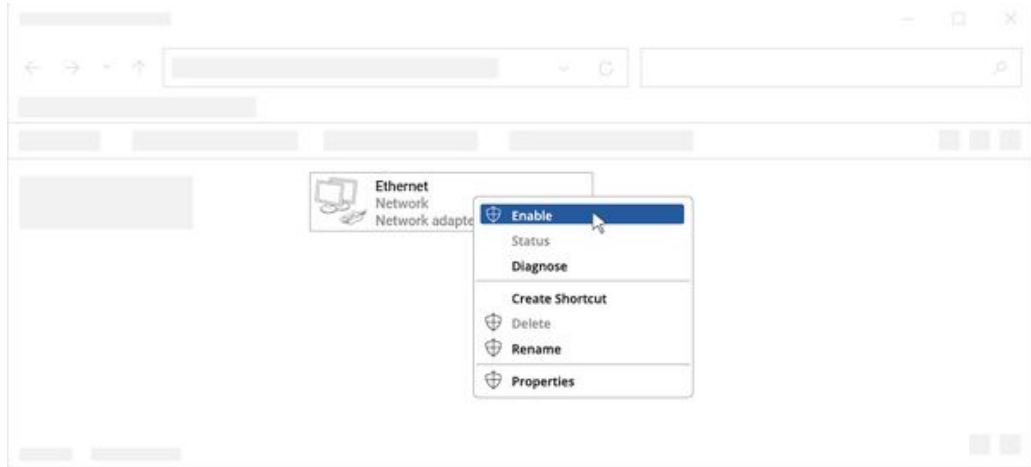

2. Check if IP and DNS are obtained automatically. Right-click on Network Adapter and select Properties. Then select **Internet Protocol Version 4** and click Properties.

3. If not selected, check to **obtain an IP address** and **obtain DNS server address automatically**. Click OK.



Login to device

1. To enter the gateway's Web interface (WebUI), type <http://192.168.2.1> into the URL field of your Internet browser.

2. When prompted for authentication enter the username admin and enter the password located on the device information label/engraving.

3. After logging in, you must set a new password for security reasons. You will not be able to interact with the gateway's WebUI until the default password is changed. The new password must consist of a minimum of **8 characters**. Requirements: one uppercase letter, one lowercase letter, and one digit. 

4. Next, the Configuration Wizard will start to help you set up some of the gateway's main operational parameters.

5. Finally, let's verify the Mobile signal strength. Go to the **Status – Network** page and pay attention to the **Signal Strength** indication.

To achieve the best signal conditions and maximize cellular performance, try adjusting the antennas or changing the location of your device. You can find information on signal strength recommendations [here](#).

SIM card recommendations

- Before installing the SIM cards, please apply a thin layer of dielectric grease to the SIM card contacts for devices used in environments with **high-vibration levels**. This will help avoid SIM cards losing touch with the SIM slot and prevent unexpected failures.
- Industrial Grade SIM cards are recommended for devices requiring a long lifespan used in

environments with **extreme temperatures, corrosive** or **extra humid climates**, or hard-to-reach locations.