

Installation Guide

Omada Multi-Gigabit VPN Router



Note: The image may differ from the actual product.

- To ask questions, find answers, and communicate with TP-Link users or engineers, please visit <https://community.tp-link.com> to join TP-Link Community.
- For technical support and other information, please visit <https://www.tp-link.com/support>, or simply scan the QR code.

© 2023 TP-Link 7106510150 REV1.1.0

1 Hardware Overview

Front Panel

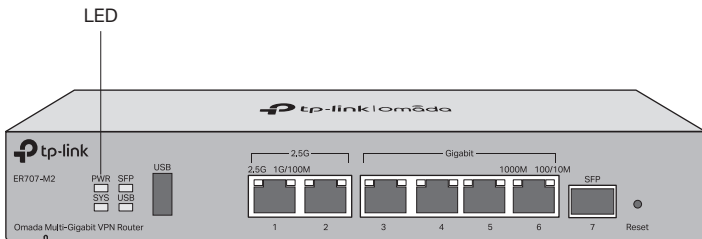

- Reset:** Press and hold the button for 5 seconds, the SYS LED will flash quickly, indicating the device is being reset to its factory default settings.

Back Panel

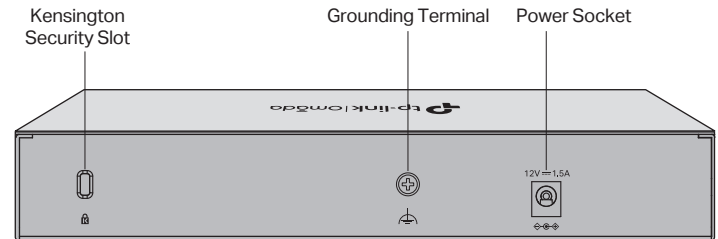

Interface	Description
USB	USB 2.0 for USB modem and USB storage device.
Port 1	2.5G RJ45 WAN port.
Port 2	2.5G RJ45 WAN/LAN port. By default, it is a LAN port connecting to local PCs or switches. You can configure it to a WAN port on the management page.
Port 3	Gigabit RJ45 WAN/LAN port. By default, it is a WAN port. You can configure it to a LAN port on the management page.
Ports 4-6	Gigabit RJ45 WAN/LAN ports. By default, they are LAN ports connecting to local PCs or switches. You can configure each port to a WAN port on the management page.
Port 7	Gigabit SFP WAN/LAN port connecting to an SFP module. By default, it is a LAN port. You can configure it to a WAN port on the management page.
Kensington Security Slot	Secure the lock (not provided) into the security slot to prevent the device from being stolen.
Grounding Terminal	The router comes with a lightning protection mechanism.
Power Socket	Connect to the power outlet via the provided power adapter.

LED	Indication
PWR	On: Power is on. Off: Power is off.
SYS	Slow Flashing: System is running normally. Quick Flashing: The router is being reset. On/Off: System is starting up or running abnormally.
SFP	On: Running at 1000 Mbps, but no activity. Off: No device is linked to the corresponding port. Flashing: Running at 1000 Mbps, and transmitting or receiving data.
USB	For USB Modem: Flashing: A modem is connected, and it is initializing. On: The modem is loaded. Off: No modem is inserted, or it is corrupted or incompatible. For USB Storage: On: A USB storage device is inserted and identified. Off: No USB storage device is inserted, or it is corrupted or incompatible.
Link/Act	For 2.5G Port: Green On: Running at 2.5 Gbps, but no activity. Green Off: No device is linked to the corresponding port. Green Flashing: Running at 2.5 Gbps, and transmitting or receiving data. Yellow On: Running at 1000/100/10 Mbps, but no activity. Yellow Off: No device is linked to the corresponding port. Yellow Flashing: Running at 1000/100/10 Mbps, and transmitting or receiving data. For Gigabit Port: Green On: Running at 1000 Mbps, but no activity. Green Off: No device is linked to the corresponding port. Green Flashing: Running at 1000 Mbps, and transmitting or receiving data. Yellow On: Running at 100/10 Mbps, but no activity. Yellow Off: No device is linked to the corresponding port. Yellow Flashing: Running at 100/10 Mbps, and transmitting or receiving data.

2 Hardware Connection

Connect via Ethernet

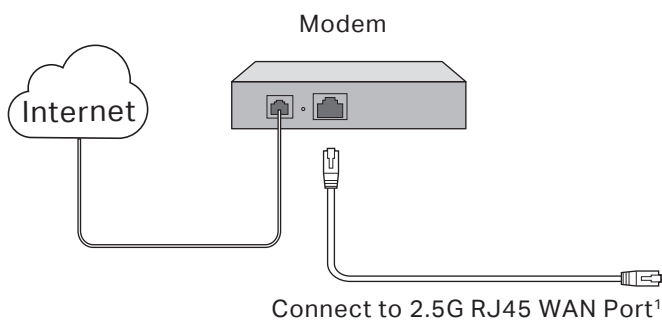

Connect via fiber network

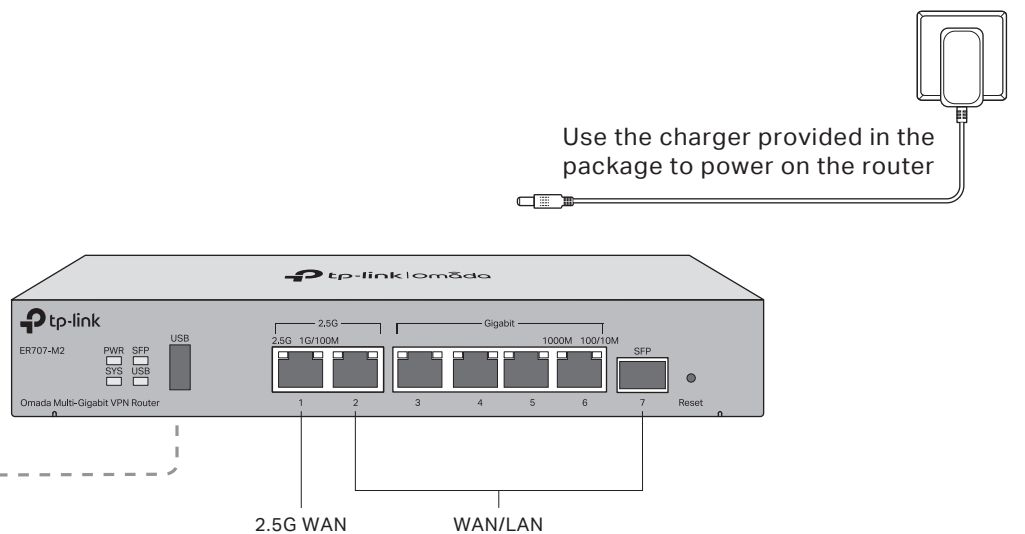
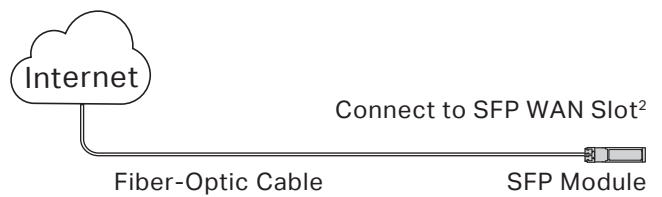

- Note:
- If you want to connect to the internet via another RJ45 WAN port, refer to [FAQ-Q1](#) to configure your desired port to a WAN port first (excluding port 3), and connect the port to the internet via an RJ45 cable.
 - For internet connection via fiber network, refer to [FAQ-Q1](#) to configure the SFP port as a WAN port first, and connect the SFP port to the internet via an SFP module.

3 Software Configuration

The router supports two configuration options:

- Standalone Mode:** Configure and manage the router by itself.
- Controller Mode:** Configure and manage network devices centrally. It is recommended in large-scale networks, which consist of a large number of devices such as access points, switches, and gateways.

Note: When the router is managed by a controller, configurations of the router will be overridden by the controller.

Option 1: Standalone Mode

In Standalone Mode, use a computer to configure and manage the router.

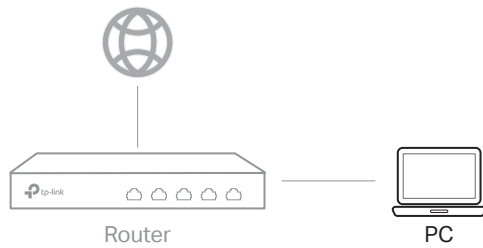

1. Connect a computer to a LAN port of the router with an RJ45 cable properly. If your computer is configured with a fixed IP, change it to **Obtain an IP address automatically**.

2. Open a web browser and type the default management address **192.168.0.1** in the address field of the browser, then press the **Enter** key.
3. Create a username and a password for subsequent login attempts and for security.
4. Use the username and password set above to log in to the webpage.

5. After a successful login, you can configure the function by clicking the setup menu on the left side of the screen.

Note: Make sure the ports you select as WAN ports correspond to the real situation.

For detailed configurations, refer to the User Guide of the router. The guide can be found on the download center of our official website: <https://www.tp-link.com/support/download/>.

Option 2: Controller Mode Choose from the following two types of Omada Controller:

Type 1: Via Omada Hardware Controller

The Omada Hardware Controller (e.g., OC200/OC300, purchased separately) is a good alternative if you have no spare PC to run the Omada Software Controller.

For more details, refer to the Installation Guide of your Omada Hardware Controller.

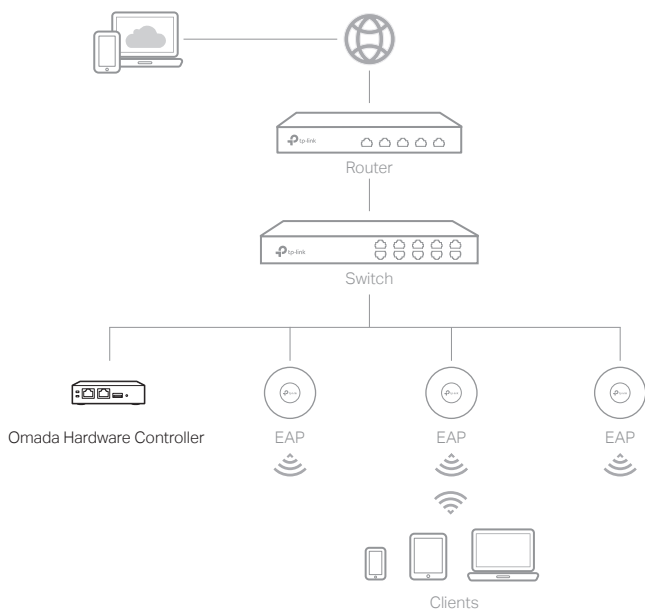

1. As Omada Hardware Controller gets its IP address from the DHCP server of the router, we don't know its IP address explicitly. However, we can find it out on the router's DHCP client list.

- a. You need first find the IP address of the router. Open the command line on your PC and enter **ipconfig**. In the result list, find the **Default Gateway**, which is also the IP address of the router.
- b. Launch a web browser and enter the IP address of the router. Create a username and password, and log into the router's web page. Then go to **Network > LAN > DHCP Client List** to find the IP address of your controller according to its MAC address.
- c. Enter the IP address of your controller in the address bar to open its web page.

2. On the Omada Controller's web page, follow the wizard to complete the quick setup.

Note: When configuring the router, make sure the ports you select as WAN ports correspond to the real situation.

3. After the quick setup, the login page appears. Enter the username and password you have created and click **Log in**. Then you can further configure the controller.

4. (For Remote Management) You can remotely access and manage your controller via Omada Cloud Service.
 - a. Make sure that **Cloud Access** is enabled on your controller. By default, Cloud Access is enabled. Make sure that the Cloud LED is flashing slowly.
 - b. Launch a web browser and enter <https://omada.tp-linkcloud.com> in the address bar. Enter your TP-Link ID and password to log in. Click **+ Add Controller** and choose **Hardware Controller** to add your controller. Then you can further configure the controller.

* Omada App

With Omada App, you can also manage your controller at a local site or a remote site via your mobile device.



Type 2: Via Omada Software Controller

The Omada Software Controller is free software for centralized management. To centrally manage your devices, the Omada Software Controller needs to continually run on your computer.

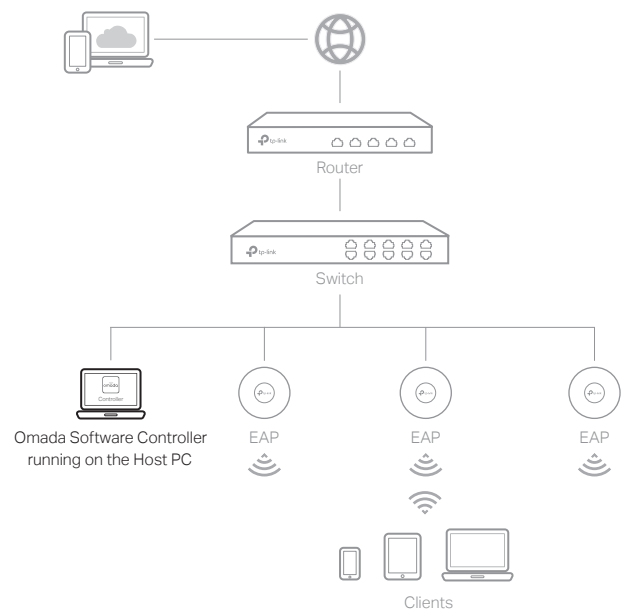

1. On a PC with Windows OS or Linux OS, download the Omada Software Controller installation file from <https://www.tp-link.com/support/download/omada-software-controller/>.

Note: To download Omada Software Controller successfully, it is recommended to configure the router's network to access the internet. Refer to Standalone Mode to launch the management page and go to **Network > WAN** to complete the configuration.

2. Run the file and follow the wizard to install the Omada Software Controller.
3. Launch the Omada Software Controller and follow the step-by-step instructions to complete the quick setup.

Note: When configuring the router, make sure the ports you select as WAN ports correspond to the real situation.

4. After the quick setup, the login page appears. Enter the username and password you created and click **Log in**. Then you can further configure the network.

Omada Cloud Portal

After installing Omada Software Controller, you can remotely access the controller through Omada Cloud Portal. Follow the steps below.

- a. Enable **Cloud Access** on the setting page on the controller and bind a TP-Link ID to your controller. If you have configured this in the setup wizard, skip the step.
- b. Launch a web browser and enter <https://omada.tp-linkcloud.com> in the address bar.
- c. Enter your TP-Link ID and password to log in. A list of controllers that have been bound with your TP-Link ID will appear. Then you can click **Launch** to further configure the controller.

For the detailed configurations, refer to the User Guide of the controller. The guide can be found on the download center of our official website: <https://www.tp-link.com/support/download/>.

Frequently Asked Questions (FAQ)

Q1. What should I do if I want to change the mode of the WAN/LAN ports?

Follow the steps:

1. (Recommended) Refer to the Interface Description table of this guide for the default mode of the WAN/LAN ports.
2. Connect a computer to a LAN port of this router. If your computer is configured with a fixed IP address, change it to **Obtain an IP address automatically**.
3. Log in to this router's management page at **192.168.0.1**. Go to **Network > WAN > WAN Mode**, change the mode of the WAN/LAN ports by ticking the checkboxes, and click **Save**.

Q2. What should I do if I need to connect this router to a modem router?

Check the LAN IP address of the modem router first. If the LAN IP address of the modem router is **192.168.0.1**, which is the same as the default LAN IP address of this router, follow the steps to change the LAN IP address of this router:

1. Connect a computer to a LAN port of this router. If your computer is configured with a fixed IP address, change it to **Obtain an IP address automatically**.
2. Log in to this router's management page at **192.168.0.1**, and go to **Network > LAN > LAN**. In the **Network List** section, change the IP address **192.168.0.1** to **192.168.1.1**, and click **OK**.

Safety Information

- Keep the device away from water, fire, humidity or hot environments.
- Do not attempt to disassemble, repair, or modify the device. If you need service, please contact us.
- Do not use damaged charger or USB cable to charge the device.
- Do not use any other chargers than those recommended.
- Adapter shall be installed near the equipment and shall be easily accessible.
- Place the device with its bottom surface downward.

EU Declaration of Conformity

TP-Link hereby declares that the device is in compliance with the essential requirements and other relevant provisions of directives 2014/30/EU, 2014/35/EU, 2011/65/EU and (EU)2015/863.

The original EU declaration of conformity may be found at <https://www.tp-link.com/en/support/ce/>.

UK Declaration of Conformity

TP-Link hereby declares that the device is in compliance with the essential requirements and other relevant provisions of the Electromagnetic Compatibility Regulations 2016 and Electrical Equipment (Safety) Regulations 2016.

The original UK declaration of conformity may be found at <https://www.tp-link.com/support/ukca/>.

