

WLAN Bluetooth PCI Express Adapter

Before You Start:

1. Make sure you are using **Windows 11(64-bit) or above**, and your Router or Access Point supports **the Wi-Fi 7 standard**.
2. If you plan on using Bluetooth and already have connected Bluetooth devices, proceed with **Step 1**. Otherwise, skip to **Step 2**.

1 Disable Bluetooth

- a. Right-click My Computer, select **Manage**, go to **Device Manager**.
- b. Expand the **Bluetooth** node to find your existing Bluetooth device.
- c. Right-click the existing Bluetooth device and select **Disable**.

Note:
Make sure you have disabled all existing Bluetooth devices (both built-in and the third party).

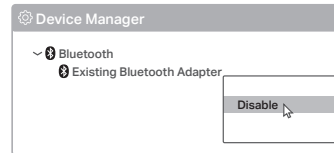

2 Connect to a Computer

- a. Turn off your computer, unplug the power cable, and then remove the case panel.
- b. Connect the provided Bluetooth USB cable to the adapter.

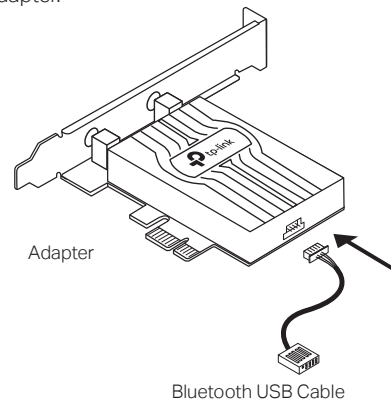

- c. Locate an available **PCIE slot (X1, X4, X8, or X16)** and carefully insert the adapter.
- Note:**
If the bracket is not suitable for your computer, detach it from the adapter's board and replace it with the low-profile bracket.

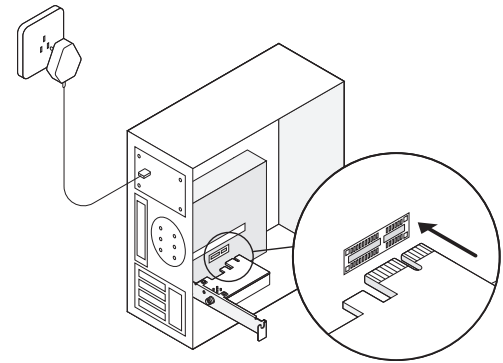

- d. Locate an available **F_USB** connector and carefully plug the Bluetooth USB cable into it.
- Note:**
If the Bluetooth USB cable is not correctly connected to the motherboard, the Bluetooth function won't work even after driver installation.

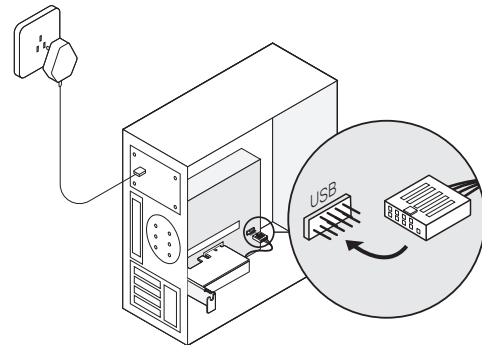

- e. Connect the antenna(s) to the adapter.
- Tip:**
To maximize performance, make sure the path between the antenna and your router is clear.

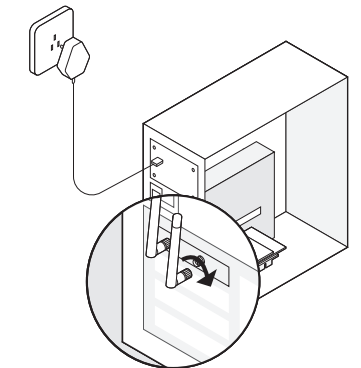

- f. Replace the case panel, plug in the power cable, and turn on your computer.

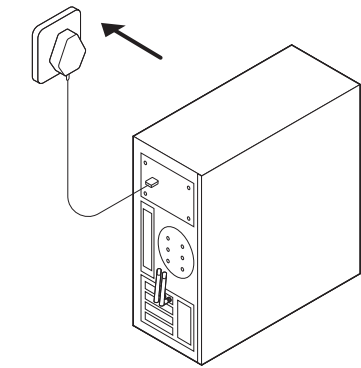

To continue, flip the page over.

3 Install Drivers

a. Insert the CD into your computer and go to **My Computer** or **This PC** to run the **Autorun.exe**.

Tip:
You can also check for new releases and download the latest drivers at <https://www.tp-link.com/support/download/>

b. Install the Wi-Fi and Bluetooth drivers.





① **Wi-Fi:** Click  and follow the on-screen instructions to complete the Wi-Fi installation.

② **Bluetooth:** Click  and follow the on-screen instructions to complete the Bluetooth installation.

Note:

- If an unknown publisher message pops up, select **Yes** to continue.
- If Windows User Account Control requires admin credentials, type the user name and password of your Windows administrator account.

4 Join a Wireless Network

a. Click the network icon on the taskbar (the icon might look like one of these: , , , or ).

b. Select your Wi-Fi network, click **Connect**, and enter the password when prompted.

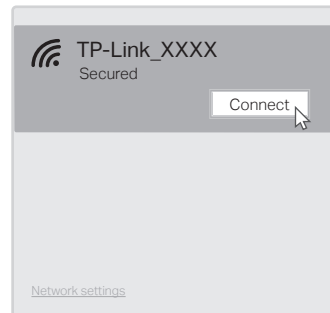

5 Pair with Bluetooth Devices

a. Right-click the  (Bluetooth) icon on the taskbar. If it's not displayed, turn on Bluetooth in your PC settings first.

b. Select **Add a Bluetooth Device** or **Add a Device** to scan for available devices.

c. Select your Bluetooth device from the list and follow the on-screen instructions to complete pairing.

Note:
Make sure your device's Bluetooth is enabled and discoverable.

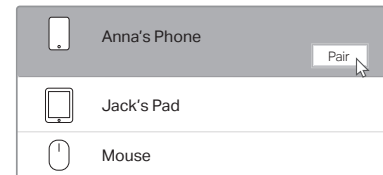

Need Help?

Q1. What should I do if the adapter is not detected?

- A1.** Make sure the adapter is securely located in the appropriate PCI-E slot.
- A2.** Try a different PCI-E slot on the computer.
- A3.** Make sure you use the latest driver for your specific adapter. The latest drivers can be found at the product's Support page at <https://www.tp-link.com/support/>
- A4.** Try restarting the computer or try the adapter on a different computer.

Q2. How do I check if I have installed the drivers successfully?

- A1.** Please follow these steps to check if you installed the driver for your TP-Link adapter successfully:
 - **Step 1.** Right-click **My Computer** or **This PC** on your computer and select **Manage**. Or click the Windows Button and type 'Device Manager' in the search bar (usually on the bottom-left corner of the Desktop), and click **Device Manager**.

- **Step 2.** Locate **Network Adapters** or **Bluetooth** and find the relevant TP-Link adapters.
- **Step 3.** Right-click the adapter and select **Properties**. If you see 'This device is working properly' in the Device Status box, then you have already installed the driver successfully.

Q3. What should I do if I can't connect to the Wi-Fi after installing the driver?

- A1.** Refer to **Q1** to check if the adapter is detected.
- A2.** Refer to **Q2** to check if you have installed the drivers for your adapter successfully.
- A3.** Disable the antivirus software and firewall, then try again.
- A4.** Reinstall the driver and try again.

Q4. What should I do if the Bluetooth icon doesn't appear?

- A1.** Make sure you have turned on the Bluetooth in your Windows settings. To enable Bluetooth, go to **Start > Settings > Devices > Bluetooth & other devices** and turn on Bluetooth.

A2. Make sure there are no other Bluetooth devices on the computer. If there are, disable all existing Bluetooth devices in Device Manager, then reinstall the adapter and try again.

Tip:
To access Device Manager: Right-click My Computer or This PC, select **Manage**, go to Device Manager, and disable all existing Bluetooth devices.



 For technical support, user guides and other information, simply scan the QR code or visit <https://www.tp-link.com/support/>

Safety Information

- Keep the device away from water, fire, humidity or hot environments.
- Do not attempt to disassemble, repair, or modify the device. If you need service, please contact us.
- Do not use the device where wireless devices are not allowed.
- This equipment can be powered only by equipments that comply with Power Source Class 2 (PS2) or Limited Power Source (LPS) defined in the standard of IEC 62368-1. TP-Link hereby declares that the device is in compliance with the essential requirements and other relevant provisions of directives 2014/53/EU, 2011 /65/EU and (EU) 2015/863. The original EU Declaration of Conformity may be found at <https://www.tp-link.com/en/support/ce>
- TP-Link hereby declares that the device is in compliance with the essential requirements and other relevant provisions of the Radio Equipment Regulations 2017. The original UK Declaration of Conformity may be found at <https://www.tp-link.com/support/ukca>

